



CITY

60008



WARNING: CHOKING HAZARD.
Toy contains small parts and a small ball.
Not for children under 3 years.





AVERTISSEMENT : RISQUE D'ÉTOUFFEMENT.

Le jouet contient des petites pièces ainsi qu'une petite boule. Il ne convient pas aux enfants de moins de 3 ans.



ADVERTENCIA: PELIGRO DE ASFIXIA.

Juguete que contiene partes pequeñas y una pelota pequeña. No recomendado para niños menores de 3 años.

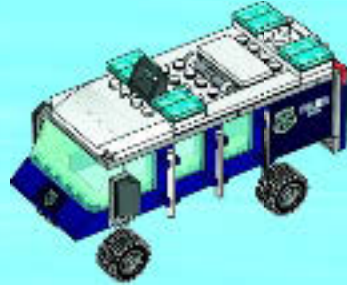

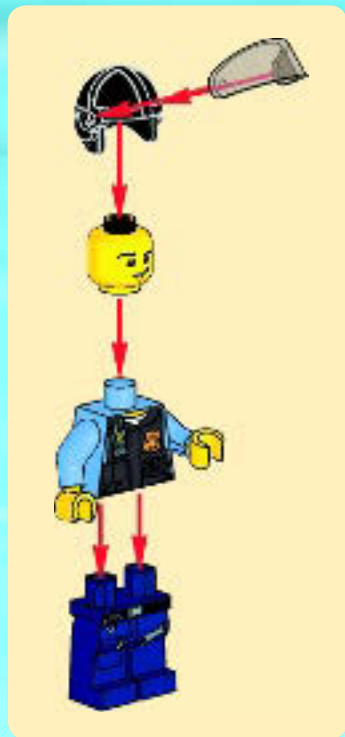

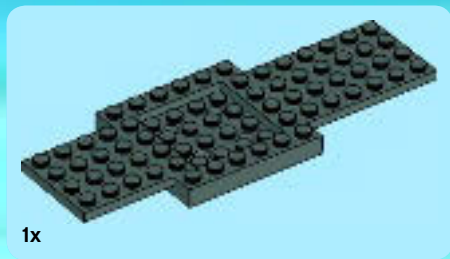

1x

1

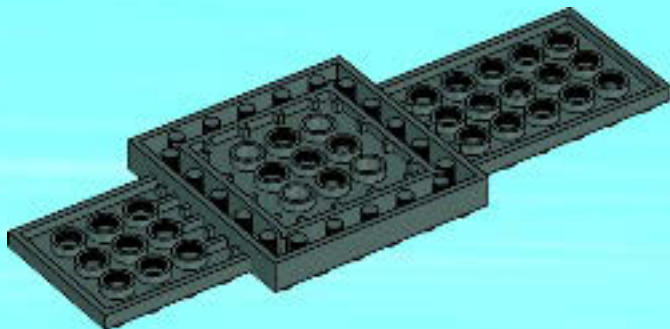



1x



1x



2x

2

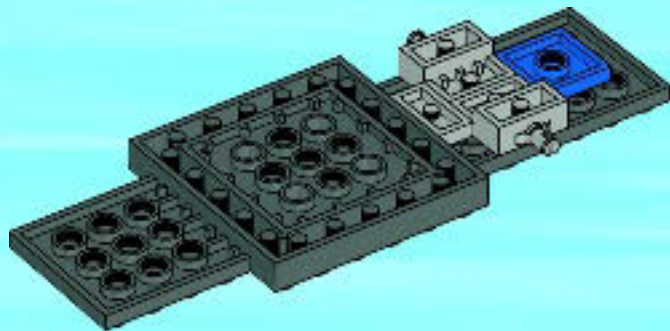



1x

3

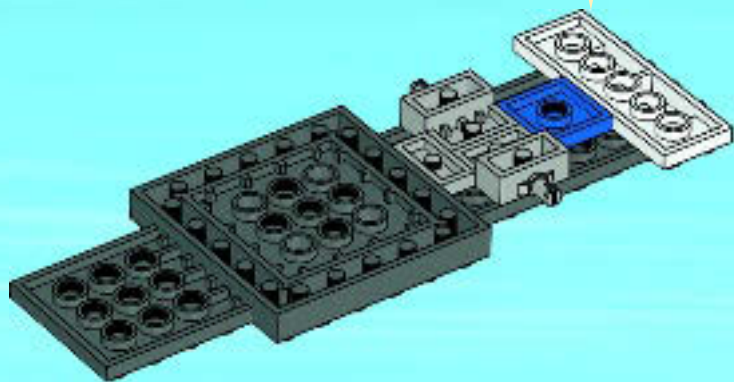
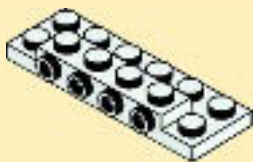

6



1x

4

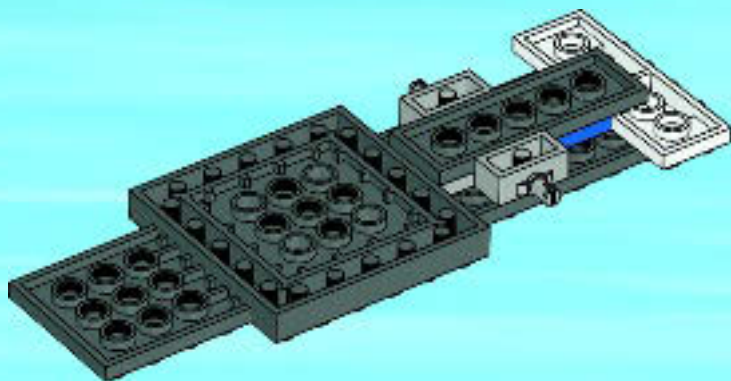



2x



2x

5

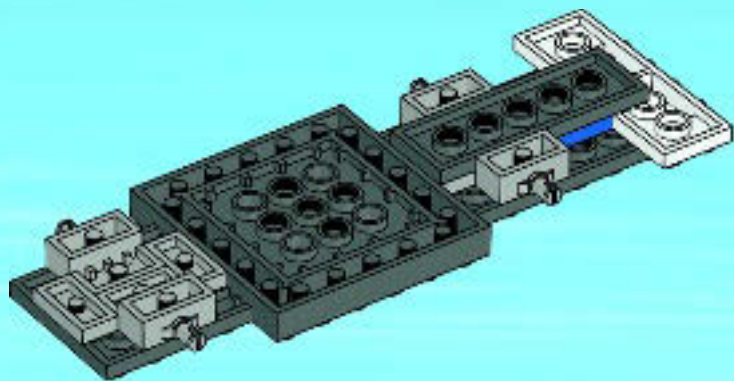

8



1x

6

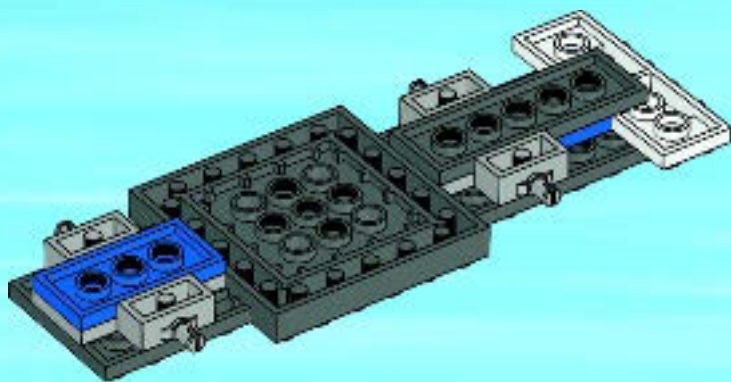



2x

7

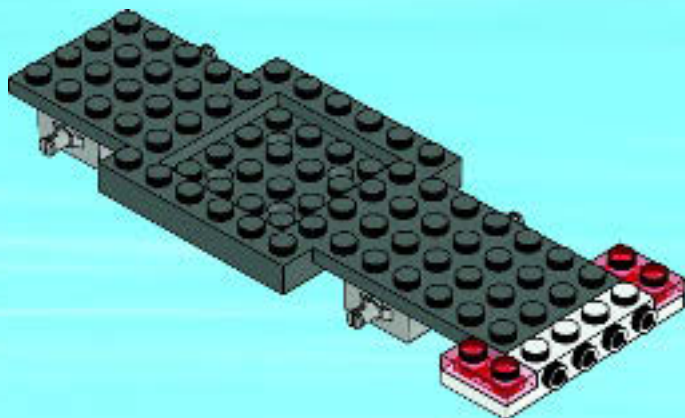



3x



1x

8

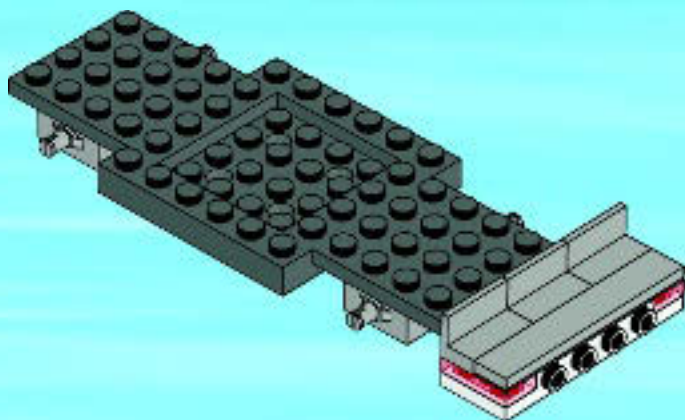



1x



2x

9

1

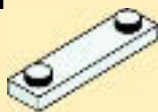

2



3

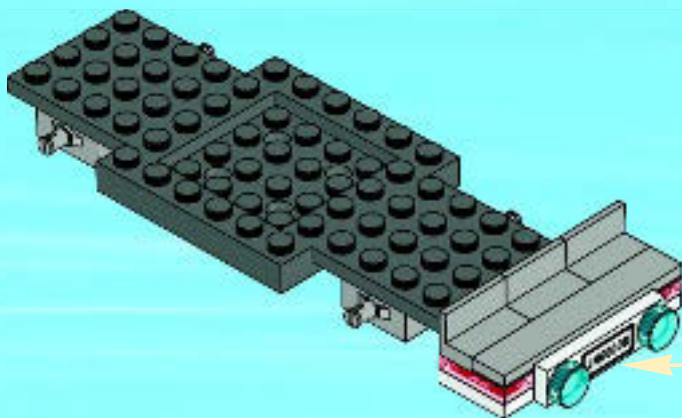



1x



2x

10

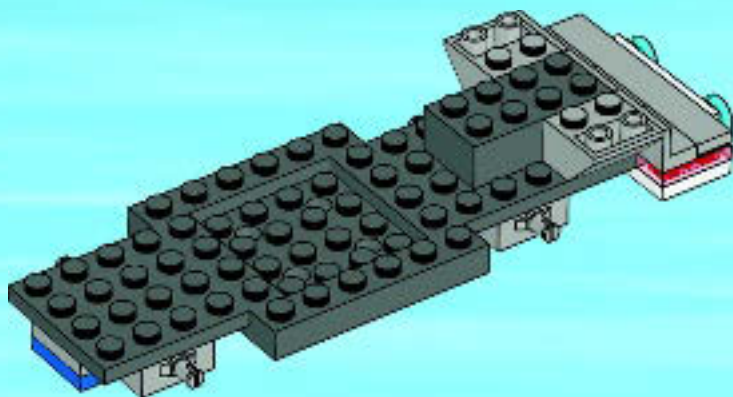



2x

11

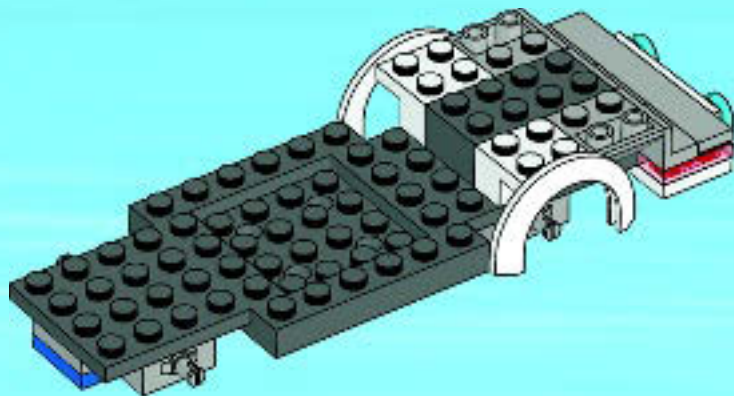



1x



2x

12

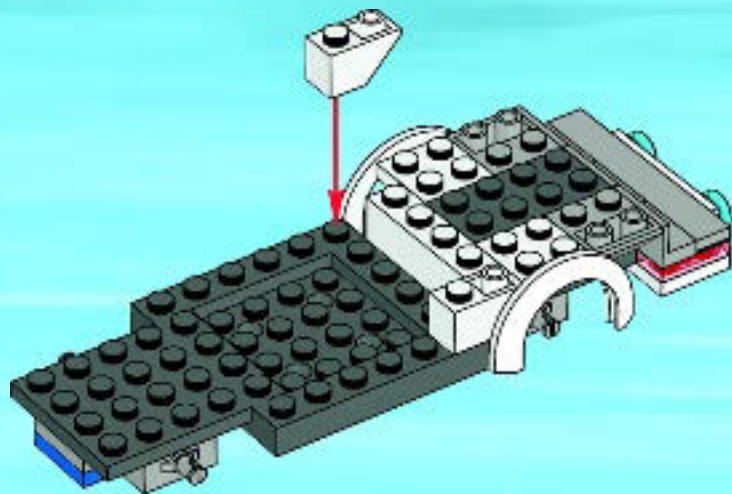



1x



4x

13

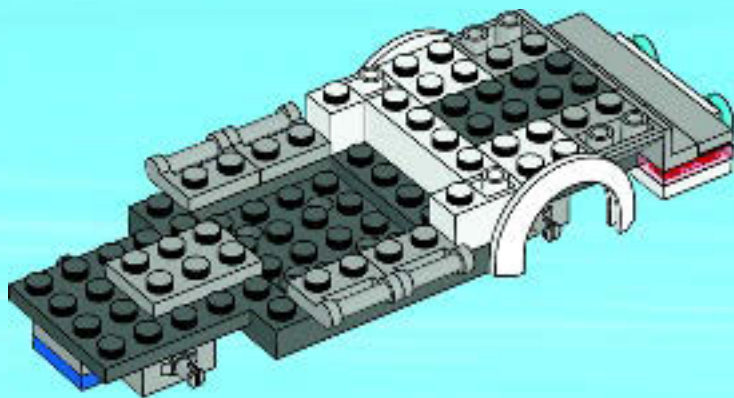



1x



2x

14

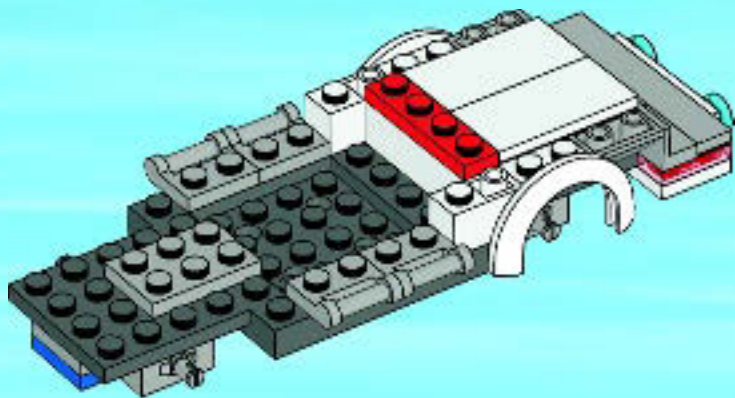



2x



2x

15

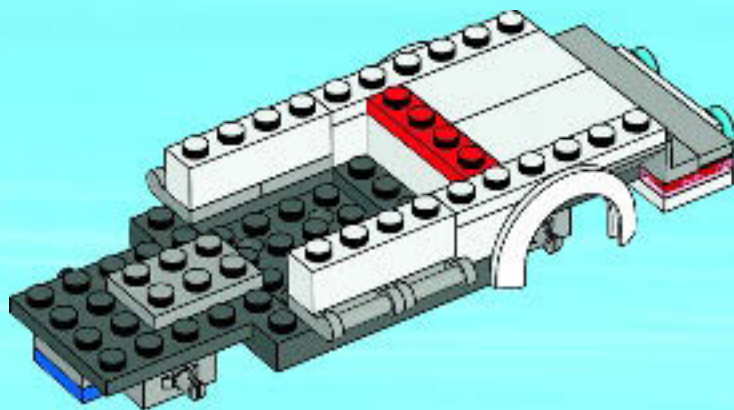



2x

16

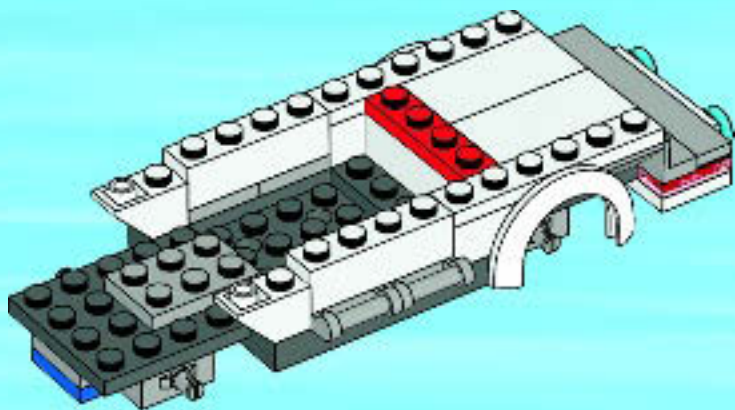



1x



2x

17

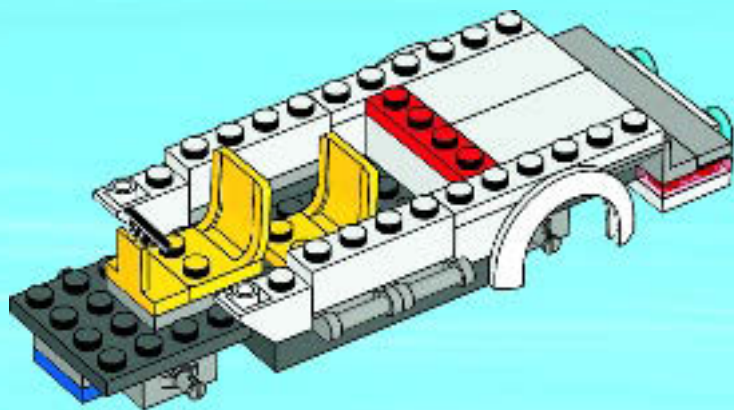



1x



2x

18

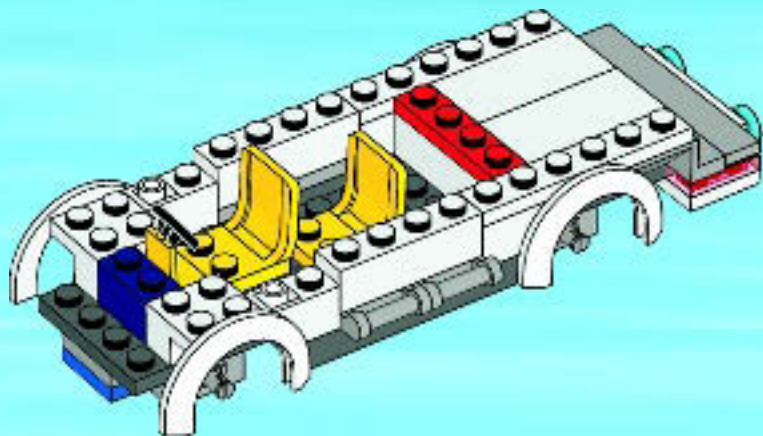



2x



1x

19

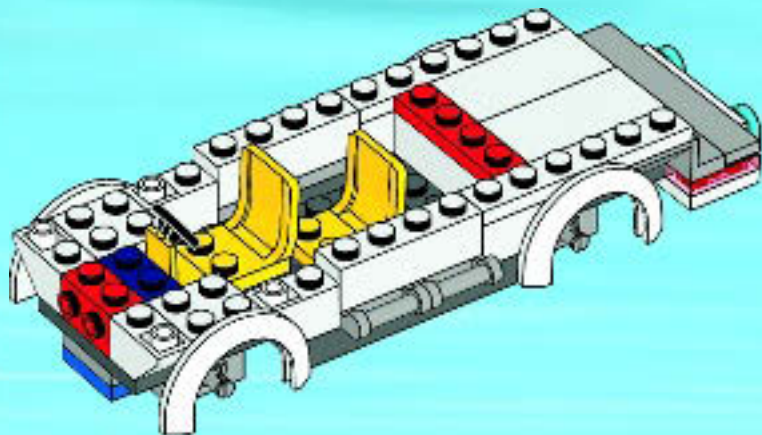



1x

1



1x

2

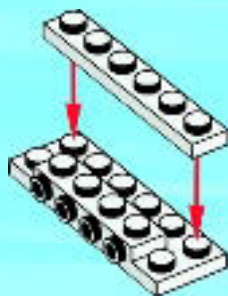



2x

3



1x



2x

4

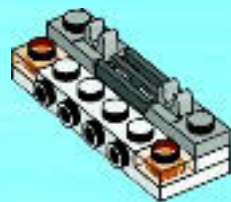



2x



1x

5

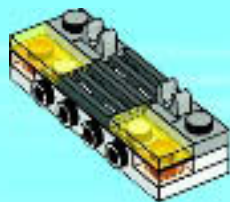

20

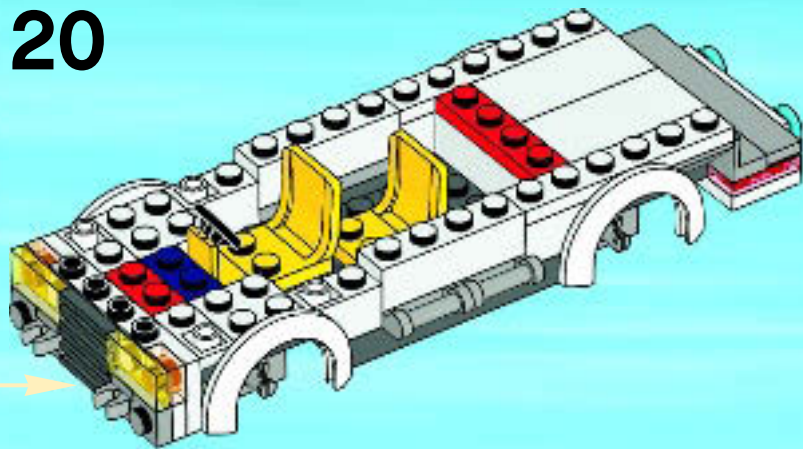



2x

21

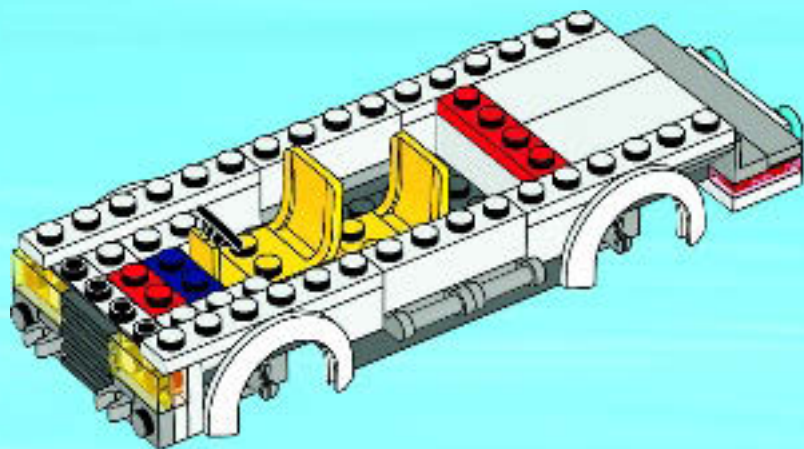



2x



1x

22

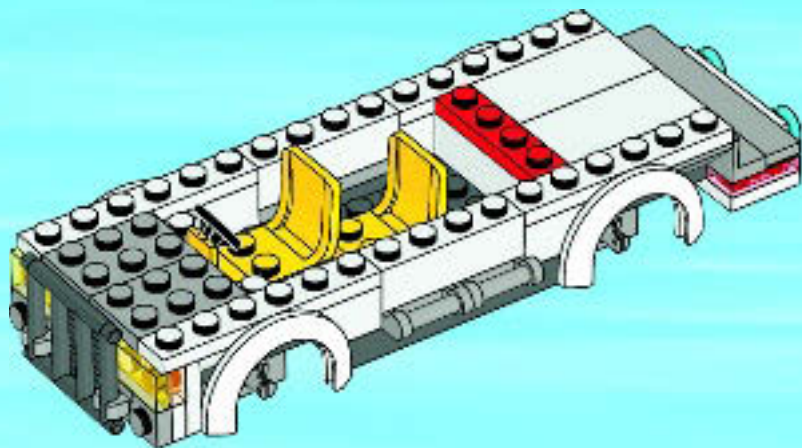

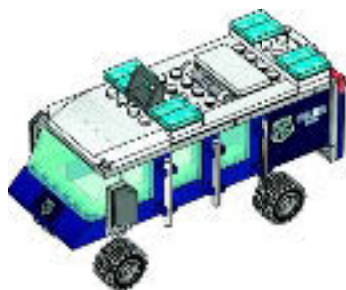

2x

23

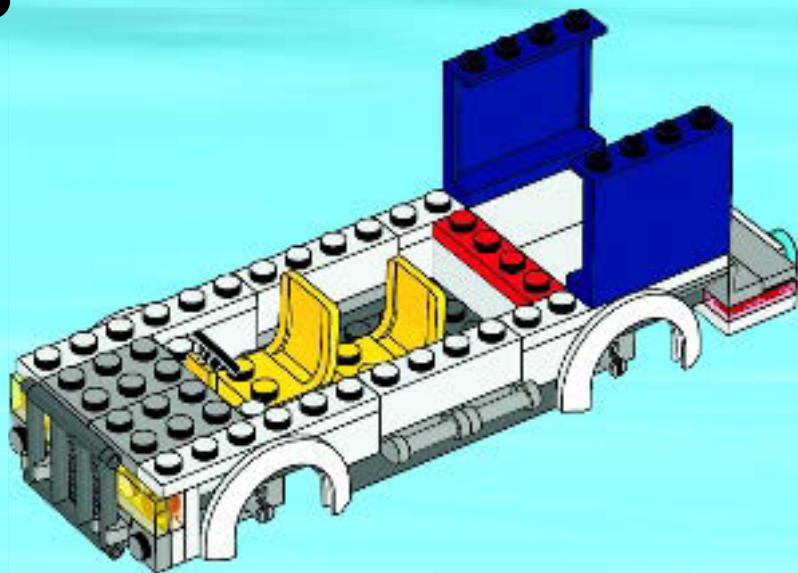



2x



2x

24

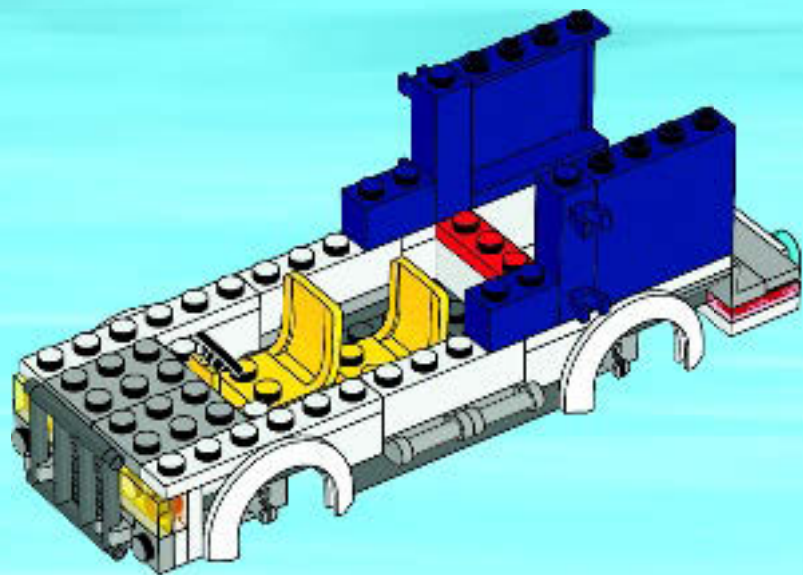



1x

25

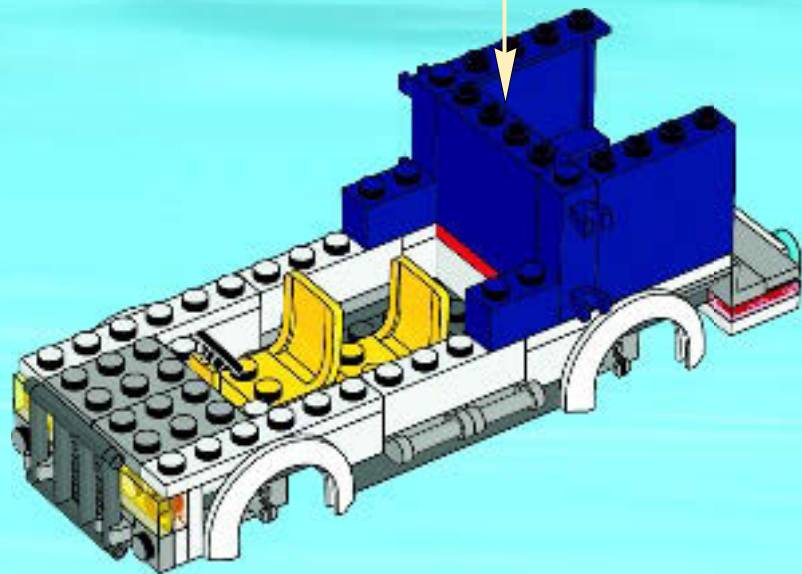
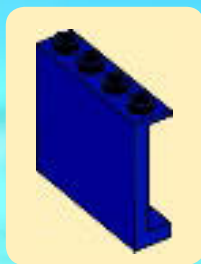



2x



2x

26

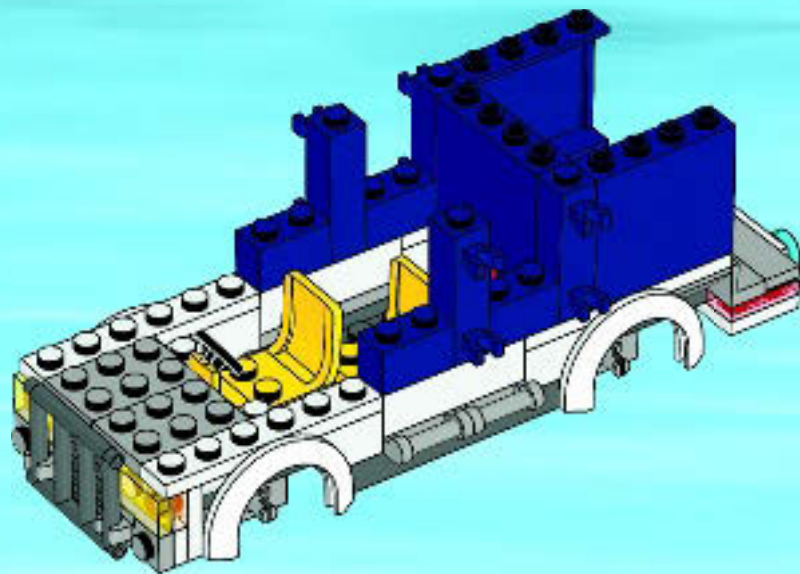



2x



2x



2x

27

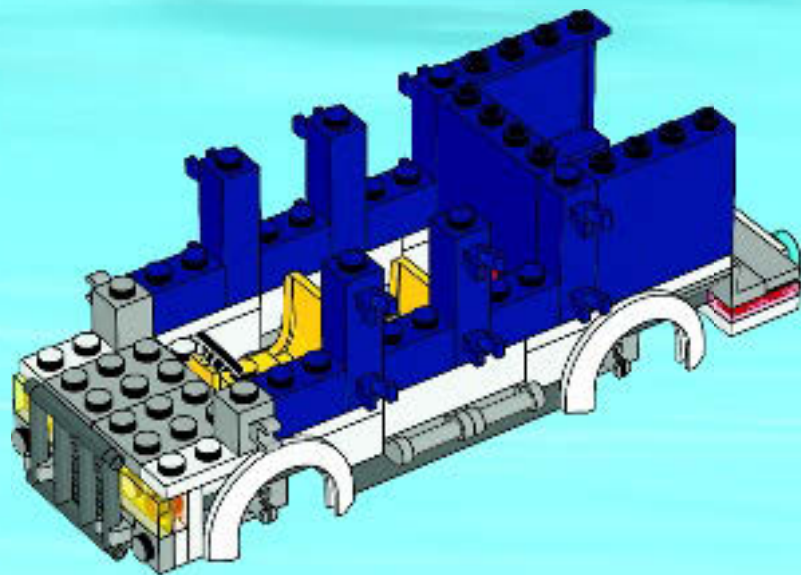



3x

28

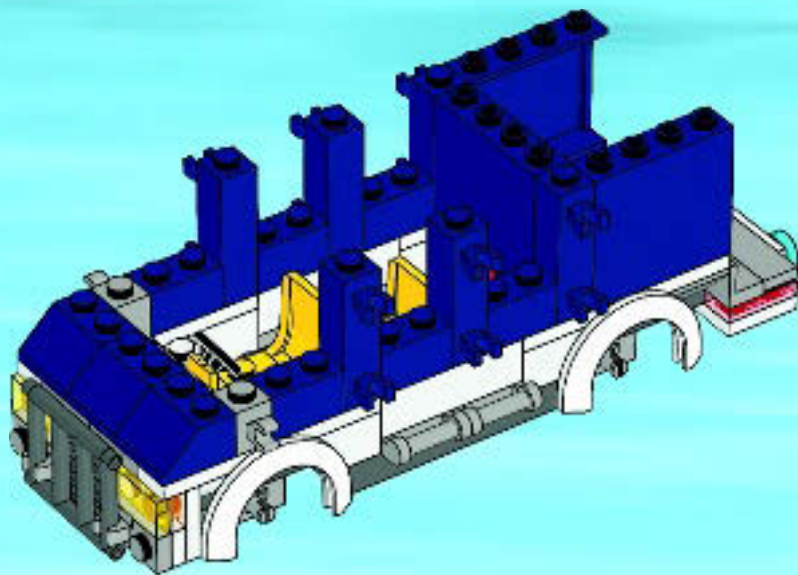



6x

29

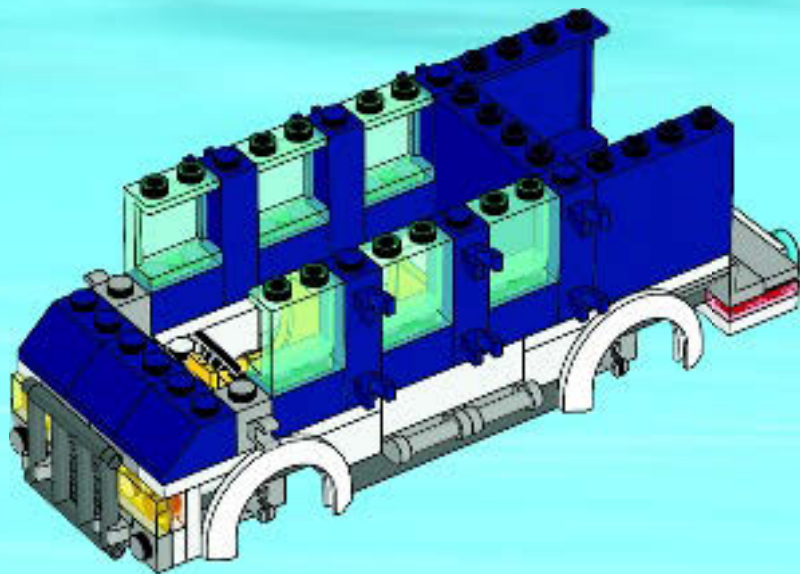



1x

30

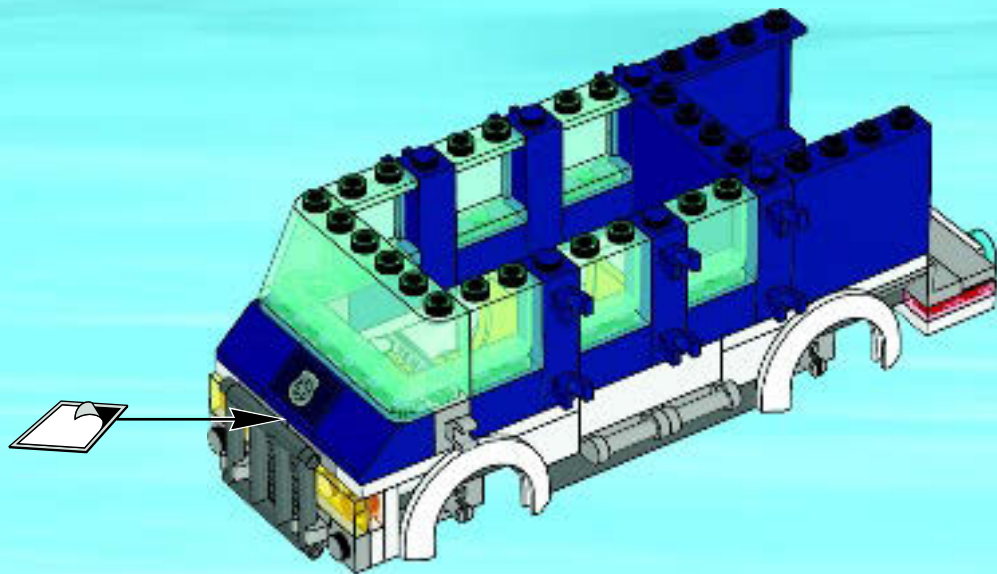



4x

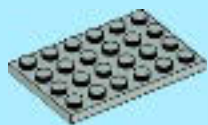

1x

31

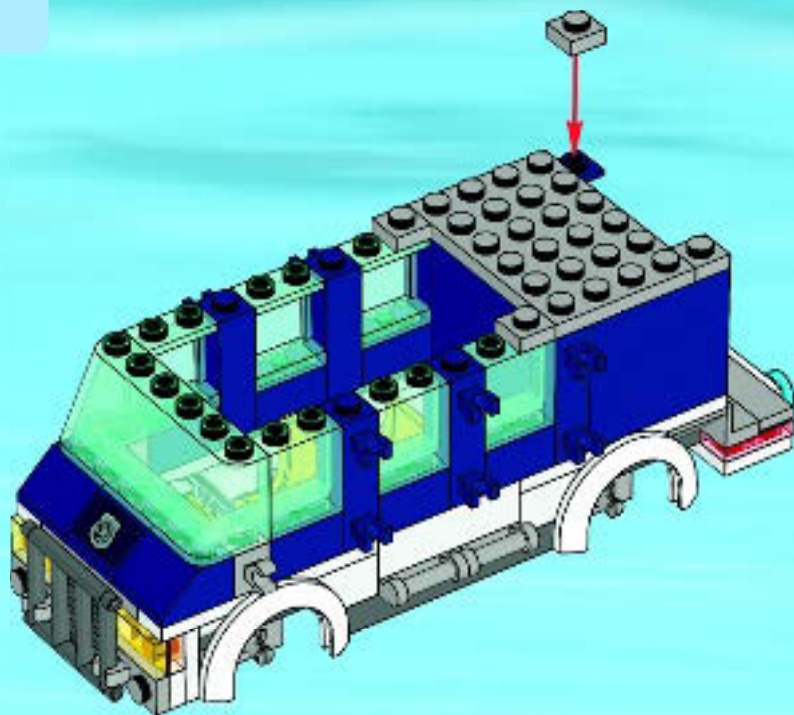

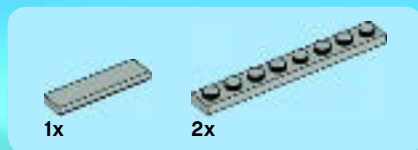

32

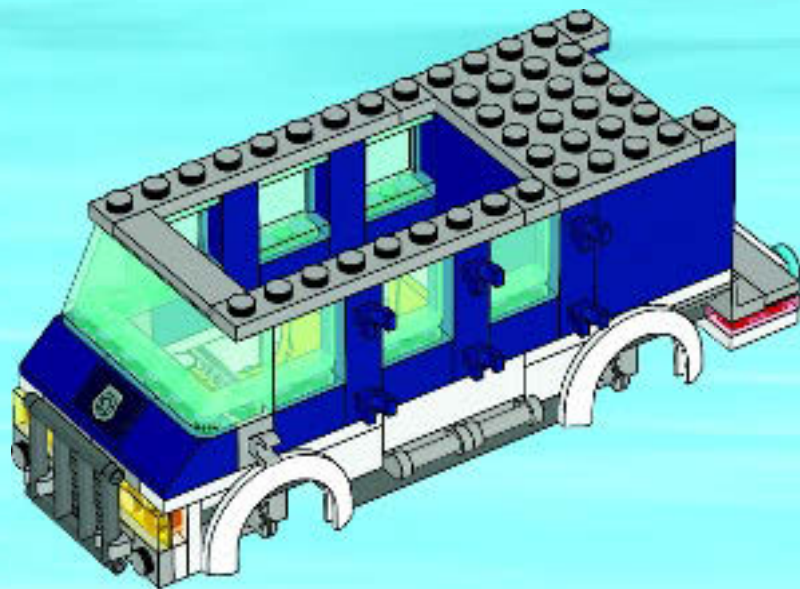



2x



2x

33

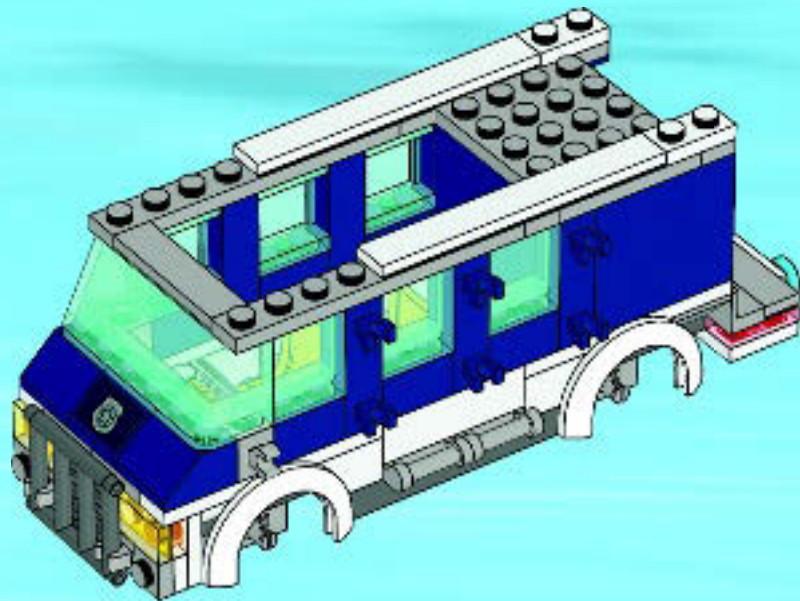



1x



2x

34

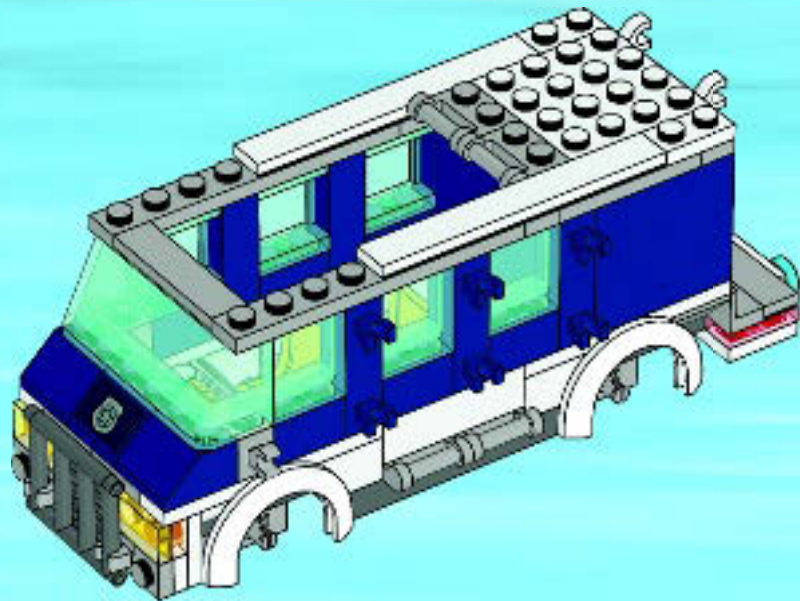

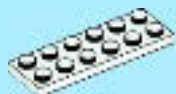

1x



1x

35

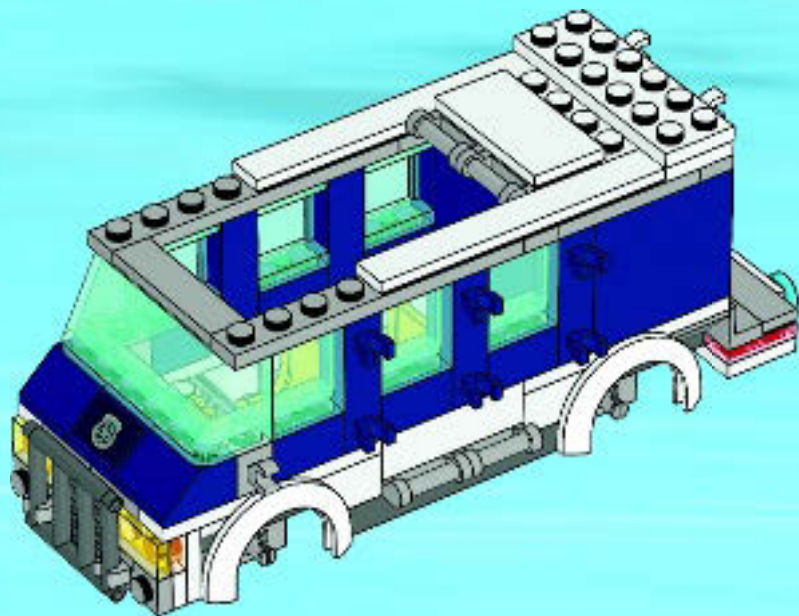



4x



1x



1x

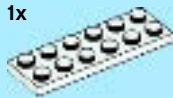

1x

36

1

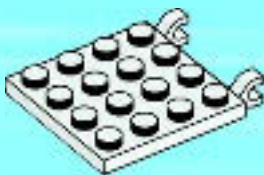

2

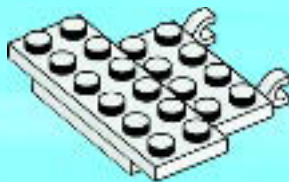

3

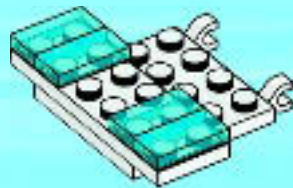

4

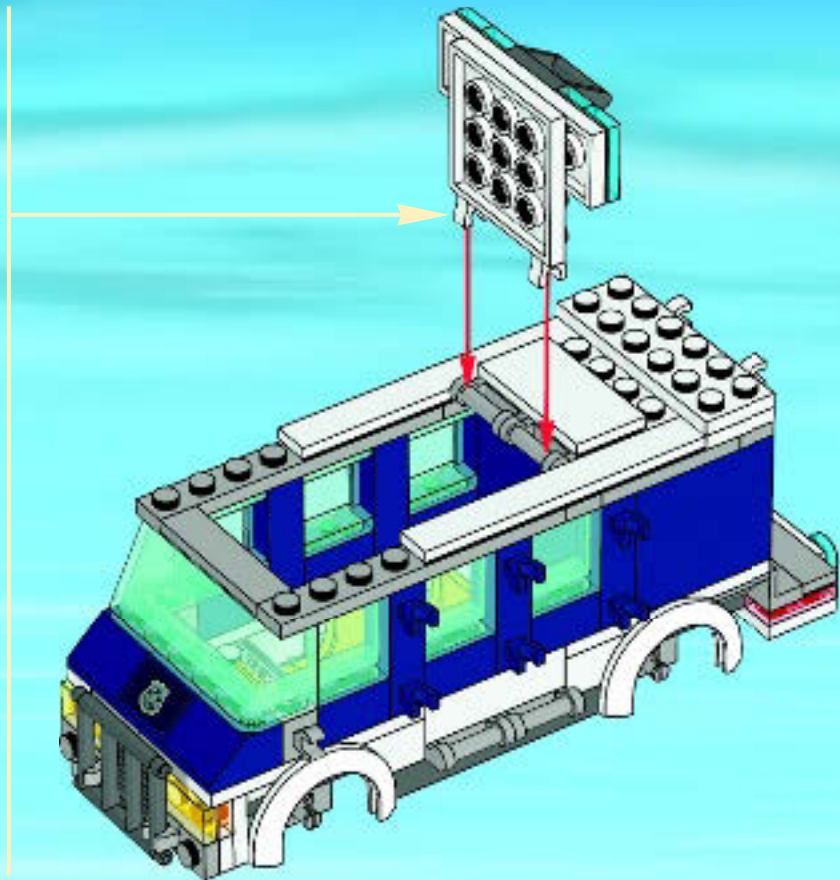



4x



1x

37

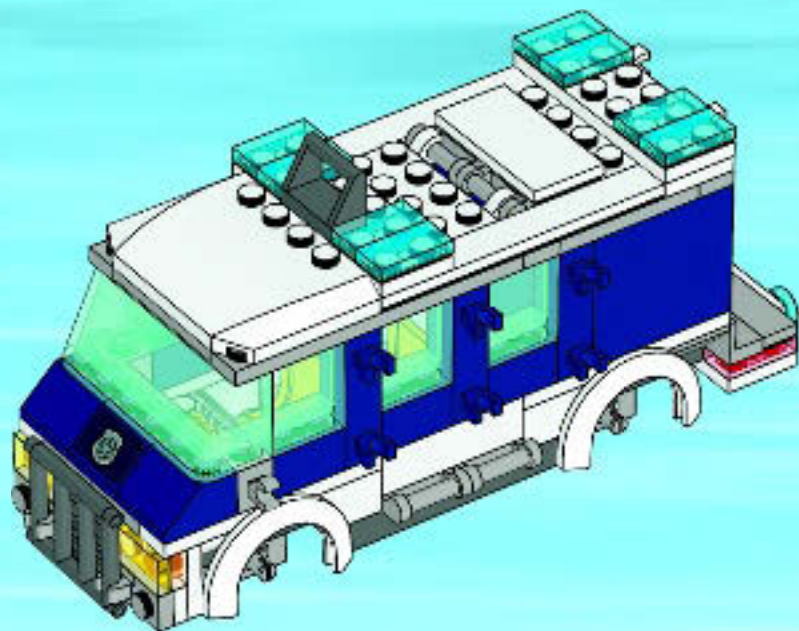



38

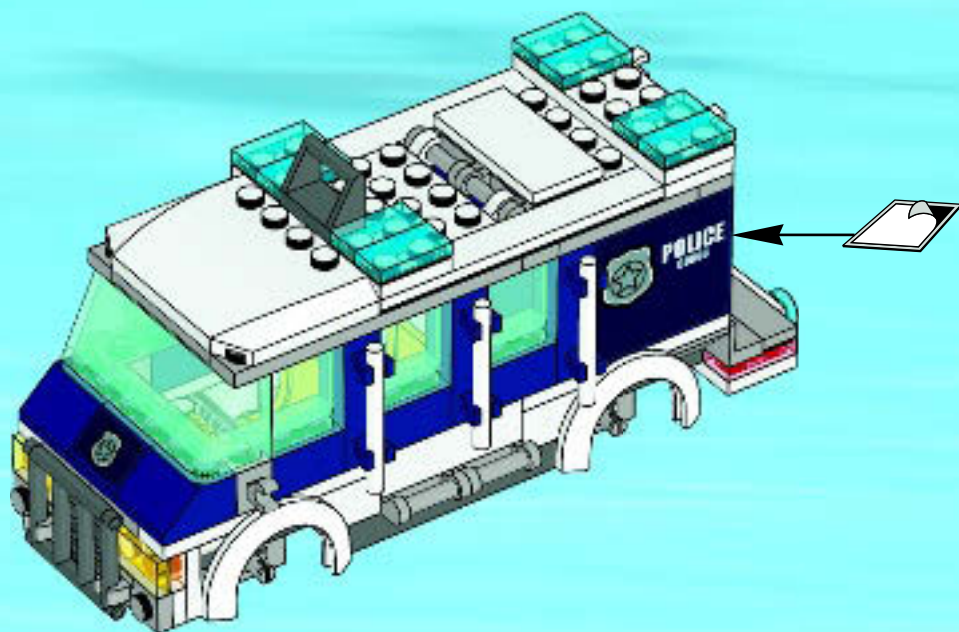



1x



1x

39

1



2

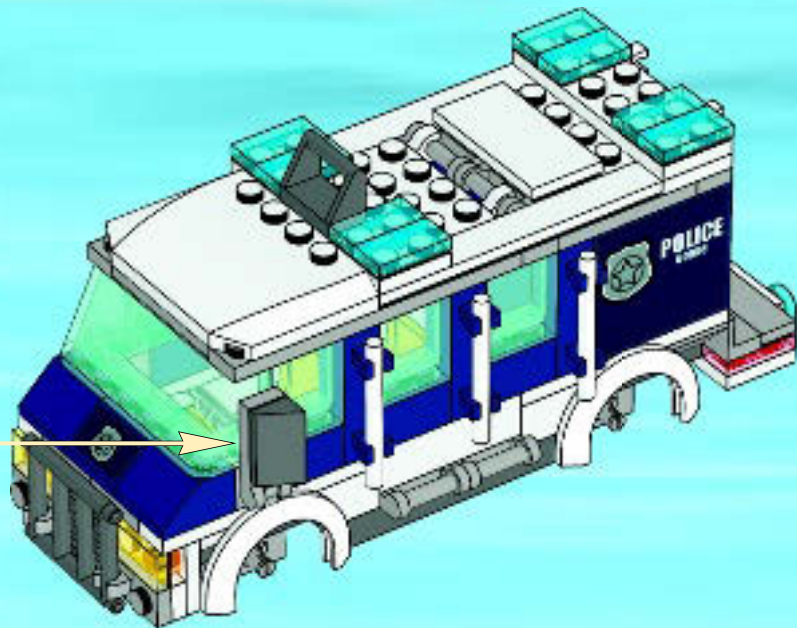



1x



1x

40



1



2

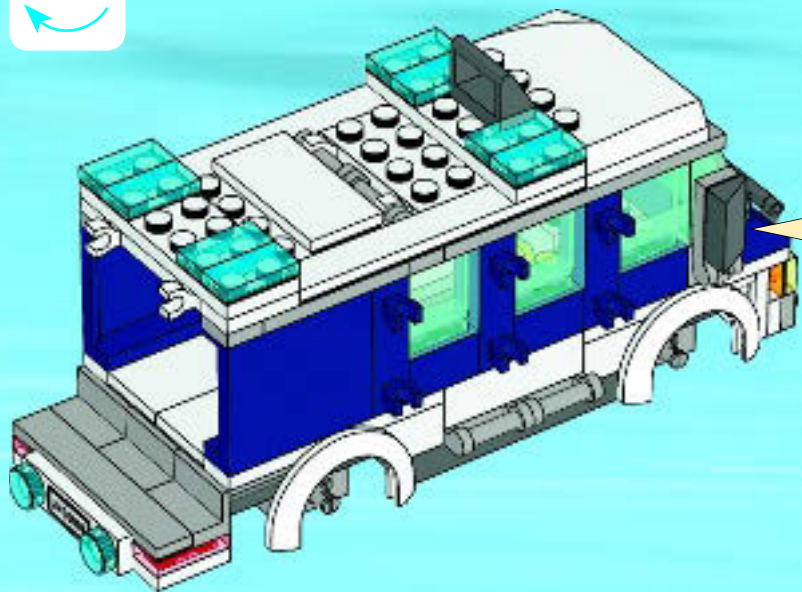



3x

41

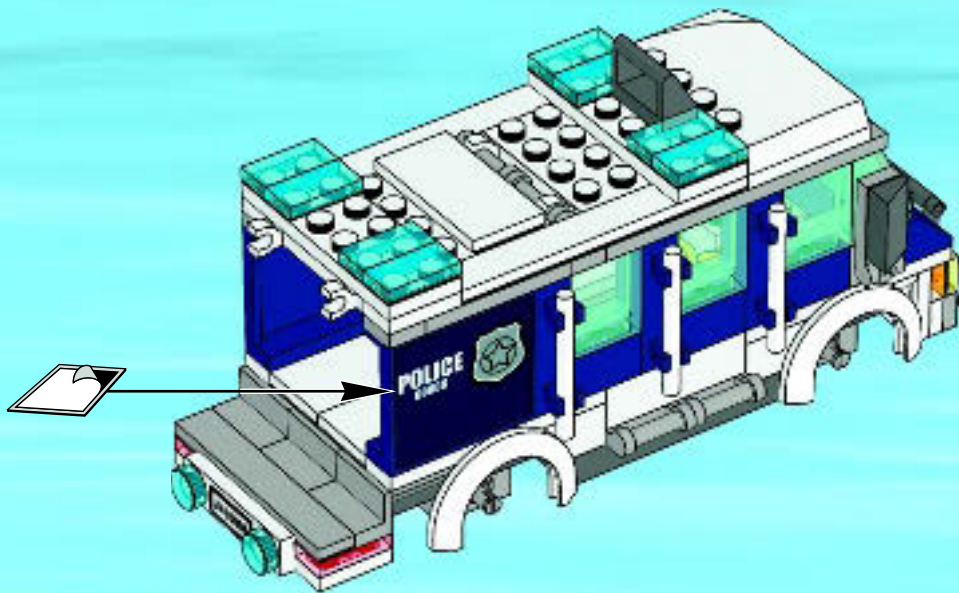

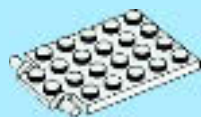
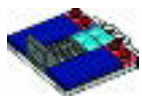

1x

1



2x



2x

2

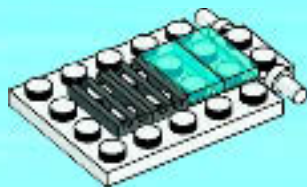



2x

3

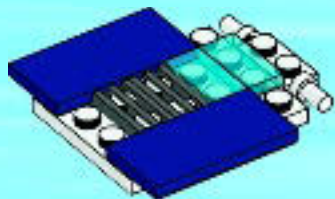

2x



2x

4





2x



1x

5

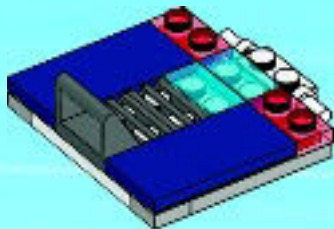

42

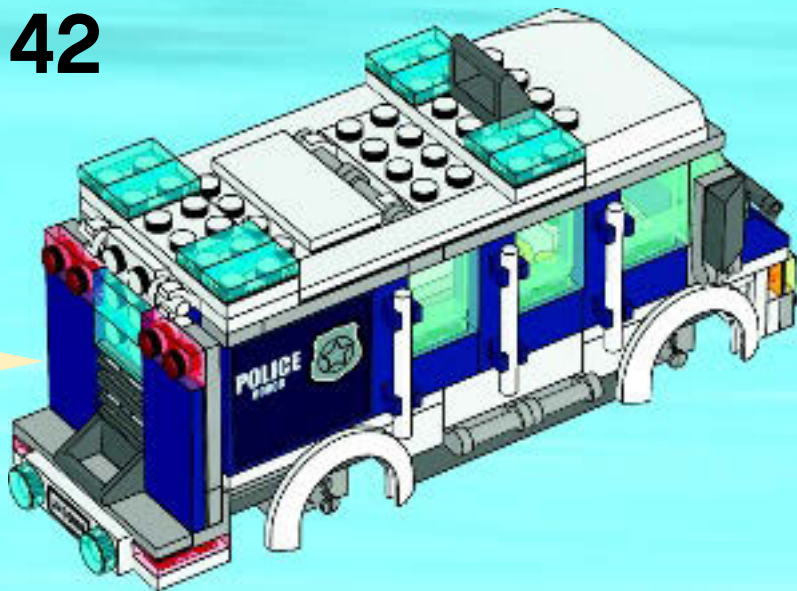



4x



4x

43

