



# Castle



70402



1



2



3



4



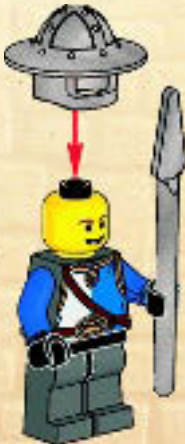

1



2



4

1



2



3



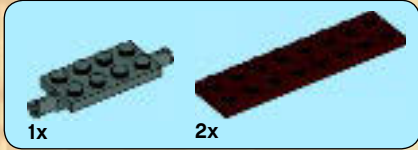

1

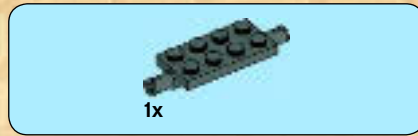
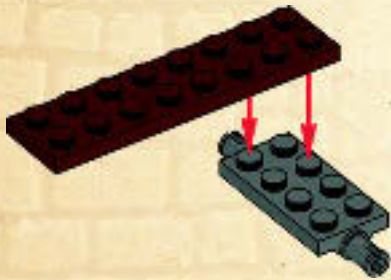

2

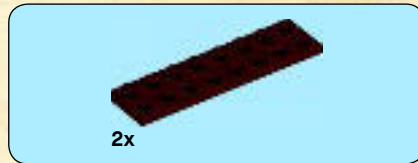
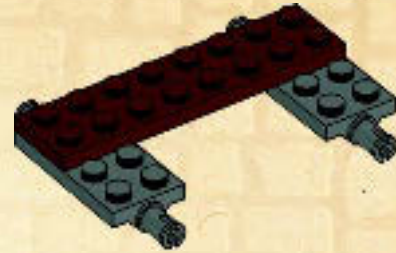

3





4x

4



2x

5

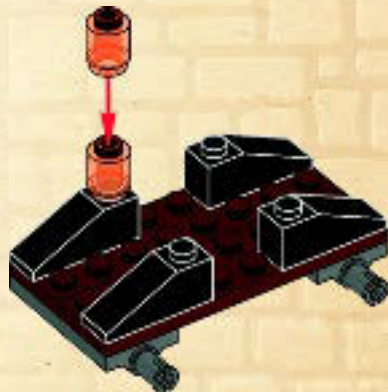

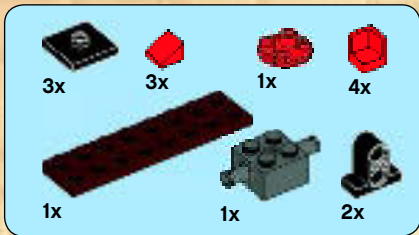

6

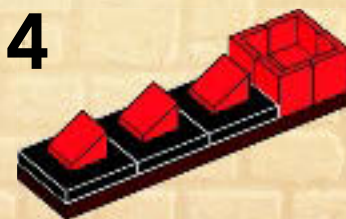
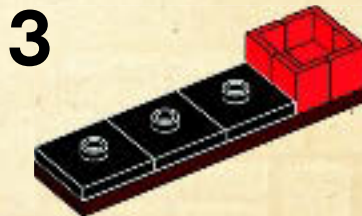
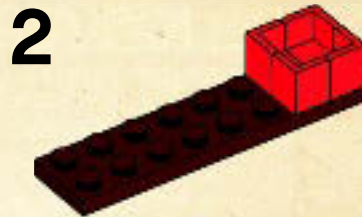
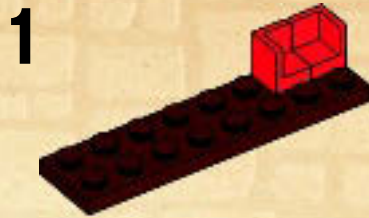

5

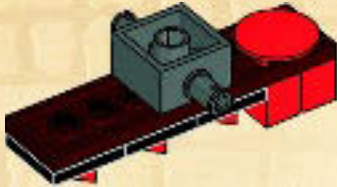

6

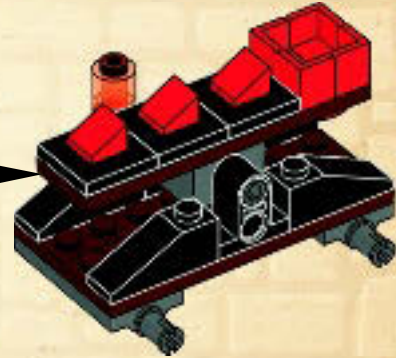
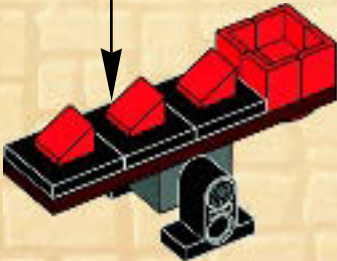



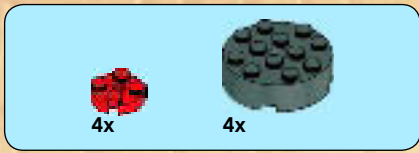

7

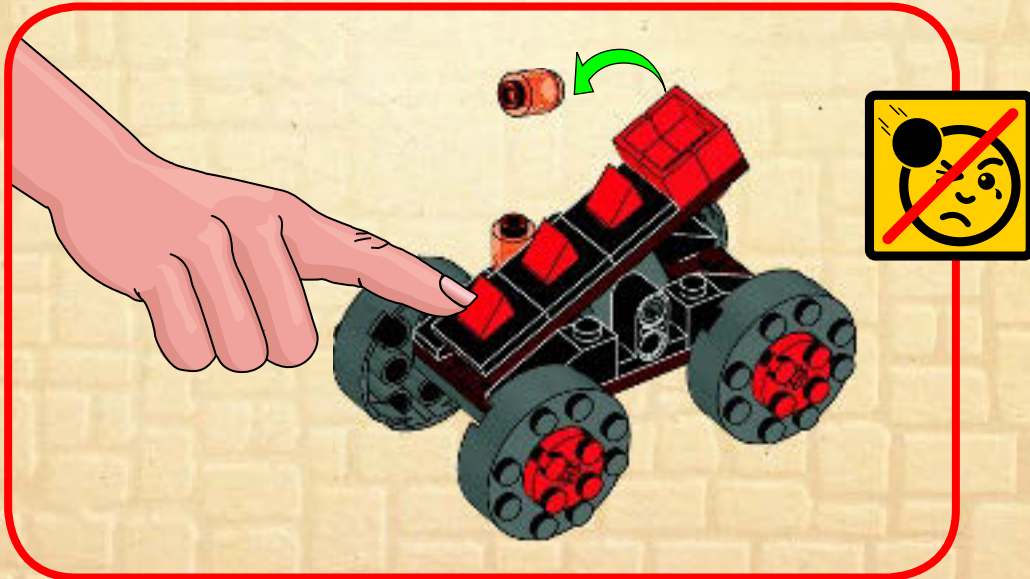
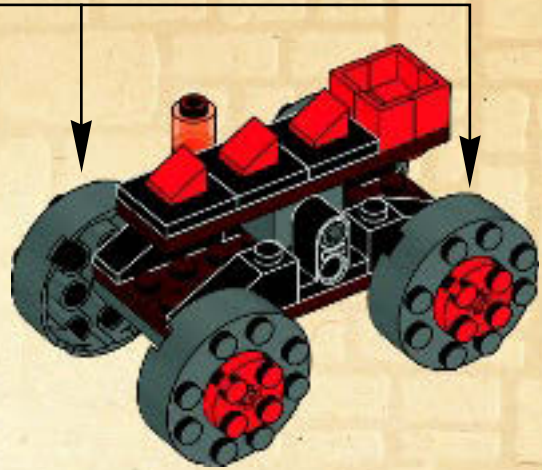
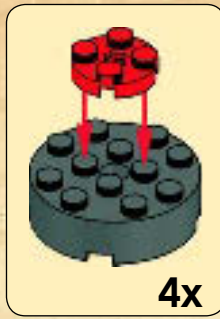

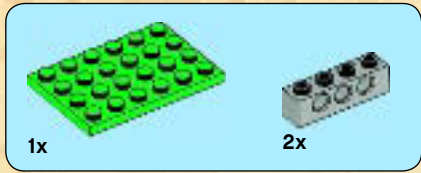
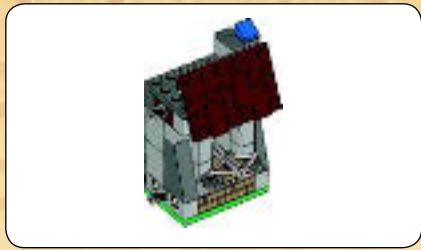

1

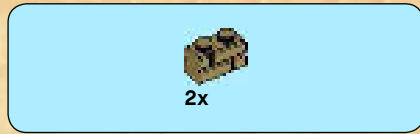
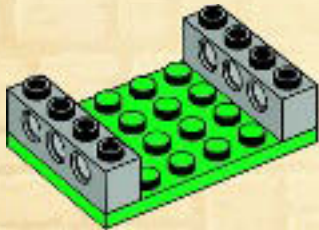

2

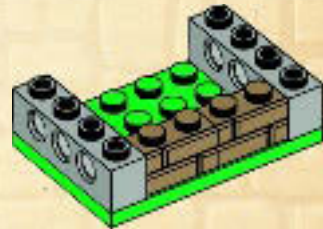



2x



2x

3

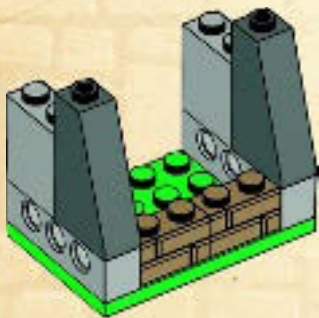

2x

4

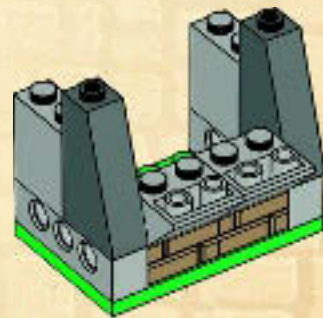



2x

5

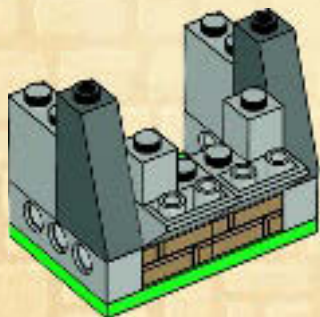

2x

6

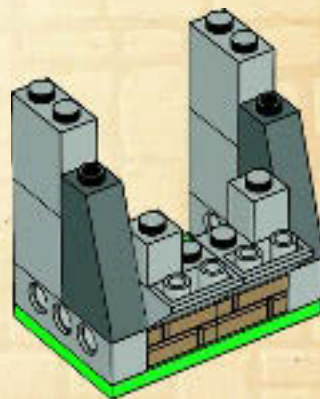



7

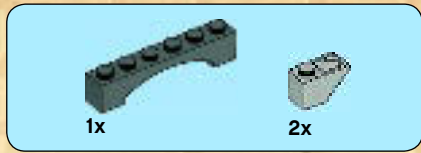
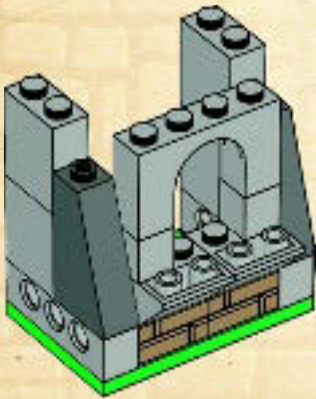

8

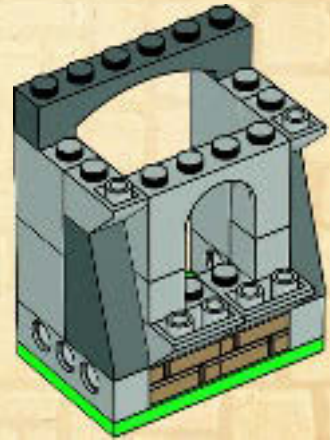



2x

9

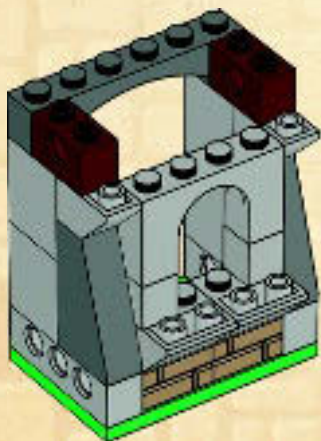

1x

10

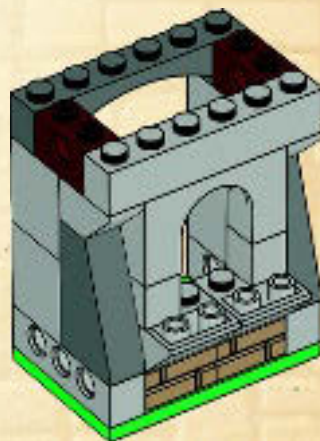

2x



1x

# 11

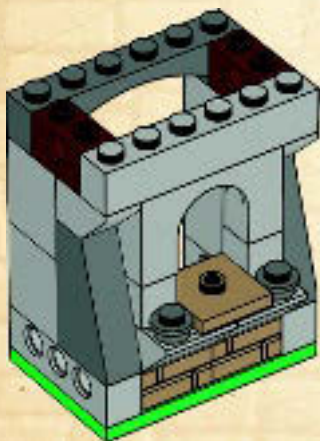

1x



1x

# 12

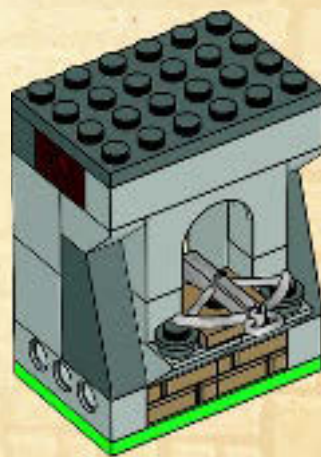



2x



1x



1x

# 13

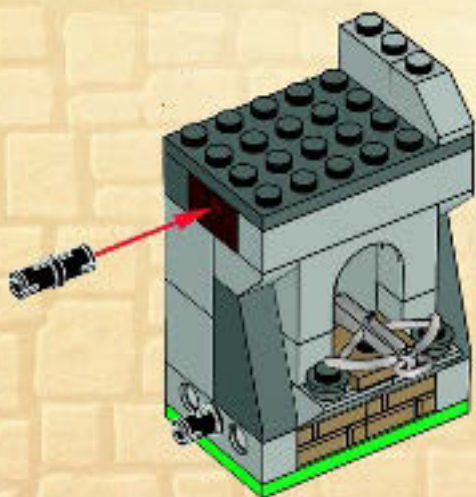

1x



1x



1x

# 14

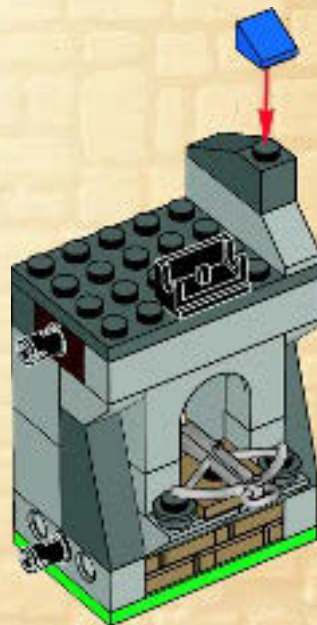



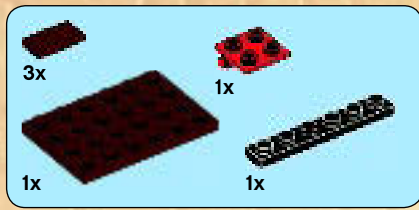

# 15

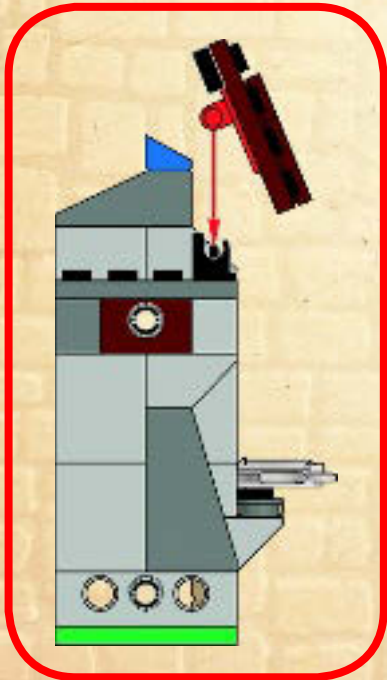

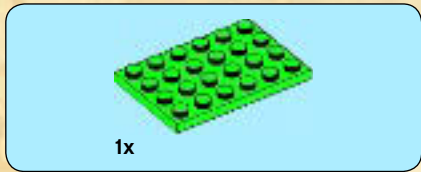
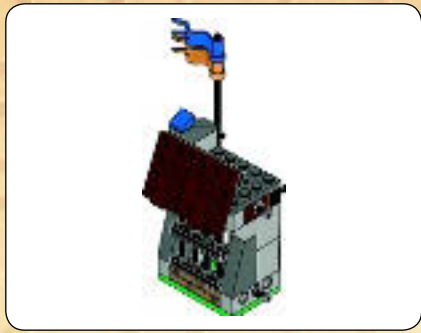

1

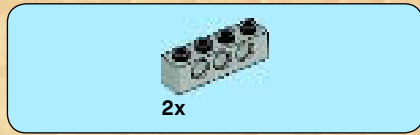

2

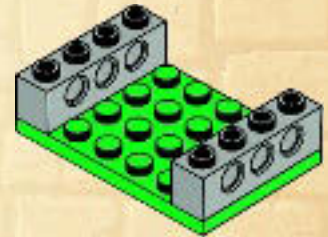

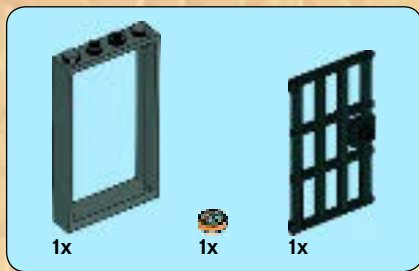

3

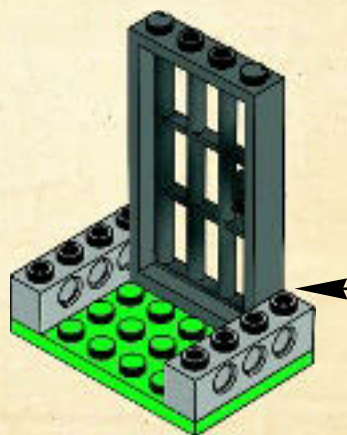
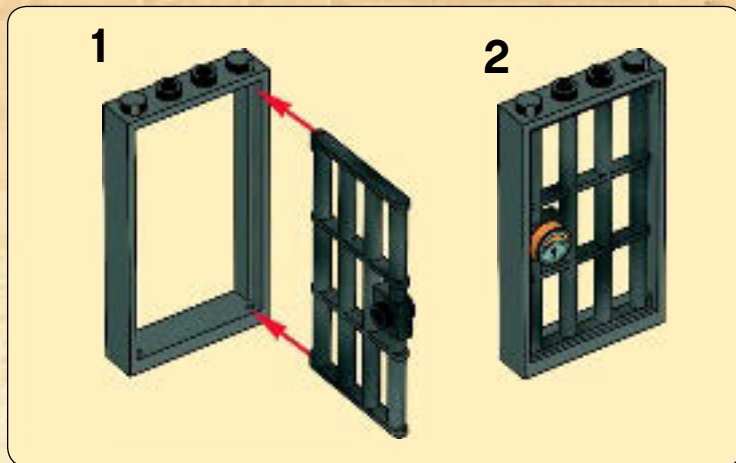





1x



2x

# 6

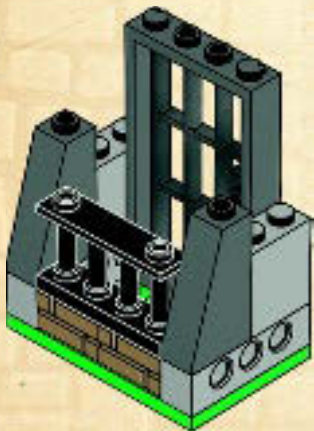

1x



2x



2x

# 7

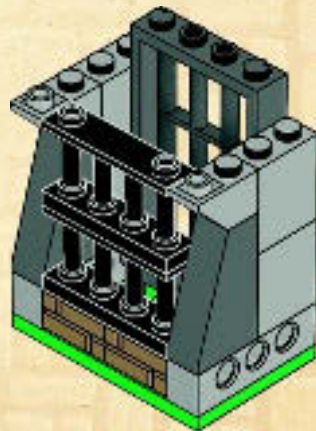



2x

8

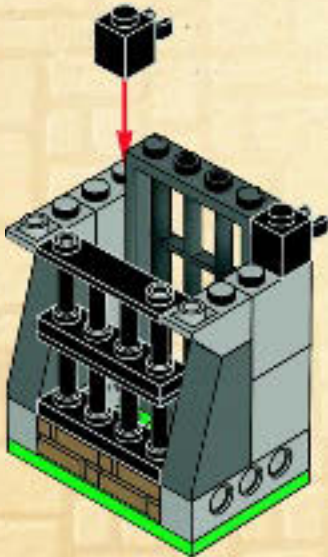

2x



1x

9

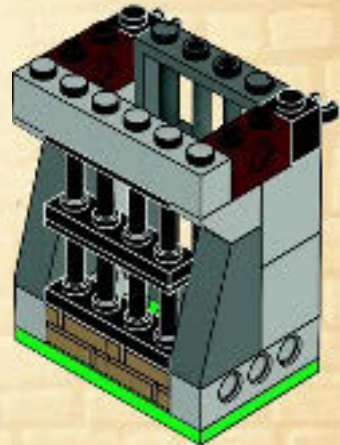



10

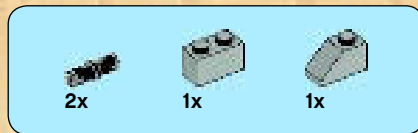
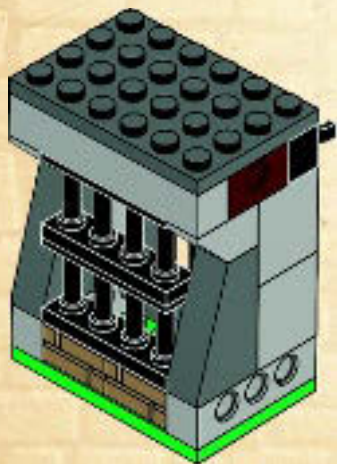

11

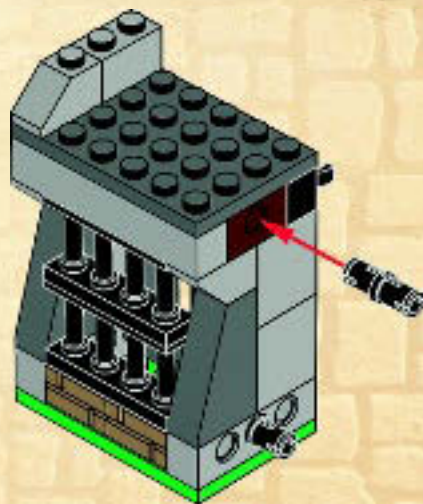



1x



1x



1x

# 12

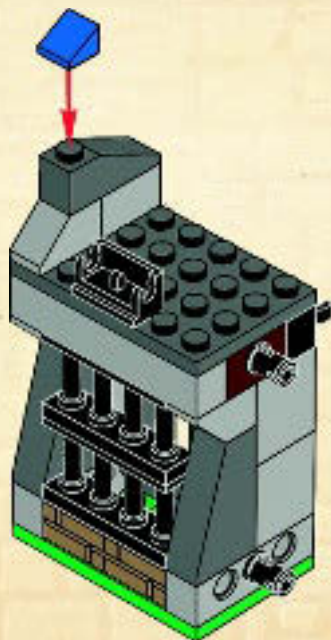





# 13

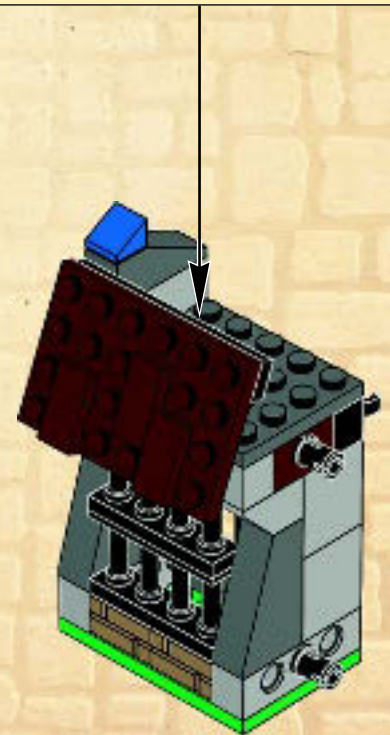
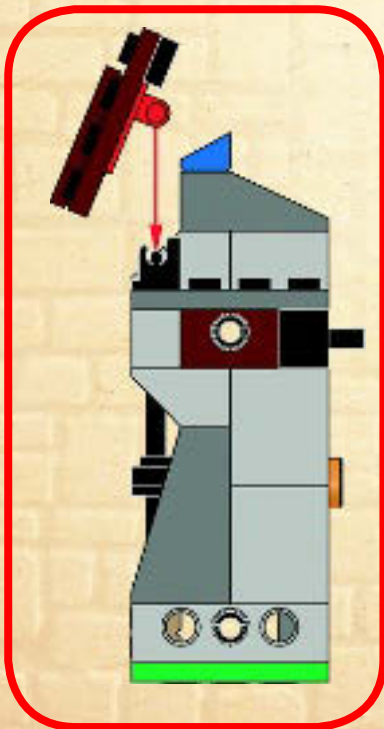
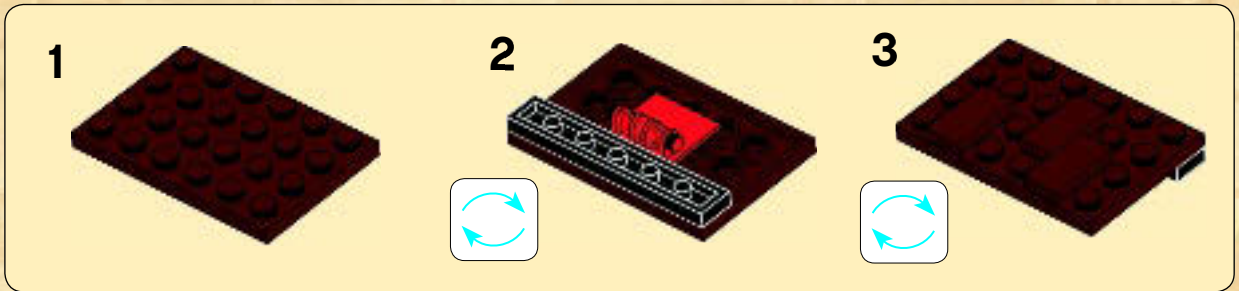

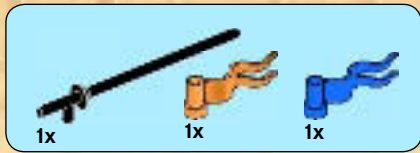

14

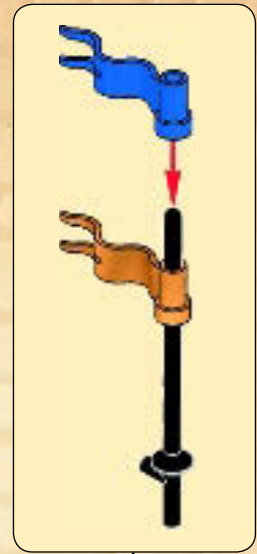
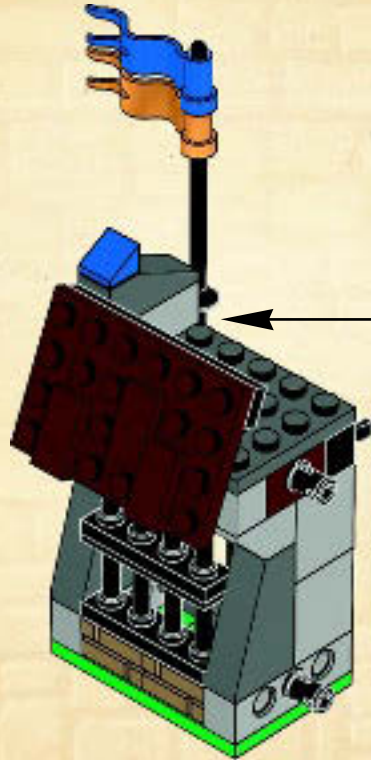

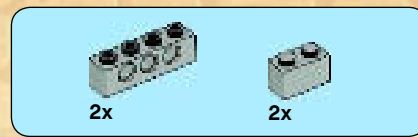
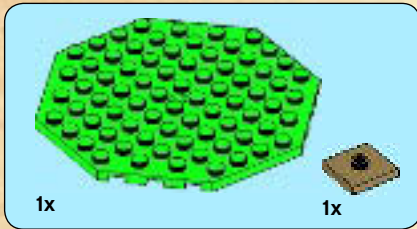
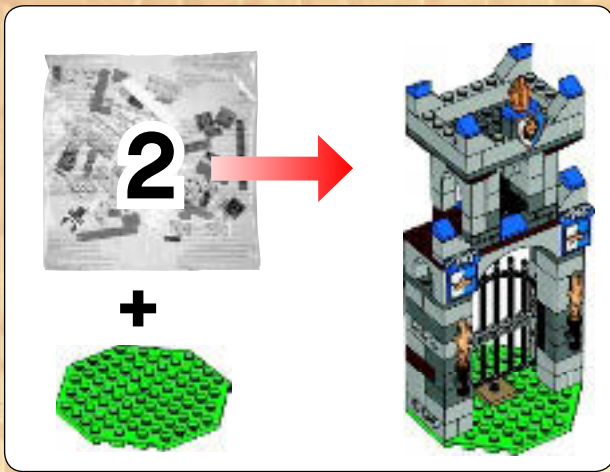



2x



2x

3

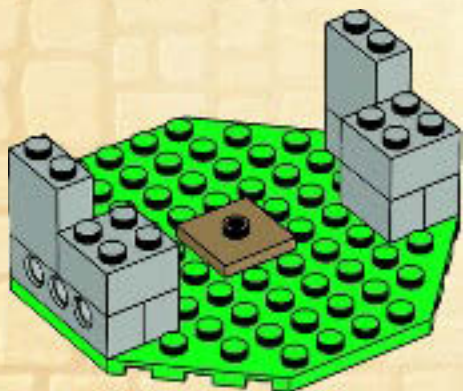

2x

4

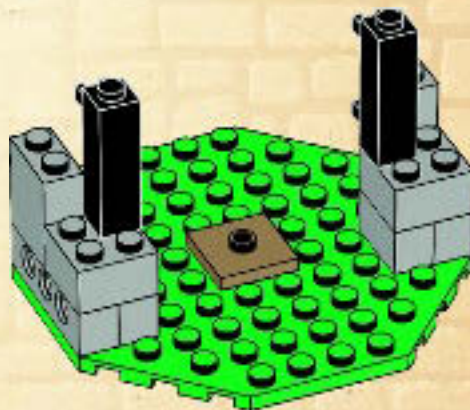



2x

5

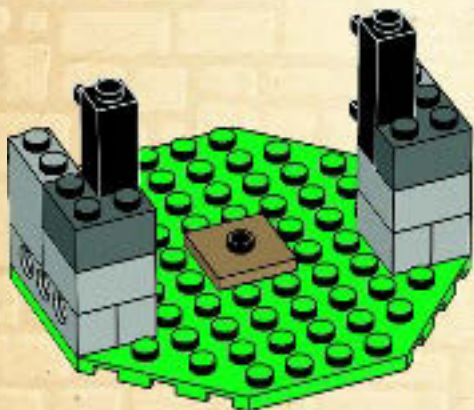

2x



2x

6

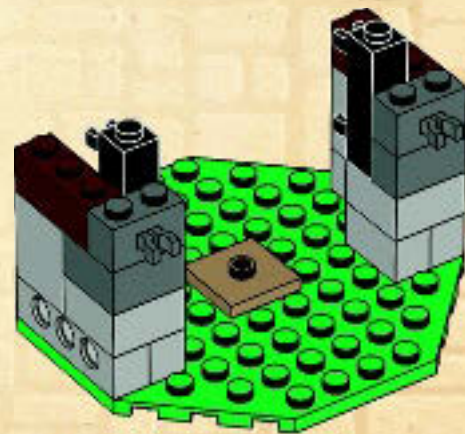



2x



2x

7

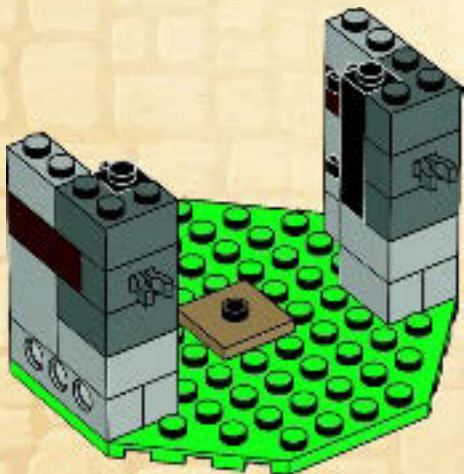

2x

8

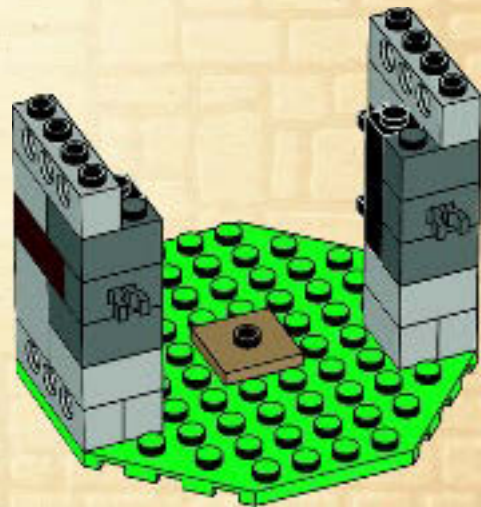



2x



2x

# 9

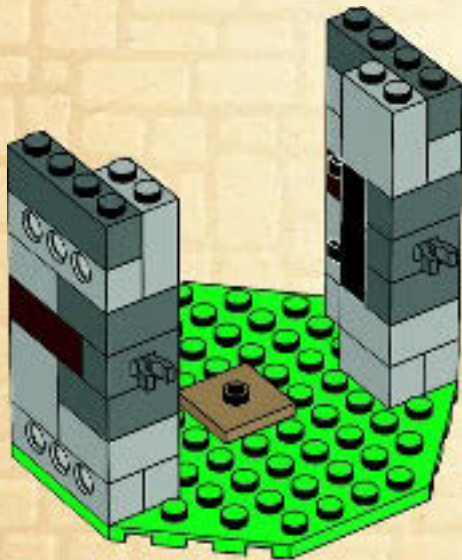

2x



2x

# 10

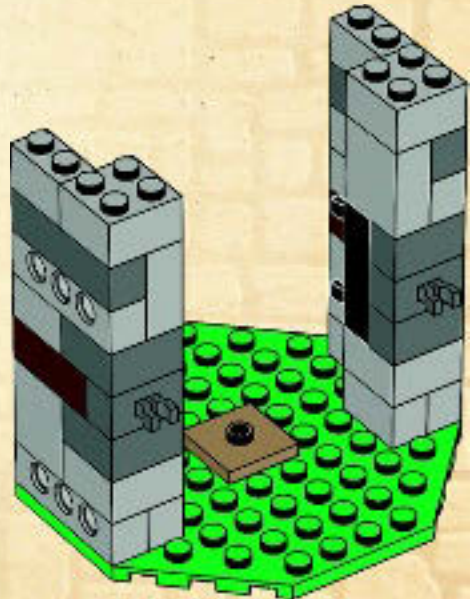



2x

# 11

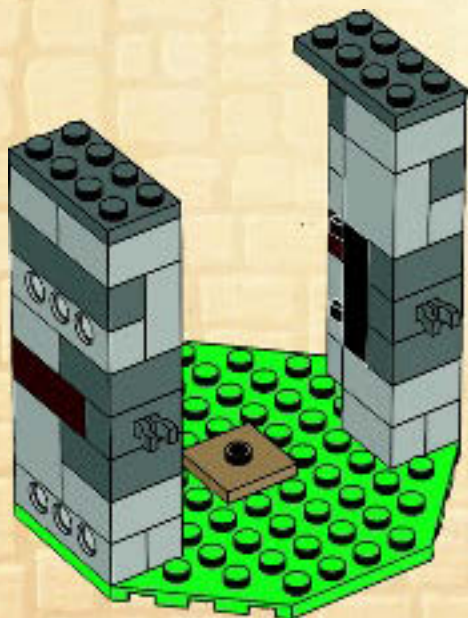

1x



2x

# 12

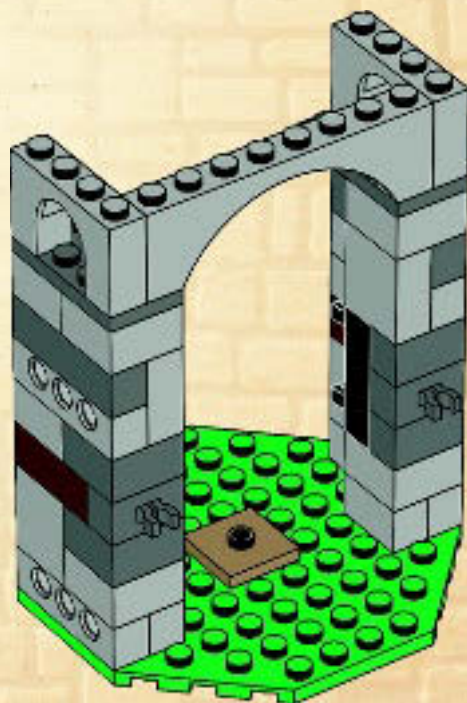





2x



2x

# 13

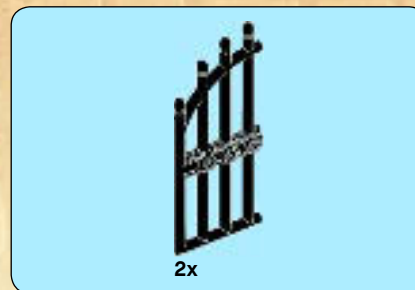
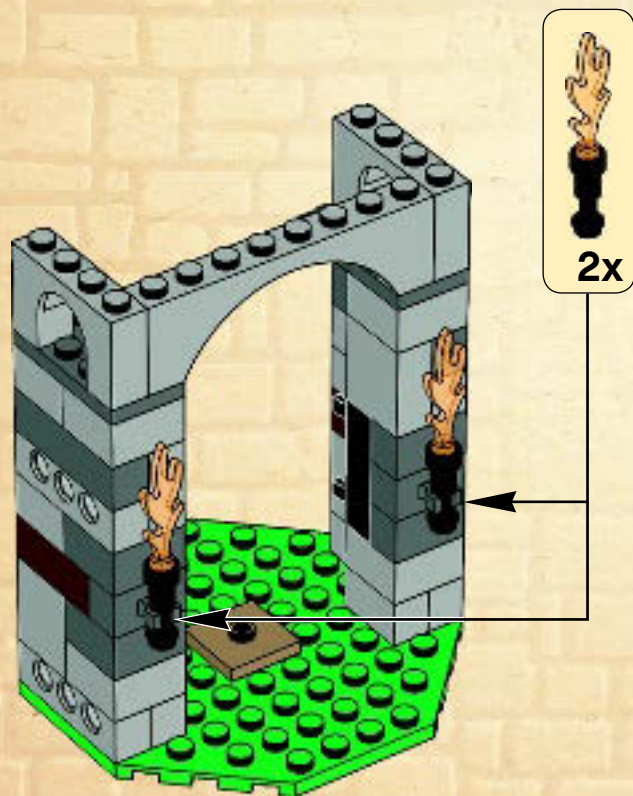

# 14

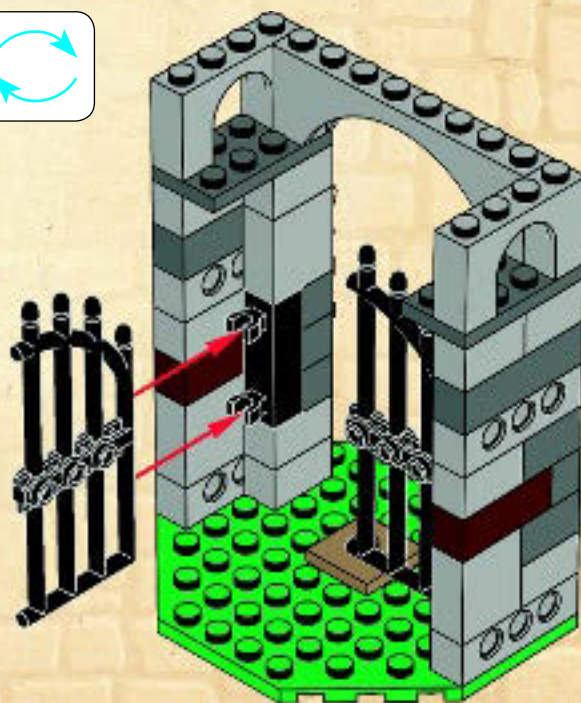
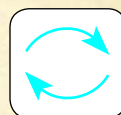



1

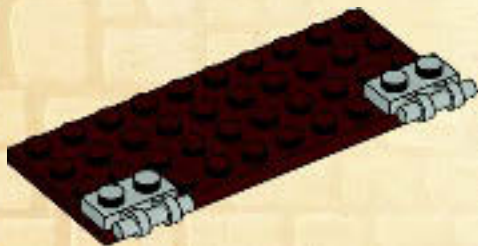

2

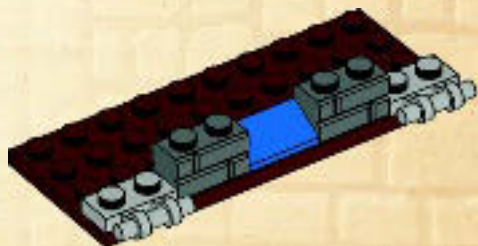



2x



2x

3

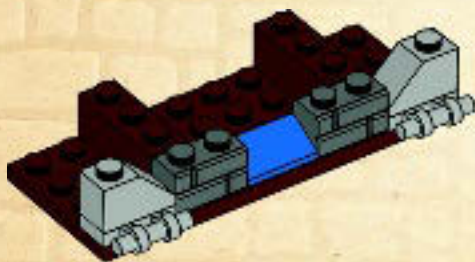

2x



2x

4

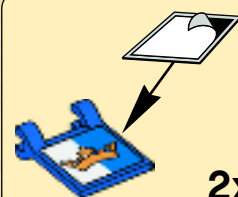
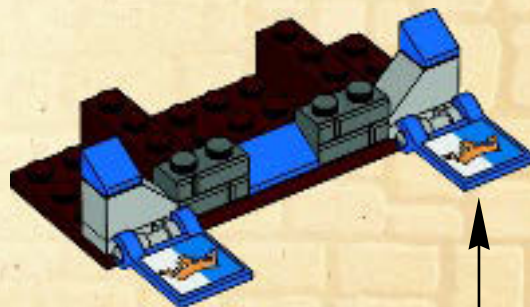

2x

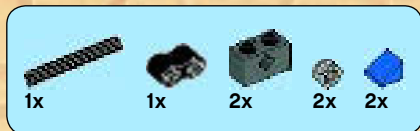

5

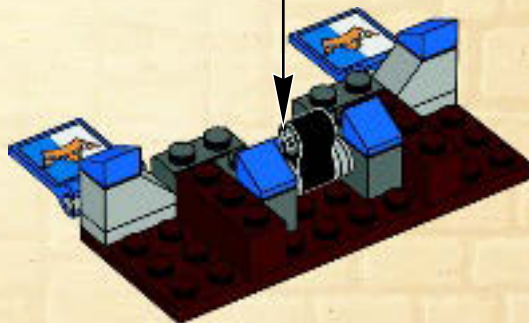
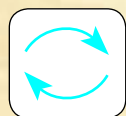
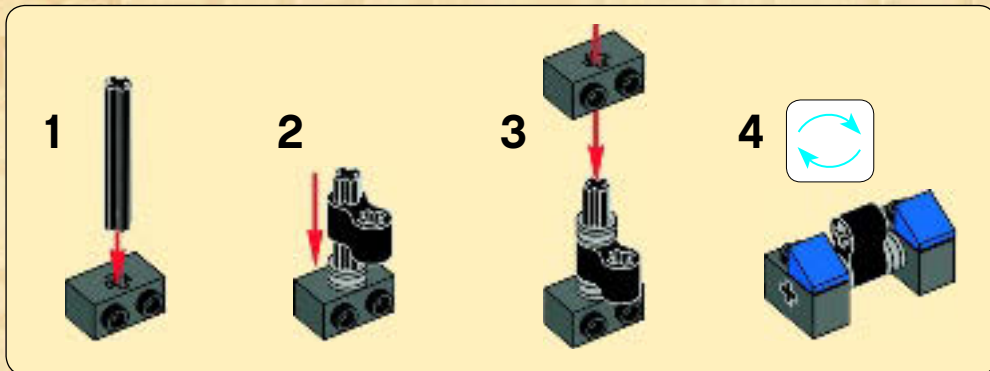



3x

6

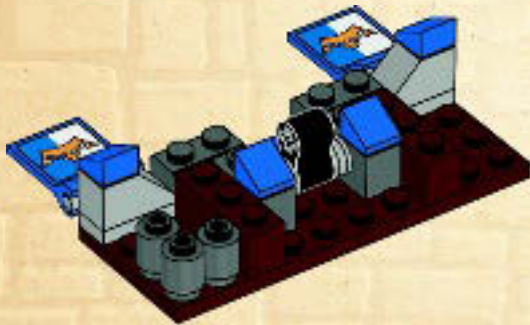

4x

7

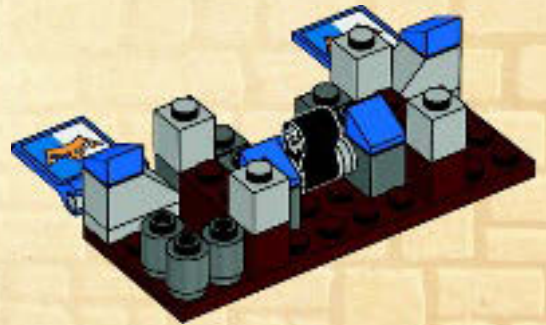



8

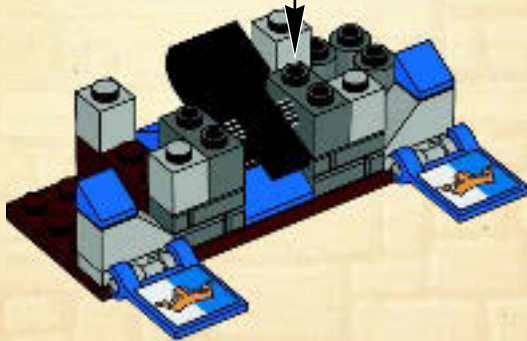
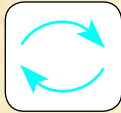
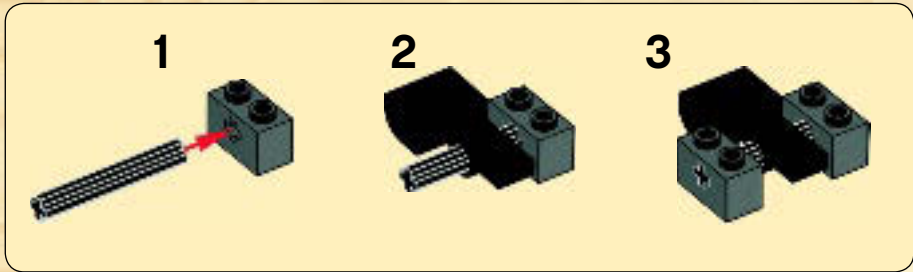



2x

9

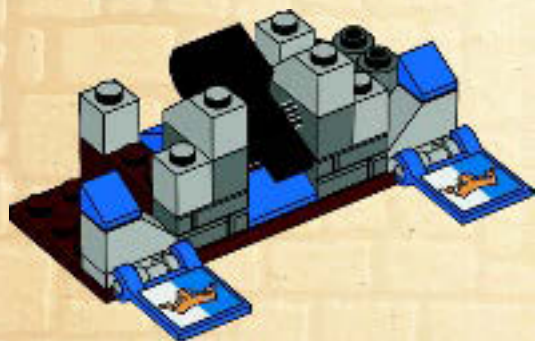

2x

10

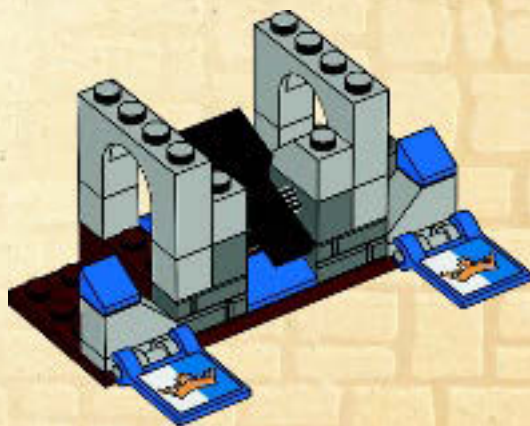



1x

11

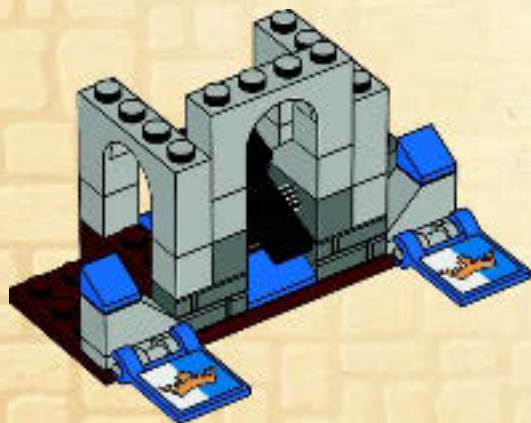

4x

12

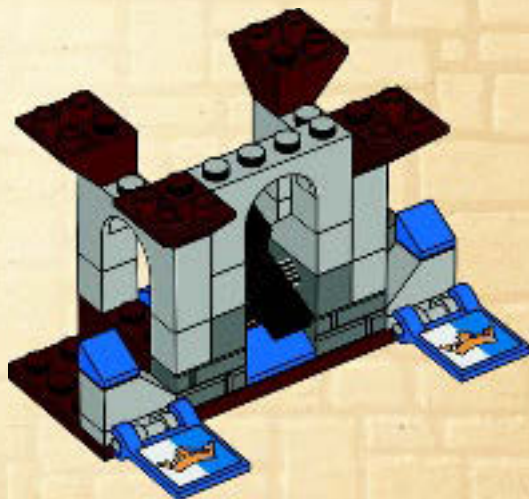





2x

13

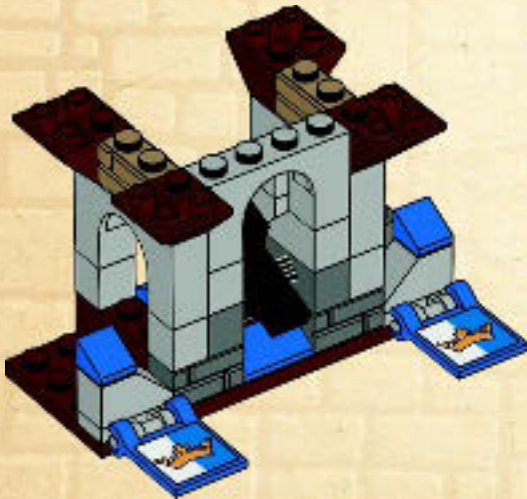

2x

14

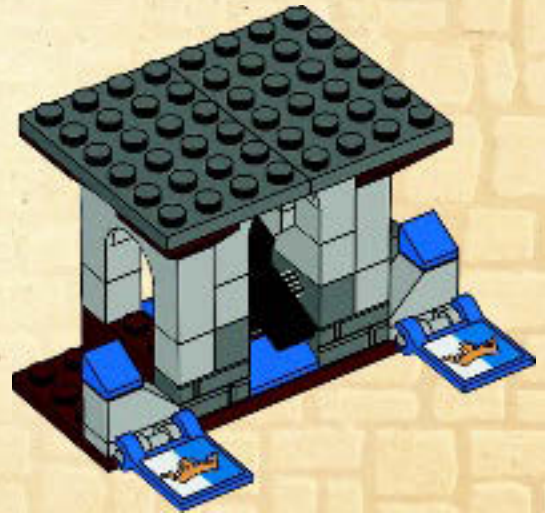



4x

15

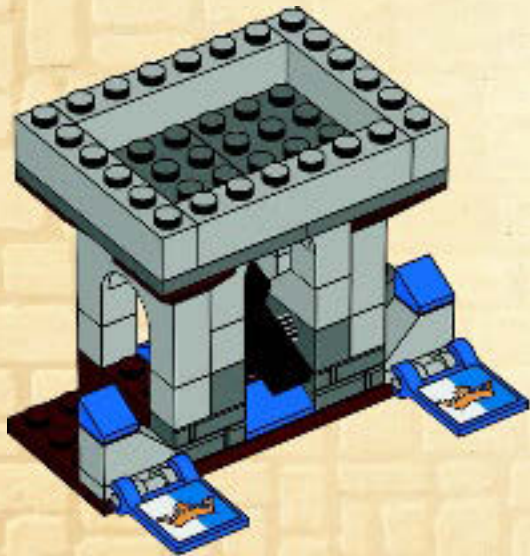

1x



4x

16

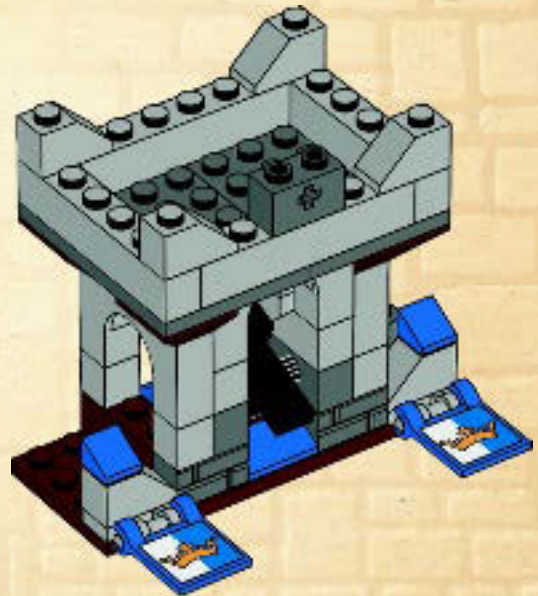



1x



4x

17

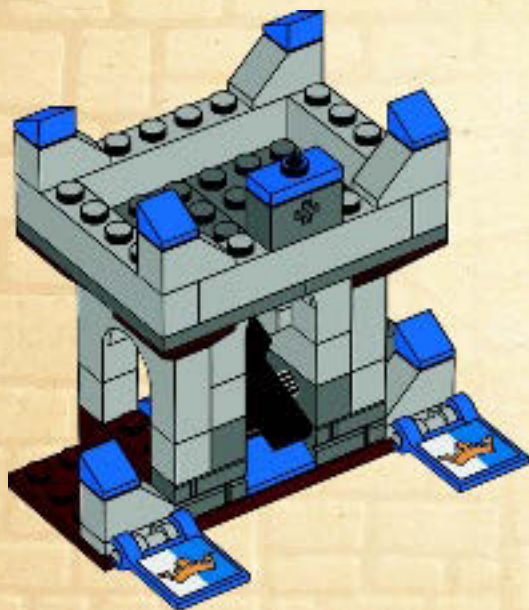

1x



1x

18

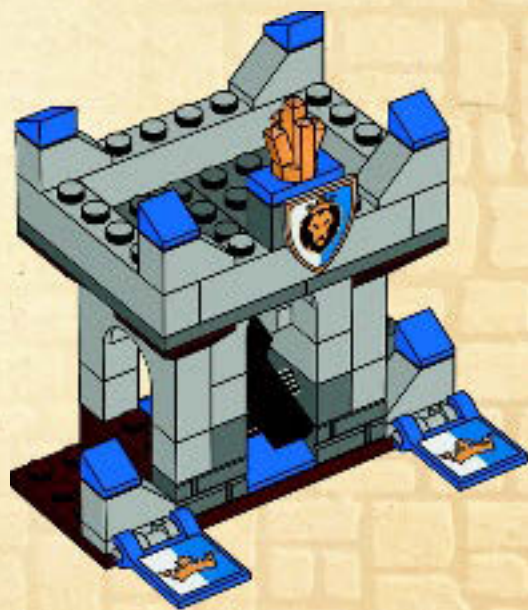

15

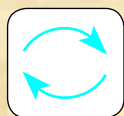
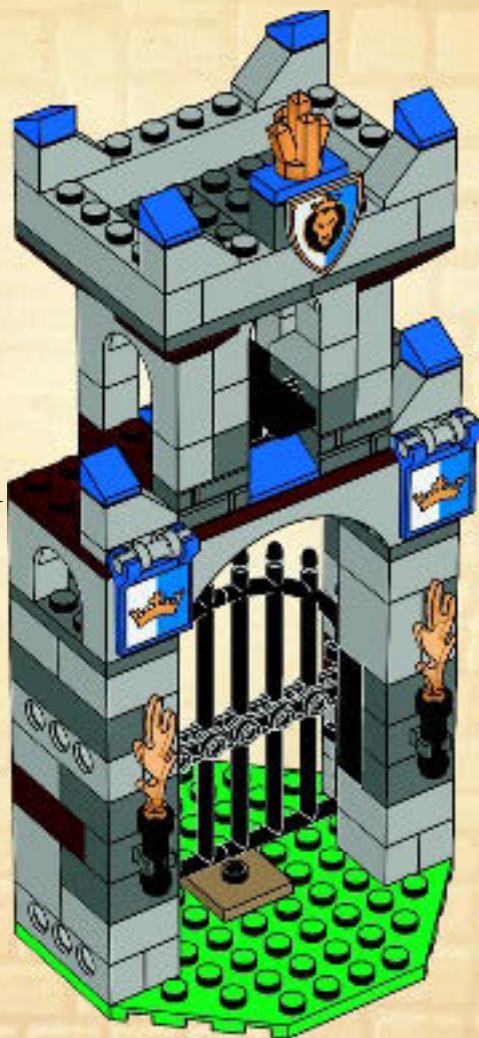

16

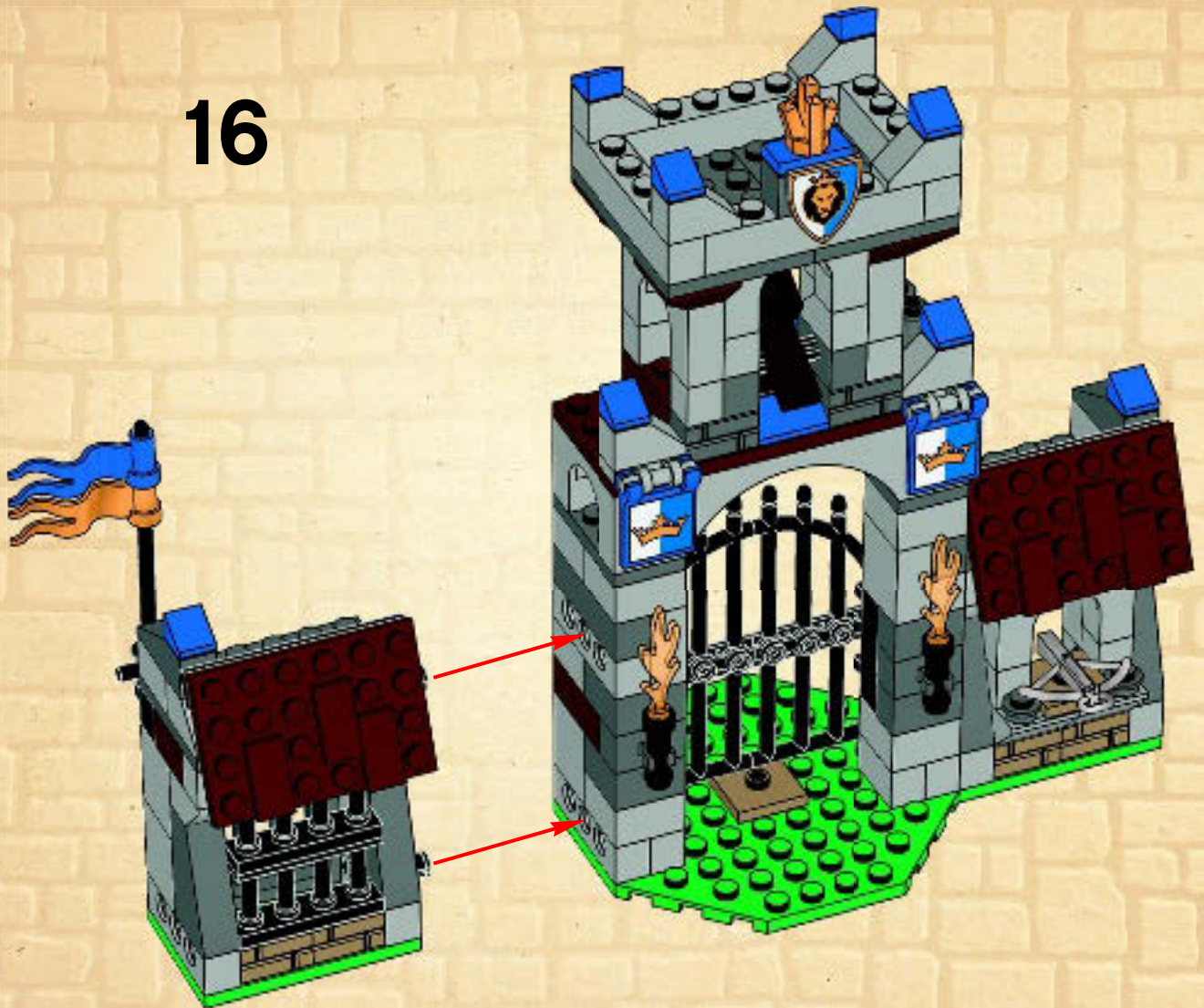



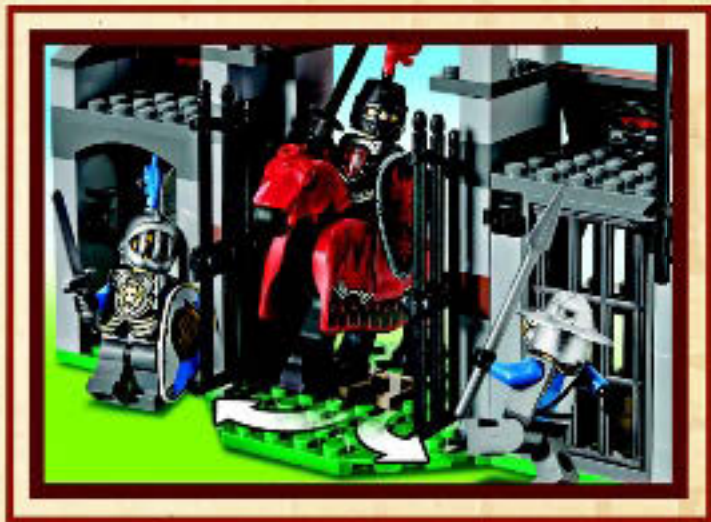



70404



70402



70400



70403



70401





**LEGO.com/castle**



# club™

## Free\*! Gratuit!

\* Paid subscription in Australia and New Zealand.  
Abonnement payant en Australie et Nouvelle-Zélande



© 2013 The LEGO Group.



# LEGO.com/club

- |                |               |               |               |                |               |               |               |
|----------------|---------------|---------------|---------------|----------------|---------------|---------------|---------------|
| 3x<br>4504379  | 1x<br>6038472 | 1x<br>6039766 |               | 6x<br>4211389  | 2x<br>4211573 |               | 1x<br>4516816 |
| 4x<br>403221   | 1x<br>6038473 | 1x<br>9339    | 1x<br>4583684 | 12x<br>4211564 | 4x<br>4211109 | 4x<br>4211115 | 1x<br>4506721 |
| 1x<br>4278275  | 2x<br>4578032 | 1x<br>6039761 | 2x<br>4261397 | 8x<br>4211388  | 2x<br>4211103 | 2x<br>4210633 | 1x<br>4506014 |
| 4x<br>4190219  | 6x<br>4646577 | 2x<br>6039761 | 2x<br>4538950 | 4x<br>4211387  | 2x<br>4265794 |               | 1x<br>4506014 |
| 1x<br>4540552  | 2x<br>4533771 | 1x<br>4650900 | 1x<br>4568951 | 6x<br>4211393  | 2x<br>6000311 | 1x<br>4535833 | 1x<br>6037634 |
| 1x<br>6037618  | 2x<br>393726  | 1x<br>6037506 | 4x<br>4211220 | 8x<br>4211389  | 5x<br>4210935 | 1x<br>4297009 | 1x<br>6020190 |
|                | 2x<br>428626  | 1x<br>384926  | 4x<br>4211252 | 8x<br>4211441  | 1x<br>6039768 | 1x<br>6039768 | 1x<br>4615594 |
| 1x<br>6039818  | 4x<br>428626  | 1x<br>6039890 | 4x<br>6037454 | 4x<br>4211437  | 1x<br>4211024 | 1x<br>6039768 | 1x<br>4615594 |
| 2x<br>613421   | 3x<br>4565323 |               |               | 10x<br>4211614 | 3x<br>4211090 | 1x<br>6039768 | 1x<br>461883  |
| 1x<br>6034714  | 2x<br>366626  | 1x<br>6037638 | 2x<br>4271874 | 2x<br>4211436  | 4x<br>4558959 | 1x<br>6039758 | 1x<br>6039891 |
| 10x<br>4504380 | 2x<br>4144024 | 2x<br>4563681 | 3x<br>4211211 | 6x<br>6031056  | 4x<br>4221745 | 2x<br>4509884 | 1x<br>6000177 |
| 1x<br>4651236  |               | 2x<br>370526  | 6x<br>4211151 | 2x<br>4211436  | 2x<br>4211045 | 1x<br>6039771 | 1x<br>4614336 |
| 1x<br>379423   |               | 2x<br>4198367 | 1x<br>4225715 | 6x<br>6039770  | 4x<br>4221745 | 1x<br>4504649 |               |
| 2x<br>6011816  | 2x<br>6008363 |               | 1x<br>4221589 | 1x<br>6039739  | 2x<br>4211045 |               |               |
| 1x<br>4593757  | 2x<br>4185652 | 2x<br>4116671 | 1x<br>4221589 | 1x<br>6039740  | 1x<br>4620760 |               |               |
| 1x<br>4506727  | 4x<br>4121715 | 2x<br>4153989 | 2x<br>4211632 | 1x<br>6039740  | 2x<br>4211065 |               |               |
| 1x<br>4656483  |               |               |               |                |               |               |               |

**Customer Service**

**Kundenservice**

**Service Consommateurs**

**Servicio Al Consumidor**

**LEGO.com/service or dial**



**: 00800 5346 5555**

**: 1-800-422-5346**

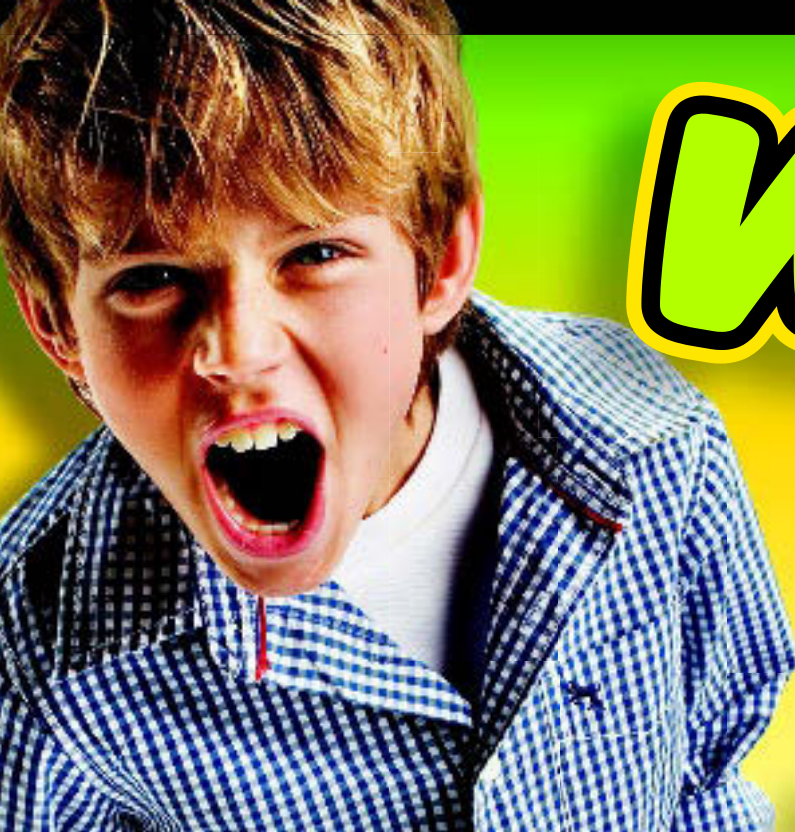

# WIN!

Go to [www.LEGOsurvey.com/product](http://www.LEGOsurvey.com/product) to fill out a survey for a chance to win a cool LEGO® Product.

No purchase necessary.

Open to all residents where not prohibited.



LEGO.com



## [www.LEGOsurvey.com/product](http://www.LEGOsurvey.com/product)

### GEWINNE! WIN!

Nimm an der Umfrage auf [www.LEGOsurvey.com/product](http://www.LEGOsurvey.com/product) teil und hab die Chance ein cooles LEGO® Produkt zu gewinnen!

Die Teilnahme am Gewinnspiel führt zu keinerlei Kaufverpflichtungen. Teilnahme in allen nicht ausgeschlossenen Ländern möglich.

Ga naar [www.LEGOsurvey.com/product](http://www.LEGOsurvey.com/product), vul een enquêteformulier in en maak kans op een cool LEGO® product.

Geen aankoopverplichting. Iedereen mag deelnemen, uitgezonderd ingezetenden van landen waar een enquêteverbod geldt.

### GAGNE! 当てよう!

Visite [www.LEGOsurvey.com/product](http://www.LEGOsurvey.com/product) pour répondre à un questionnaire et avoir une chance de gagner un produit LEGO® très cool!

Aucune obligation d'achat. Ouvert à tous les résidents des pays autorisés.

[www.LEGOsurvey.com/product](http://www.LEGOsurvey.com/product) にアクセスして、アンケートにご記入ください。当選者にはレゴ®製品を差し上げます。

お買い上げの必要はありません。

禁止されていない限り、すべての皆様にご利用いただけます。