



# NINJAGO

Masters of Spinjitzu



70720

70721

**70722**

70723

70724

70725

OVERBORG ATTACK

L'ATTAQUE D'OVERBORG

EL ATAQUE DE OVERBORG

1



2



3



4





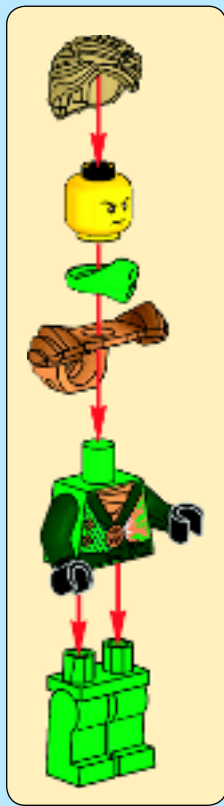
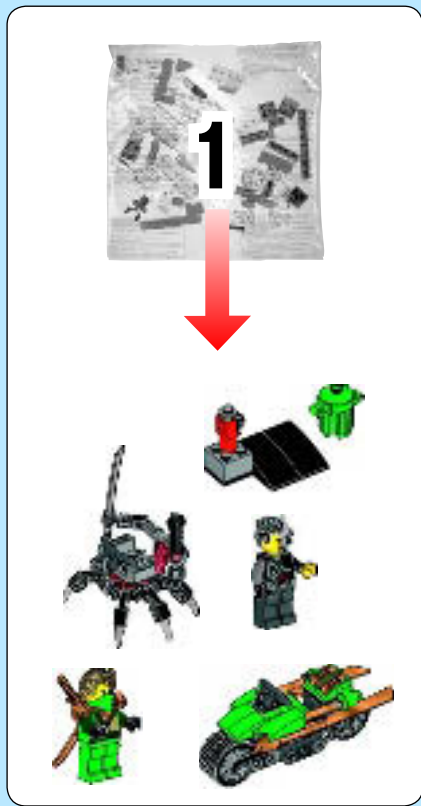

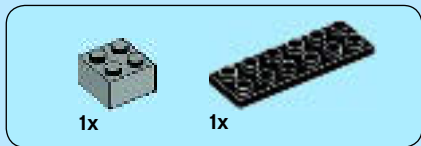
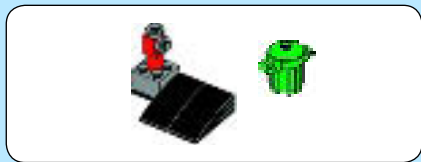

1

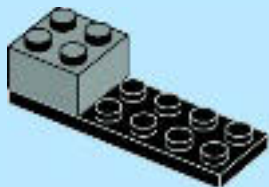

2

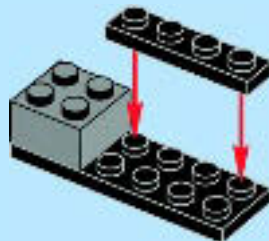



2x

3

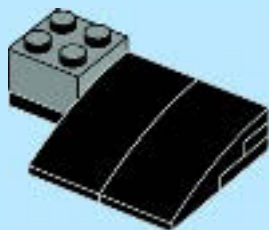

6



1x



1x



2x

4

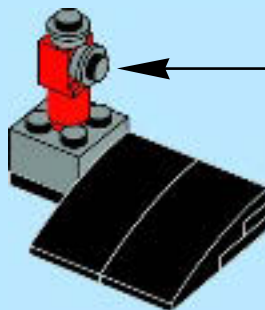
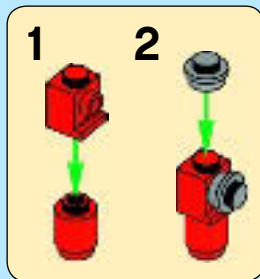



5

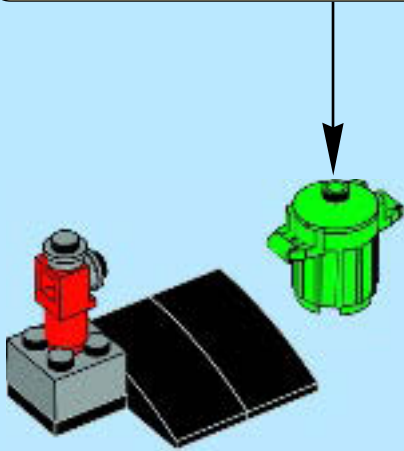
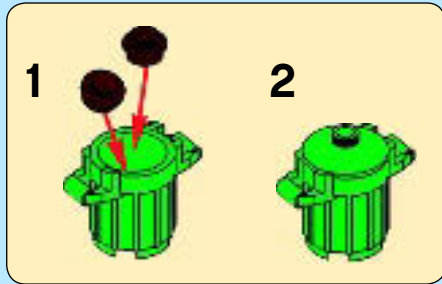



1



2





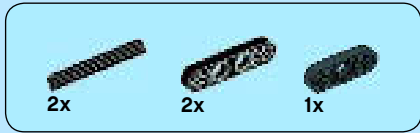

3

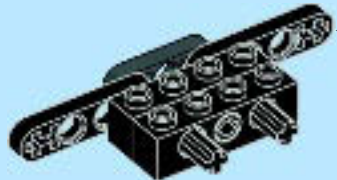
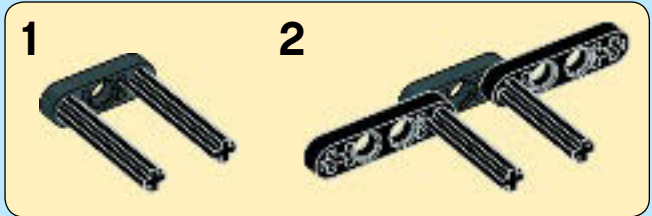



4

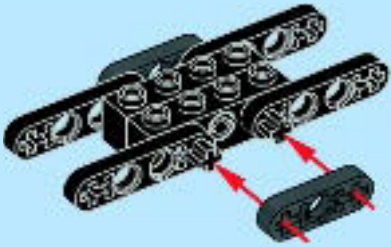

5

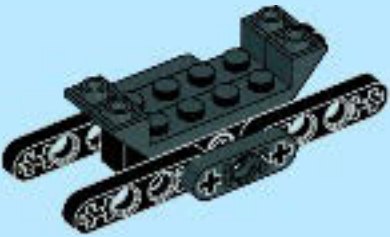



2x



2x

# 6

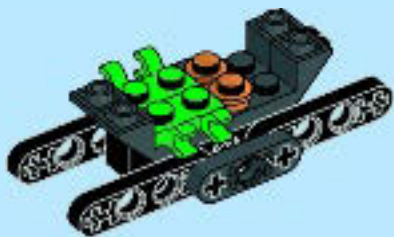

1x



2x

# 7

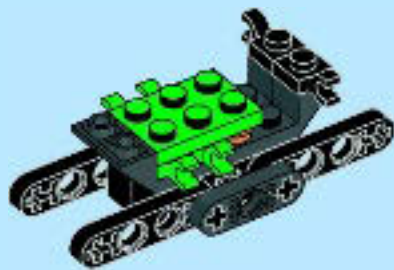

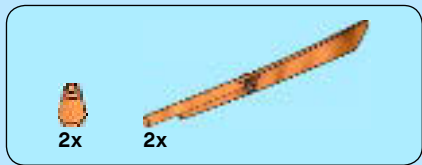

8

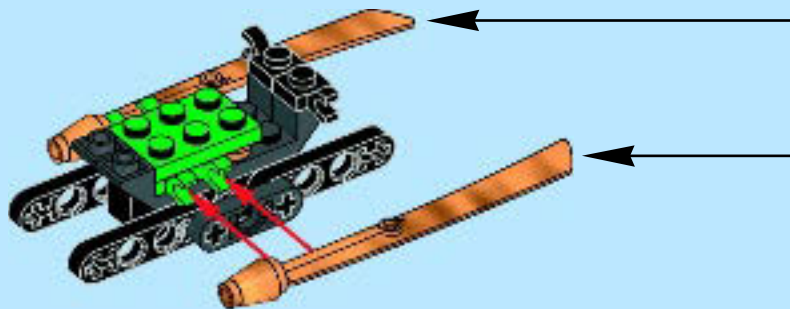
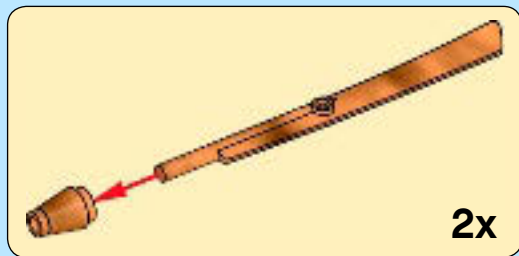

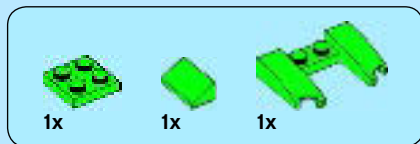

9

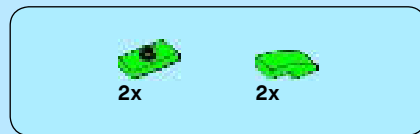
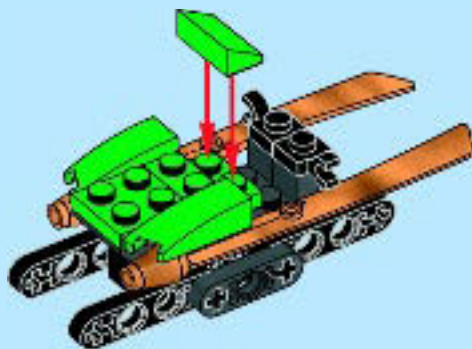

10

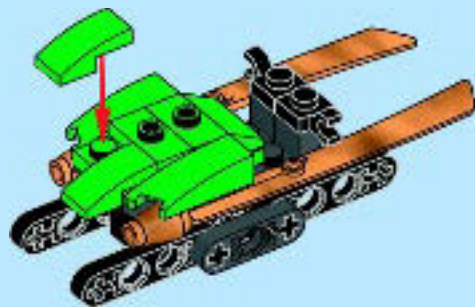



1x



1x

# 11



1x



2x

# 12

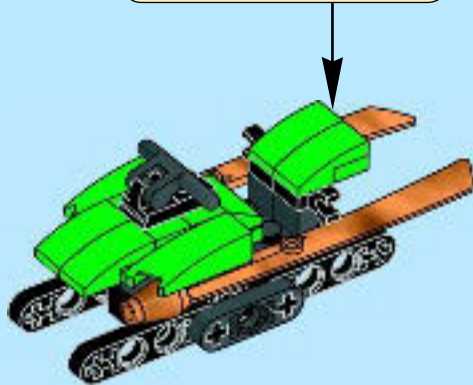
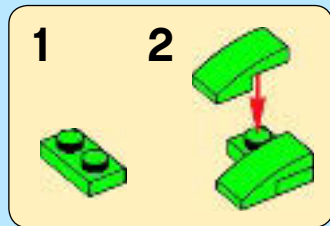

# 13

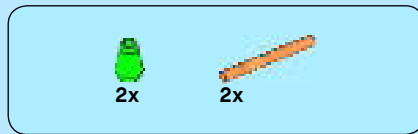
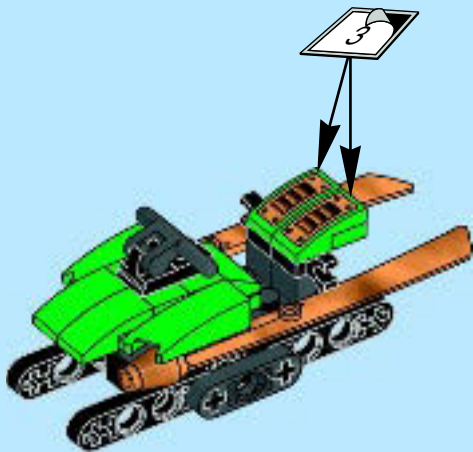

# 14

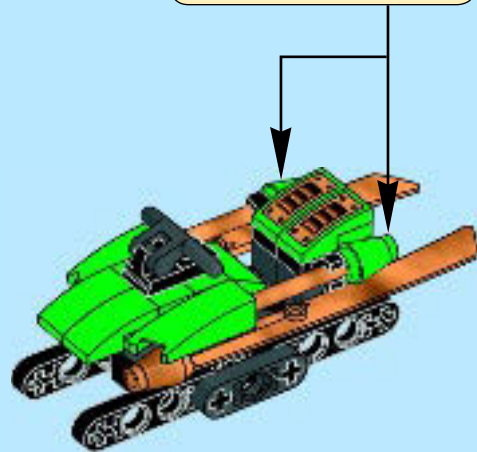
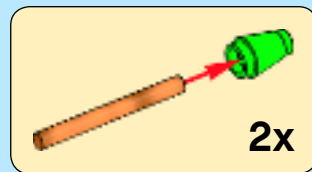

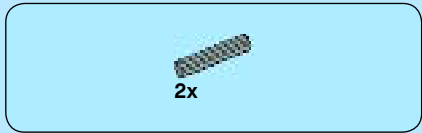

15

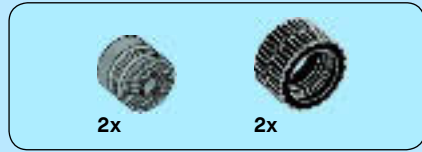
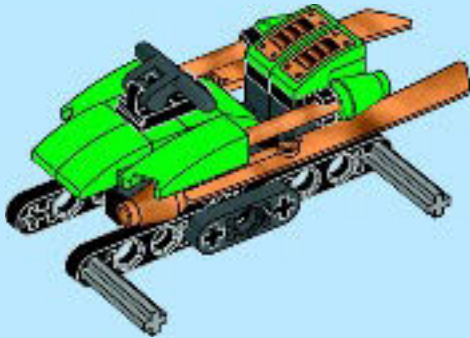

16

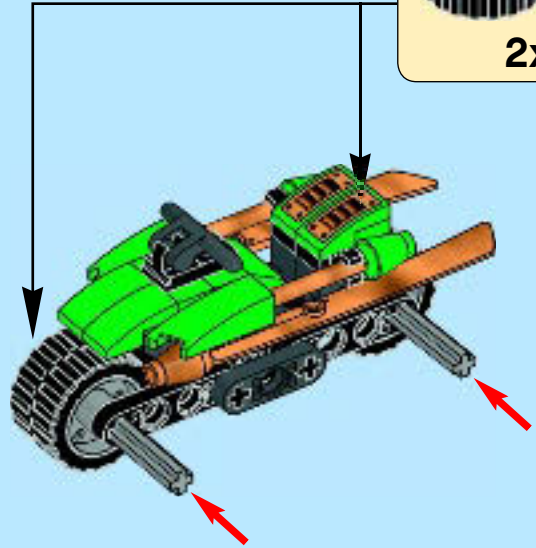
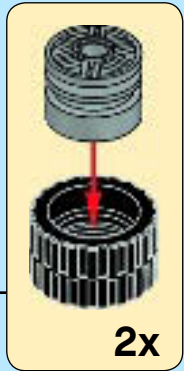







1

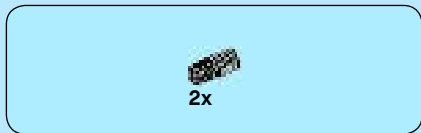

2





2x

3



1x



2x

4





1x



4x

5



4x



1x

6

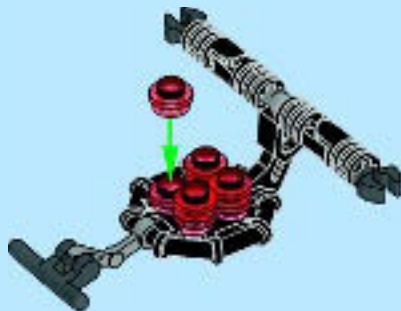



7

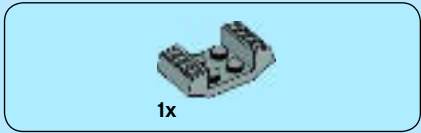
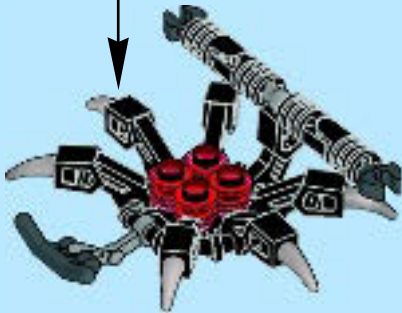
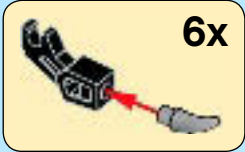

8

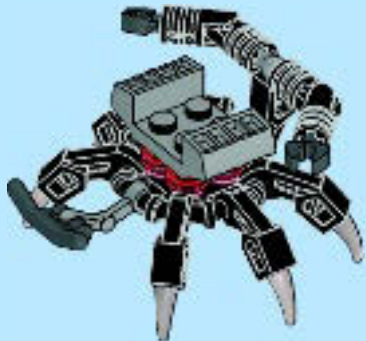

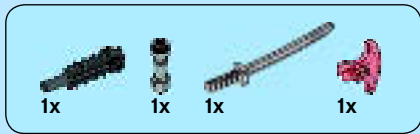

9

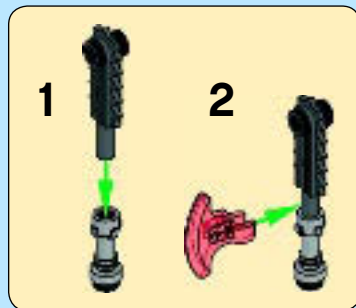

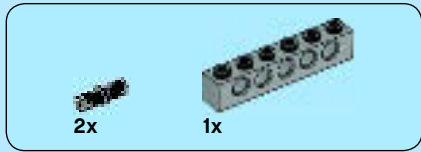
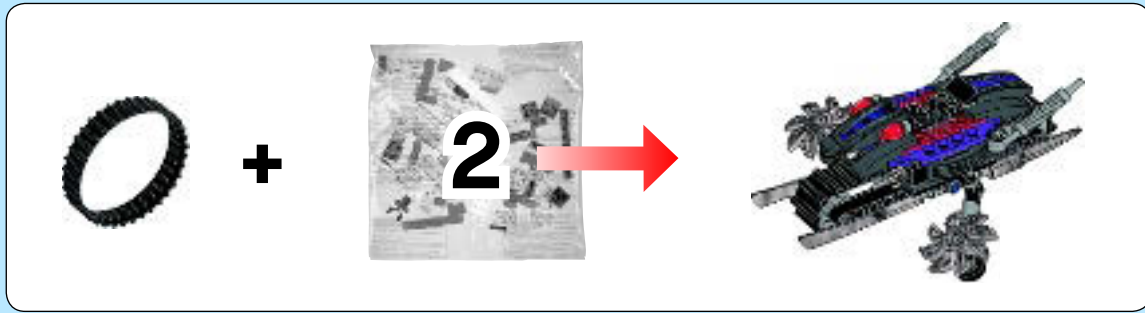

1

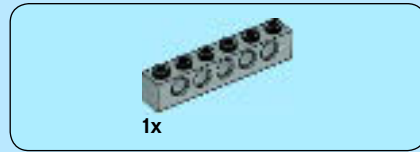
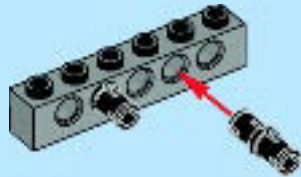

2





3

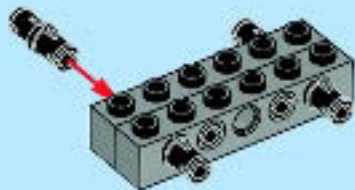

4





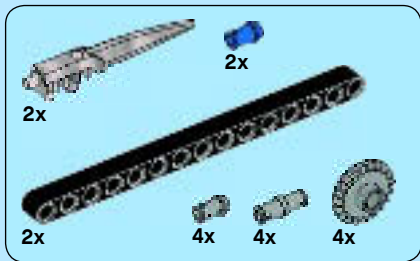

5

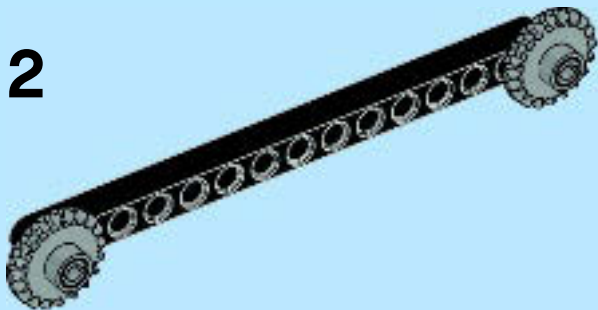

3

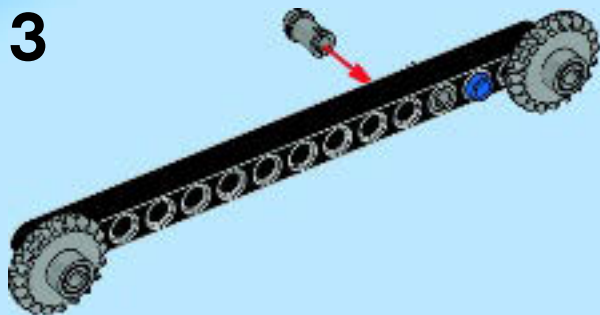

4

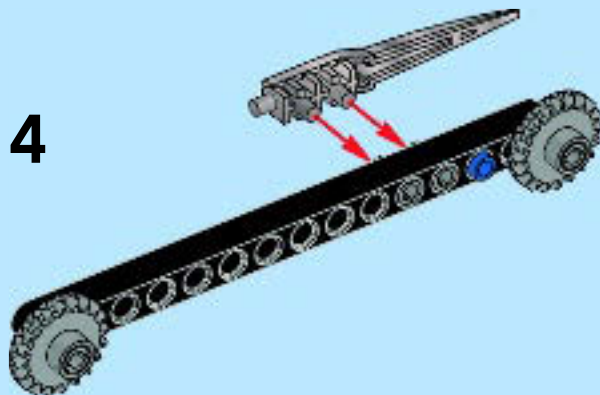

2x

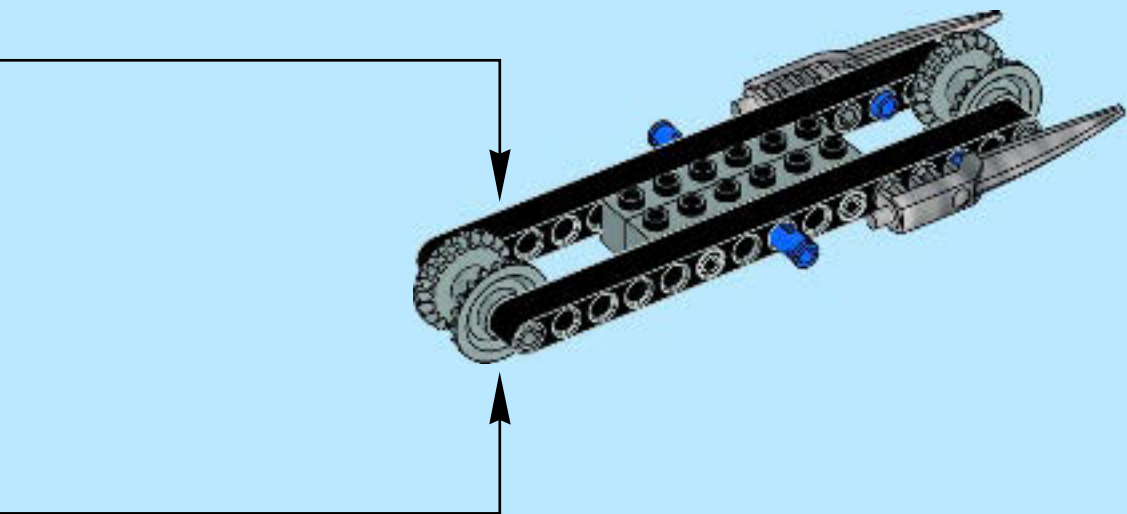



1

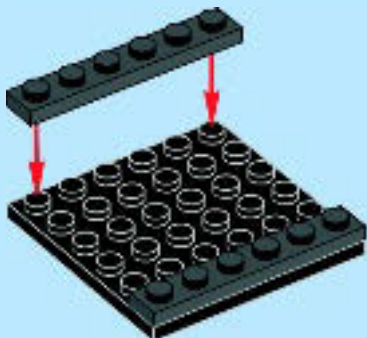

2

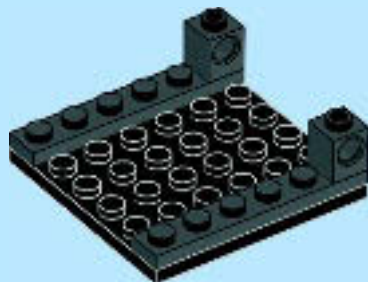

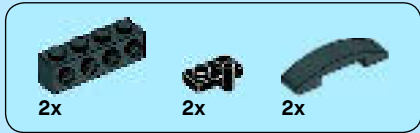

3

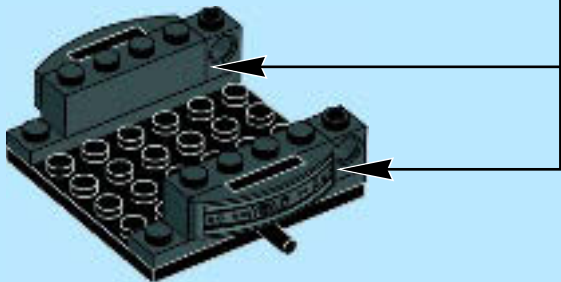



2x

4

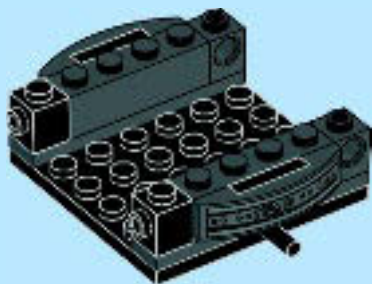

6

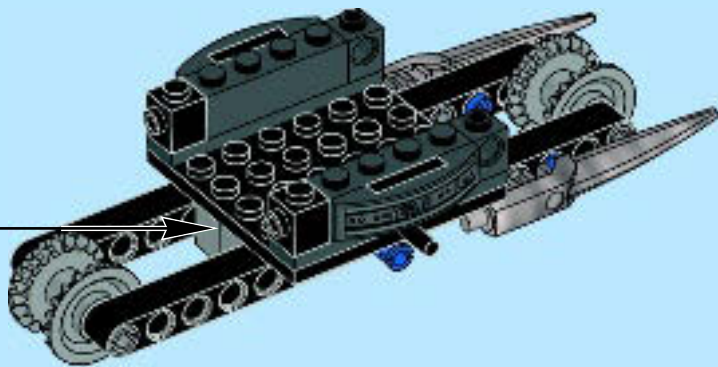

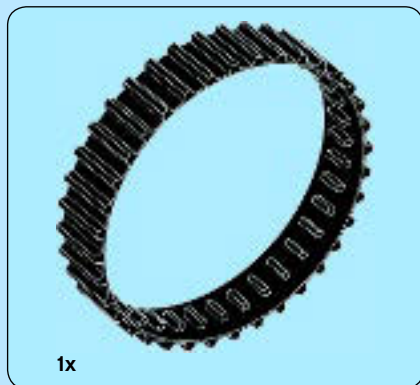

7

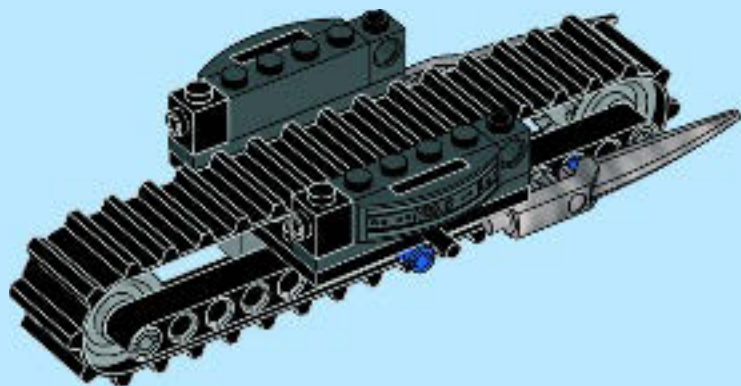

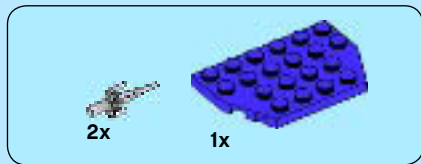

8

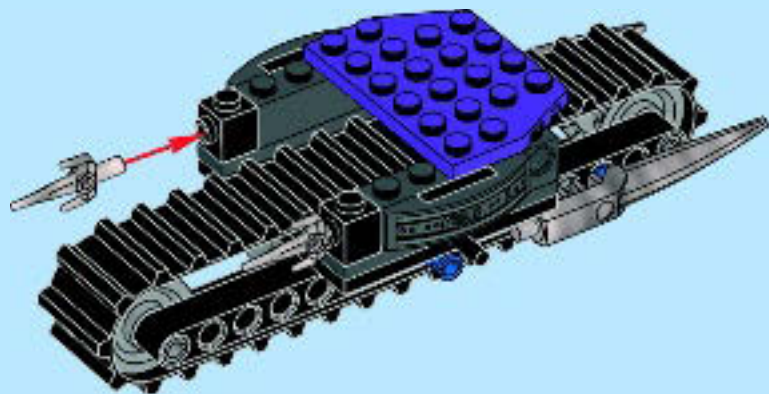



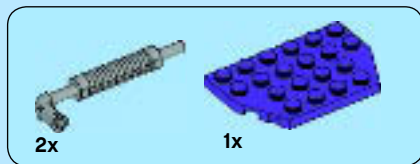

9

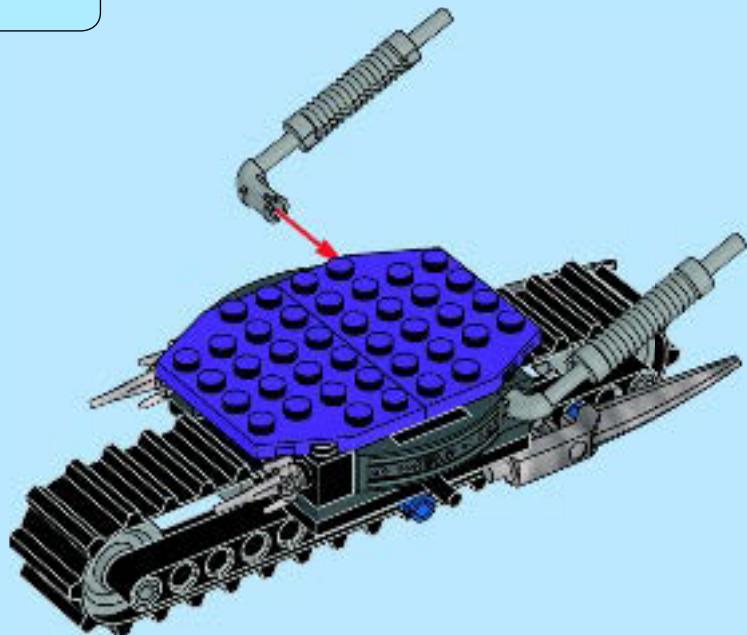

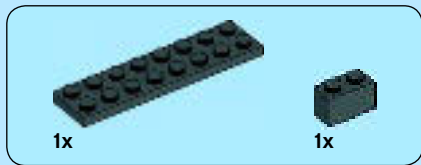

10

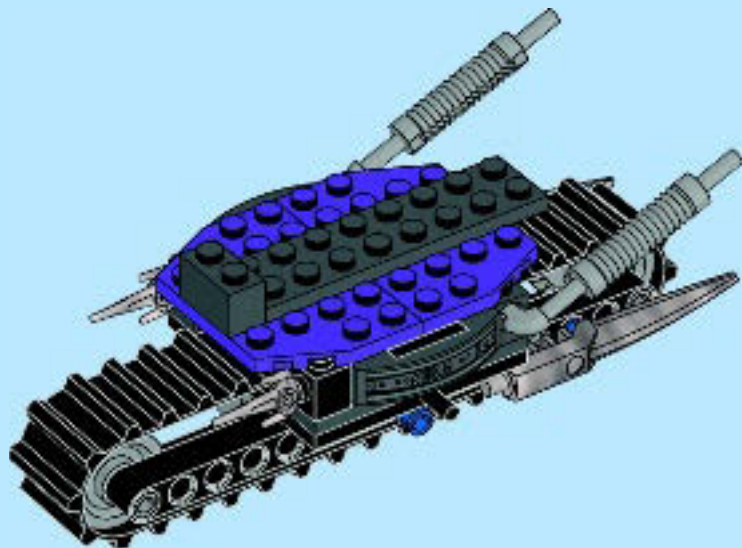



2x



4x



1x

# 11

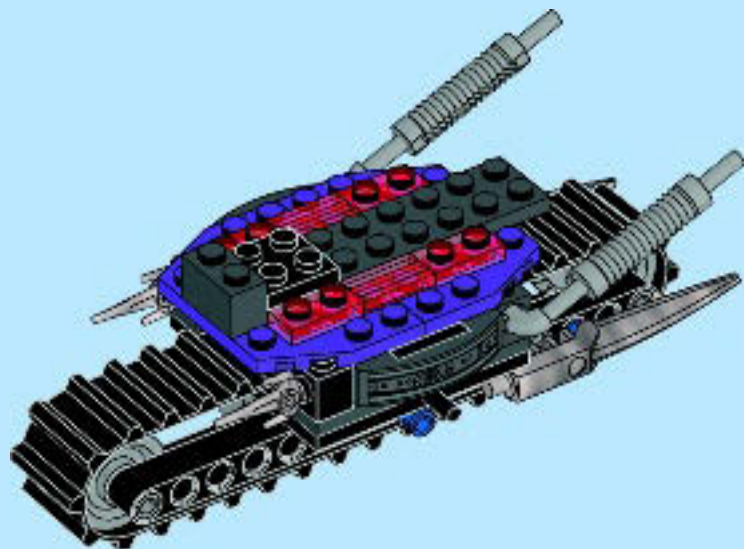



4x

# 12

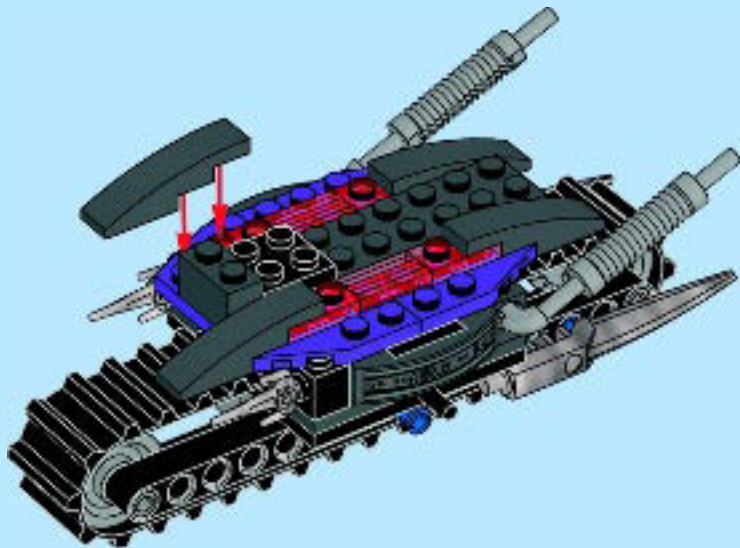

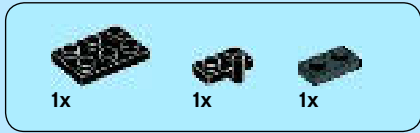

13

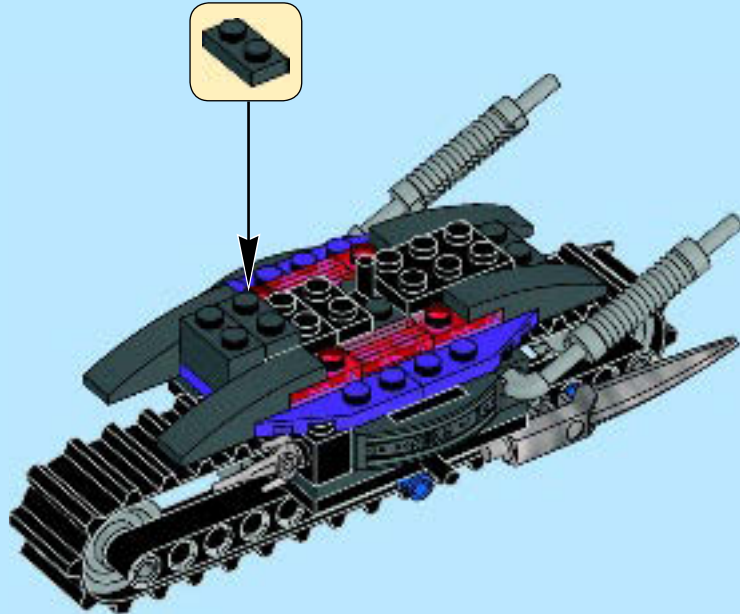



1x



2x

# 14

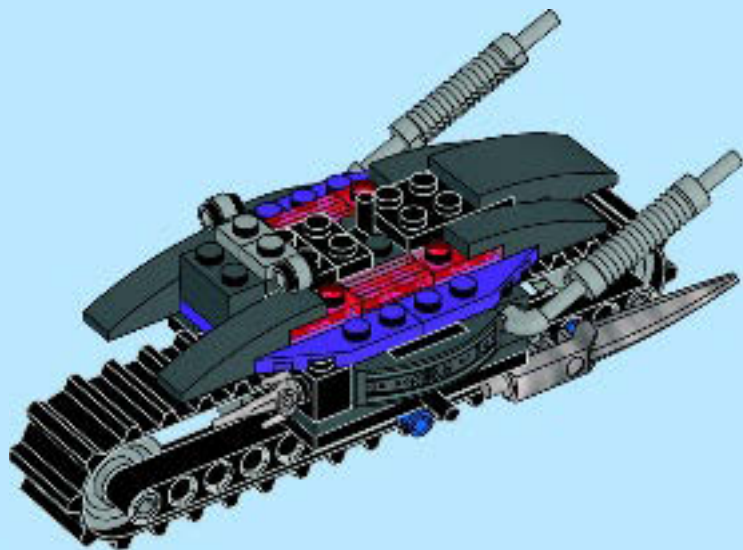



1x



1x

# 15

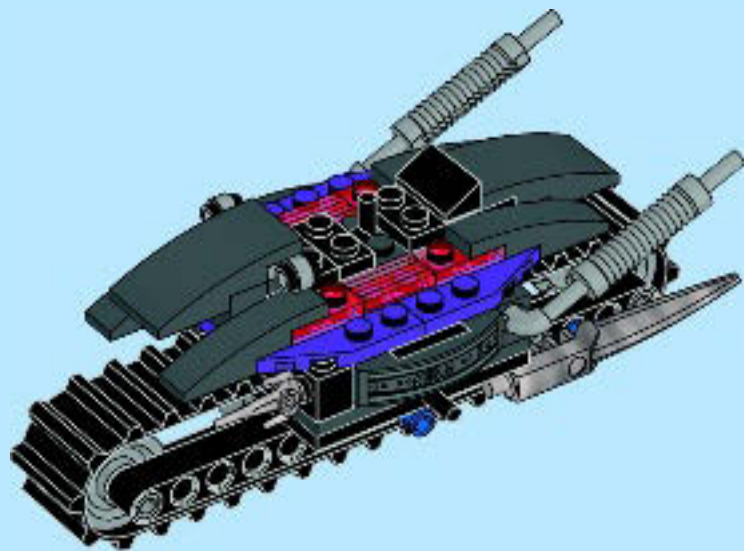



2x

# 16

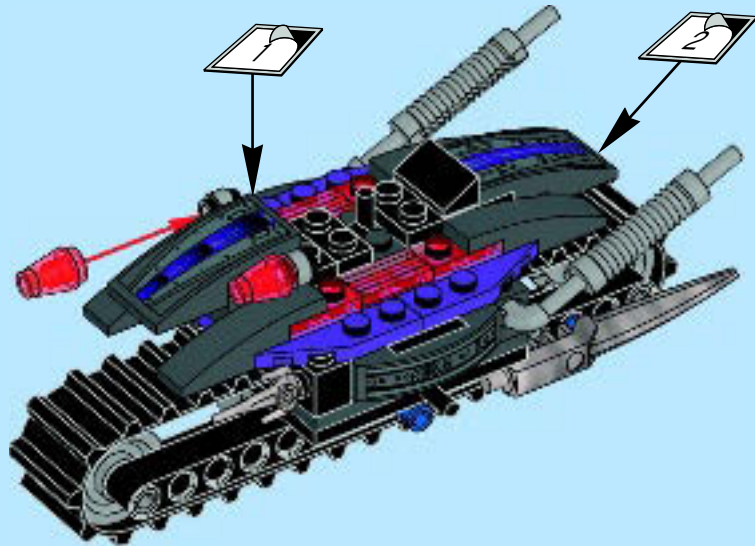



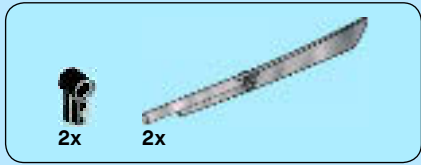

17

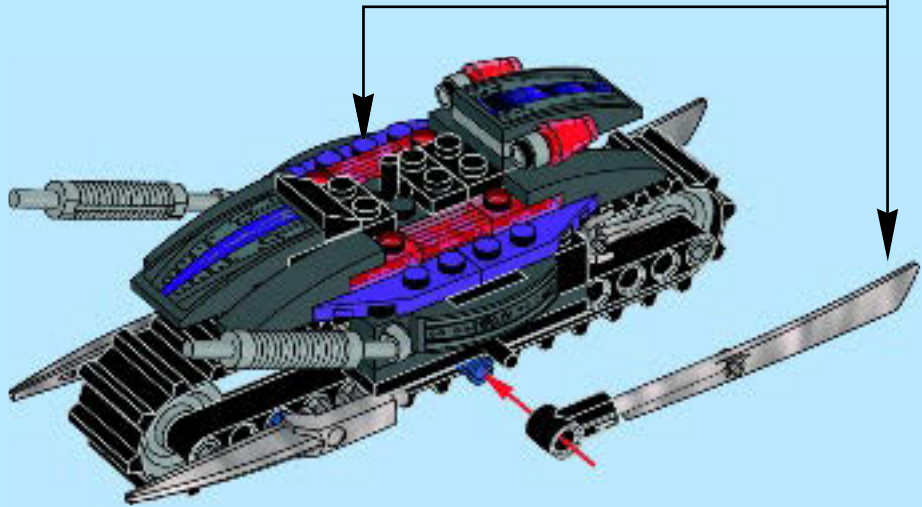
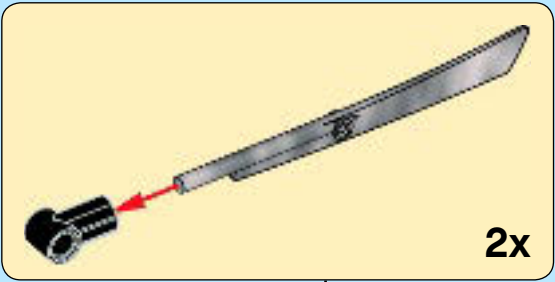



1



2

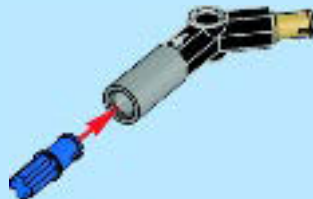



3



4

1



2

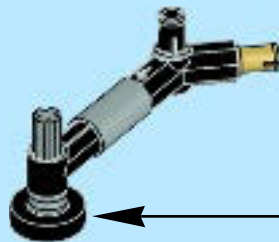



1x

5



18

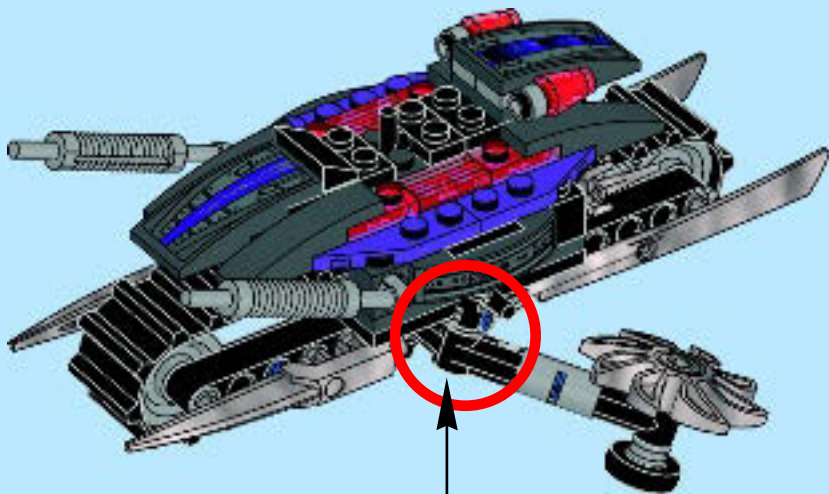



**1**



**2**

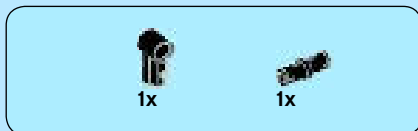

**3**



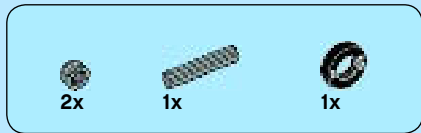

4

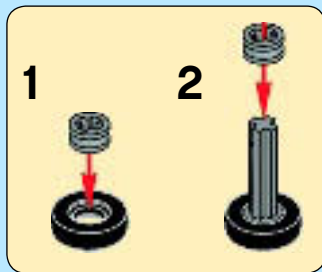

5

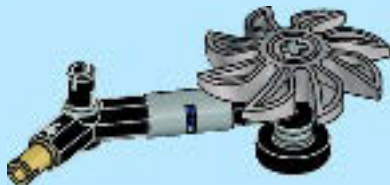

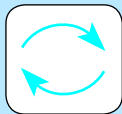

19

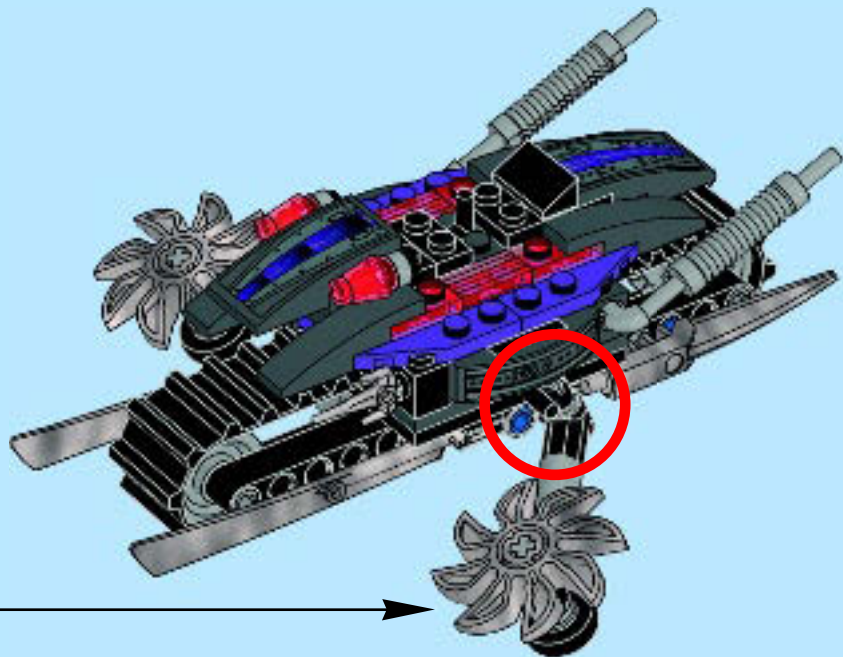

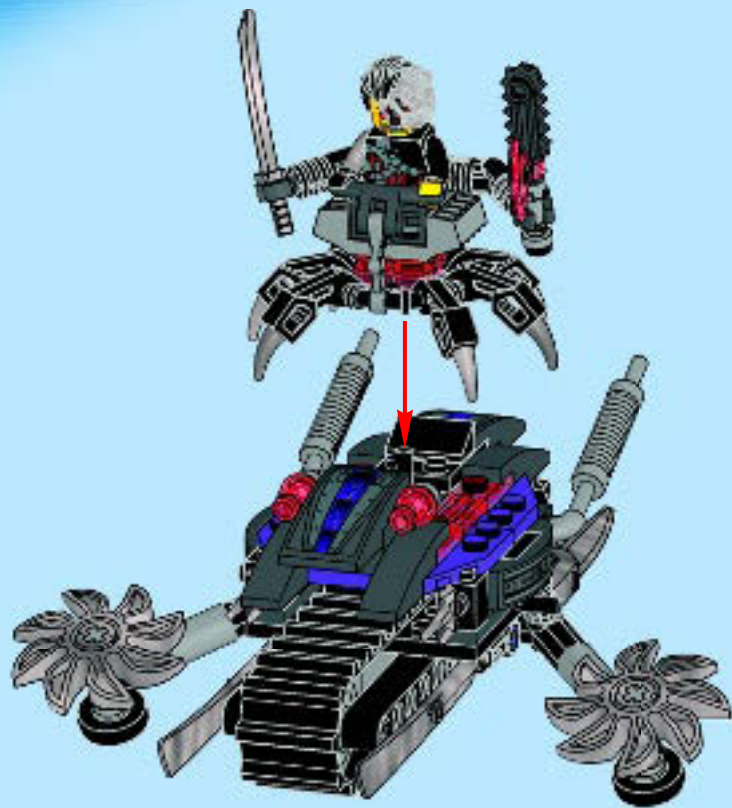



 1x 302226	 2x 4121610	 2x 4558954	 2x 4143372	 2x 4556159	 1x 4626650	 1x 6057767
 1x 371026	 9x 4121715	 2x 370126	 2x 370526	 1x 4567908	 1x 74040	 1x 6054819
 1x 379526		 1x 4548180	 1x 4598528	 1x 6032213	 1x 6058137	 2x 4666579
 1x 395826		 2x 4647286	 3x 4569733	 2x 4529239	 1x 6054857	 1x 407021
 1x 395826		 2x 4517925	 1x 6018805	 1x 6000071	 2x 4544720	 1x 306221
 2x 4542573		 1x 302126	 1x 6055778	 4x 6047426	 4x 4201019	 2x 4143005
 1x 6070518		 4x 4142236	 7x 6006739	 2x 379428	 2x 4190187	 4x 4206482
		 4x 4107085	 2x 4516843	 1x 302228	 8x 3005741	 2x 4514553
		 2x 4158848	 2x 4639695	 1x 302128	 1x 6024904	 1x 6057691
					 2x 4216581	 1x 6057958



1x  
4211387



2x  
4211466



2x  
4632575



2x  
4211525



1x  
4211658



2x  
4299119



1x  
4211748



2x  
6044706



4x  
4211573



4x  
4211483



1x  
4539481



4x  
4211807



2x  
4526985



4x  
4211815



1x  
4211508



4x  
4558690



1x  
4211088



2x  
4210725



2x  
4210639



1x  
4211063



1x  
4222693



1x  
4211048



2x  
4261908



2x  
4648256



4x  
6042955



2x  
6005668



2x  
4294180



2x  
4211056



2x  
4289542



2x  
4223767



1x  
4210997



2x  
6061548



2x  
4529247



2x  
4523159



2x  
4600267



1x  
6057641



2x  
4614404



2x  
4646843



6x  
4612901



2x  
4646867



1x  
4612900



2x  
6054533



2x  
6058339



2x  
4654422



**Customer Service**

**Kundenservice**

**Service Consommateurs**

**Servicio Al Consumidor**

**LEGO.com/service or dial**



**00800 5346 5555 :**



**1-800-422-5346 :**









# NINJAGO

Masters of Spinjitzu





# NINJAGO

Masters of Spinjitzu







# NINJAGO

Masters of Spinjitzu



**LLOYD**  
107122 / 107125



**KAI**  
107121



**JAY**  
107123



**COLE**  
107120 / 107123



**ZANE**  
107124



**SENSEI GARMADON**  
107126



**BYE-LI WU**  
MAYE-EP-TRUNG WU  
MAYE VADO WU  
107125



**GENERAL CRYPTOR**  
GENERAL CRYPTOR  
107121 / 107125



**NINDROID**  
107120 / 107124



**CYRUS BORG**  
107122



**NINDROID**  
107123 / 107124 / 107125



**PIXAL**  
107124



# NINJAGO

Masters of Spinjitzu



[LEGO.COM/NINJAGO](http://LEGO.COM/NINJAGO)

GO ONLINE FIND OUT MORE

VA EN LIGNE POUR EN SAVOIR PLUS

MÁS INFORMACIÓN EN INTERNET





# WIN!

Go to [LEGO.com/productfeedback](http://LEGO.com/productfeedback) to fill out a survey for a chance to win a cool LEGO® Product.

No purchase necessary.  
Open to all residents where not prohibited.



## LEGO.com/productfeedback

### GEWINNE!

Nimm an der Umfrage auf [LEGO.com/productfeedback](http://LEGO.com/productfeedback) teil und hab die Chance ein cooles LEGO® Produkt zu gewinnen!

Die Teilnahme am Gewinnspiel führt zu keinerlei Kaufverpflichtungen. Teilnahme in allen nicht ausgeschlossenen Ländern möglich.

### WIN!

Ga naar [LEGO.com/productfeedback](http://LEGO.com/productfeedback), vul een enquêteformulier in en maak kans op een cool LEGO® product.

Geen aankoopverplichting.  
Iedereen mag deelnemen, uitgezonderd ingezetenden van landen waar een enquêteverbod geldt.

### GAGNE!

Visite [LEGO.com/productfeedback](http://LEGO.com/productfeedback) pour répondre à un questionnaire et avoir une chance de gagner un produit LEGO® très cool!

Aucune obligation d'achat.  
Ouvert à tous les résidents des pays autorisés.

### 当てよう!

[LEGO.com/productfeedback](http://LEGO.com/productfeedback) にアクセスして、アンケートにご記入ください。当選者にはレゴ®製品を差し上げます。

お買い上げの必要はありません。  
禁止されていない限り、すべての皆様にご利用いただけます。



6088067

LEGO and the LEGO logo are trademarks of the/son des marques de commerce de/son marcas registradas de LEGO Group. ©2014 The LEGO Group.