



# NINJAGO

Masters of Spinjitzu

70720

70721

70722

**70723/2**

70724

70725



THUNDER RAIDER

LE VÉHICULE ÉCLAIR

EL CAZA TERRESTRE DEL TRUENO



2x

+



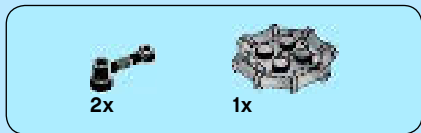
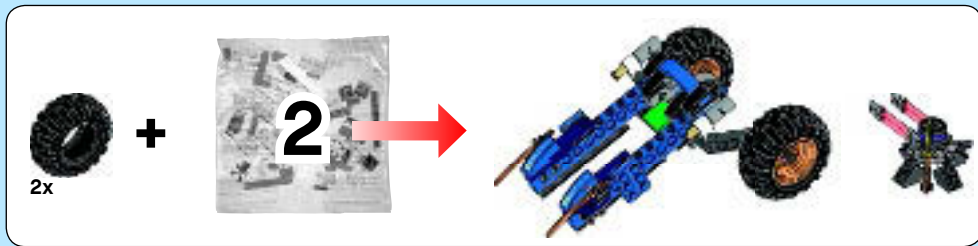

1



2





1x



1x

3



4



4x



4x

4

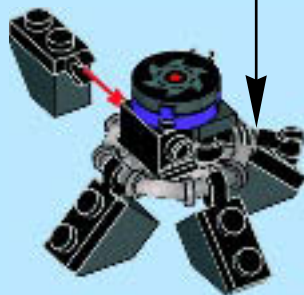
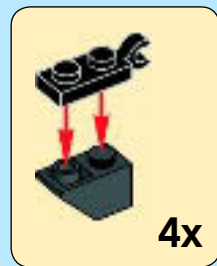



5

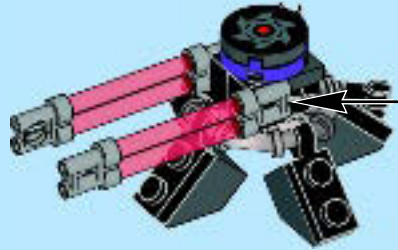
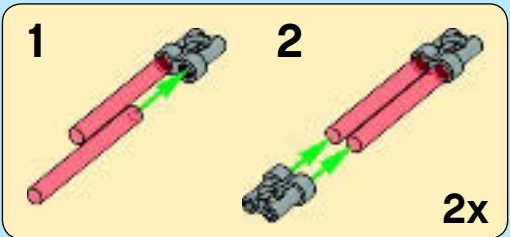

6

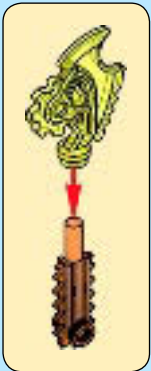

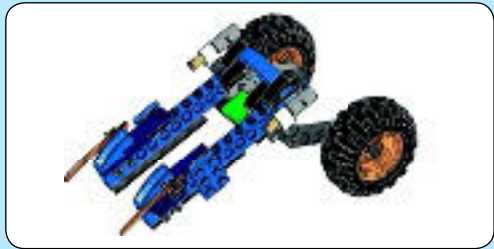

1

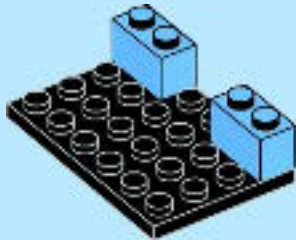

2

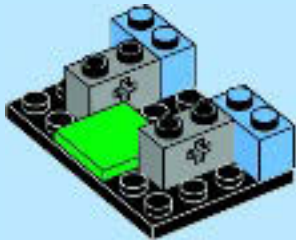



3

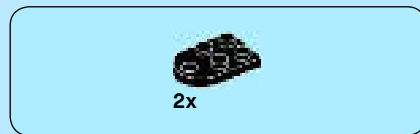
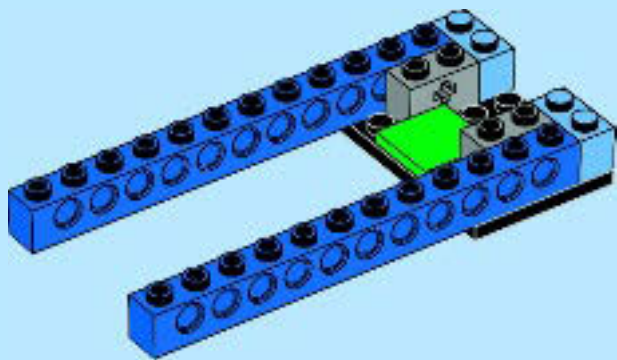

4

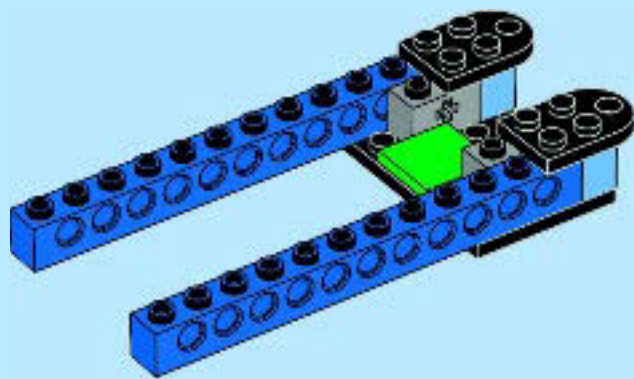



5

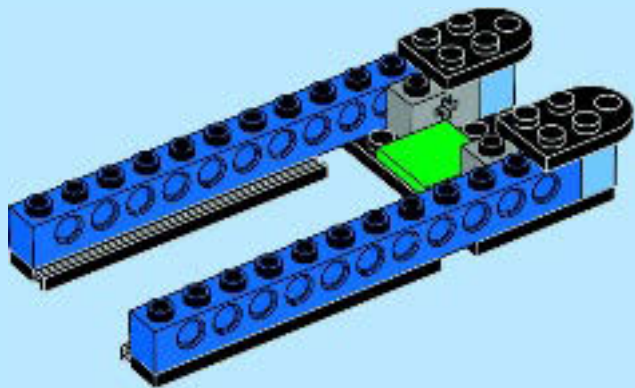

8

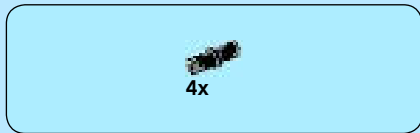

6

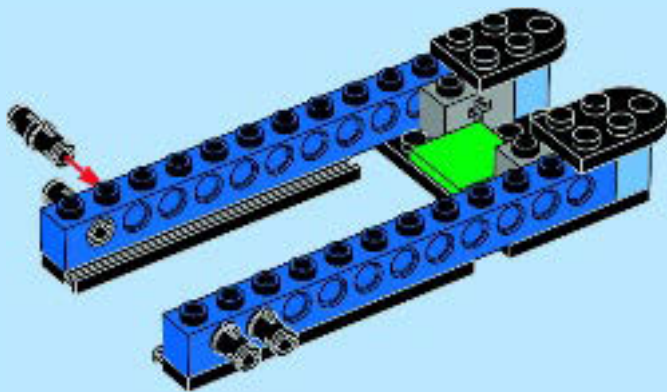





7

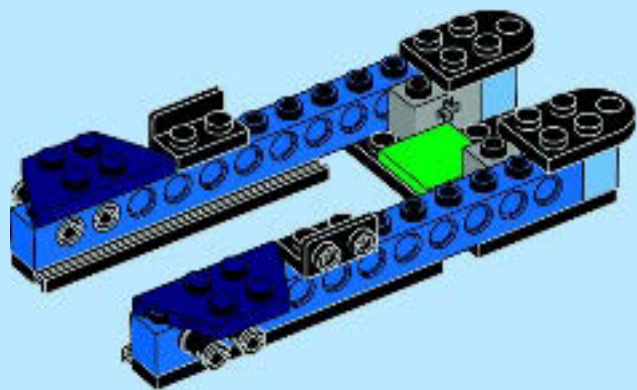

8

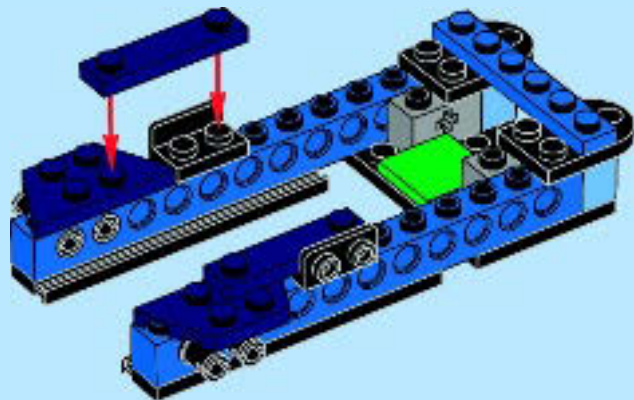



2x



2x

9

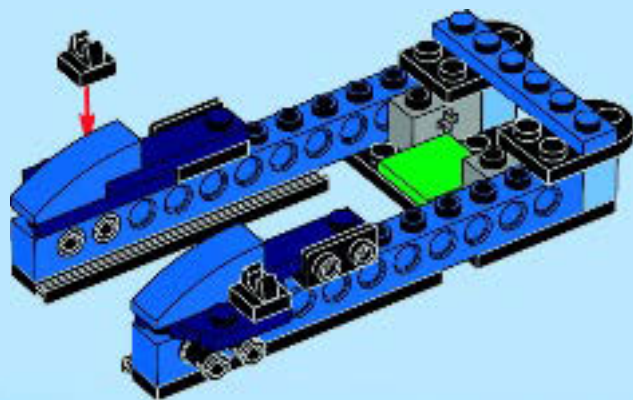



# 10

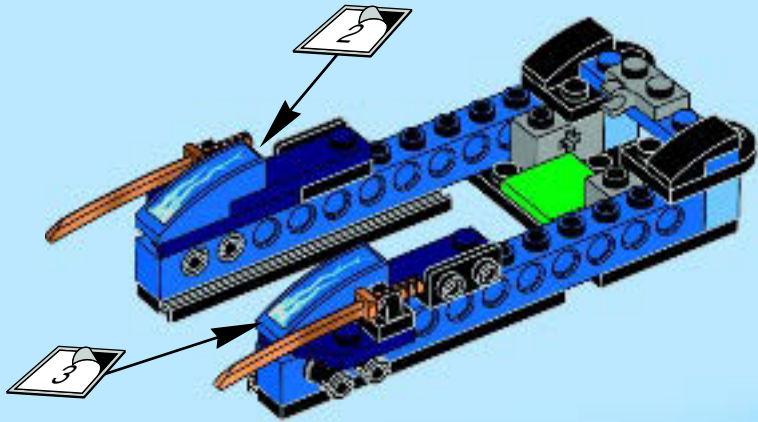



1x



2x

# 11

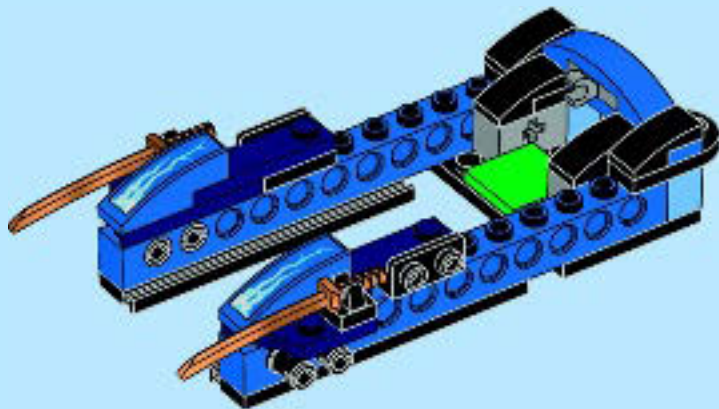



2x

# 12

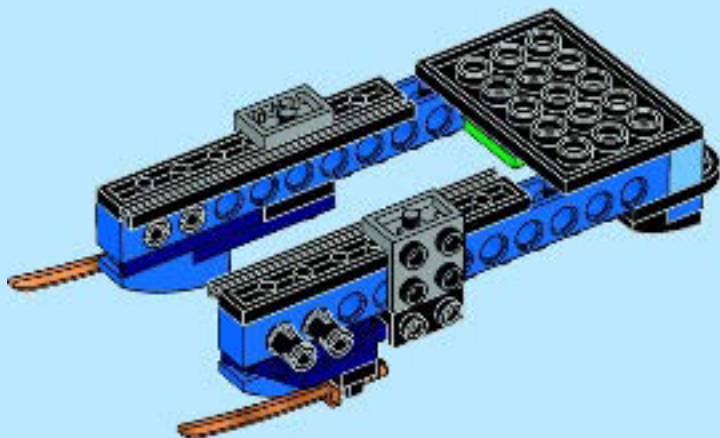
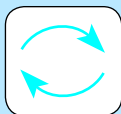

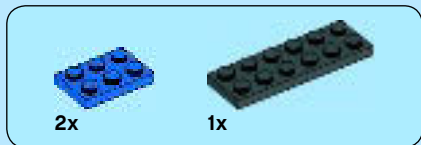

13

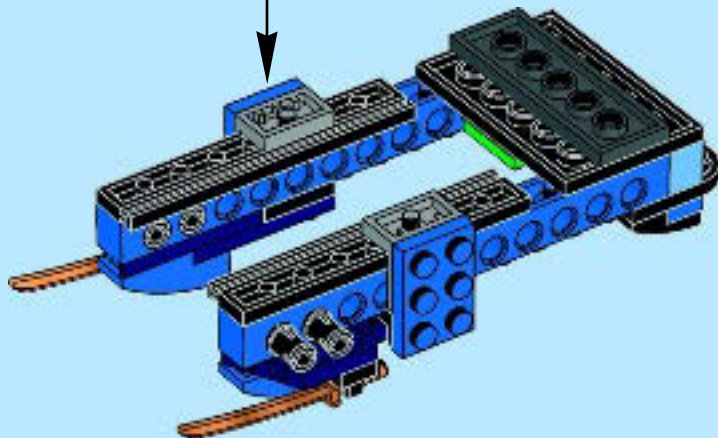

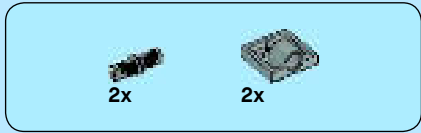

14

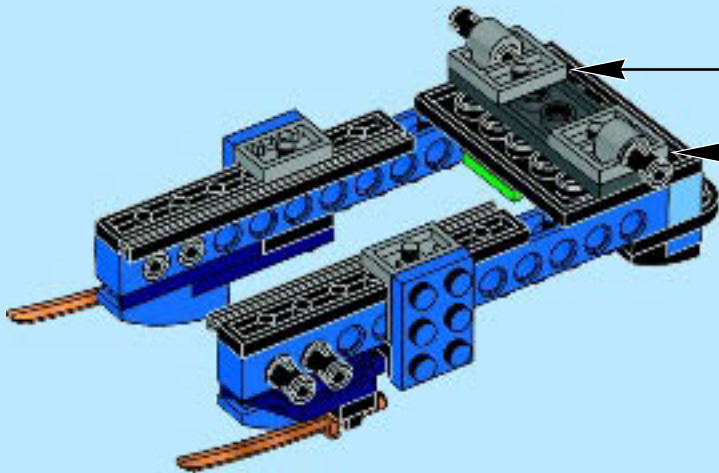
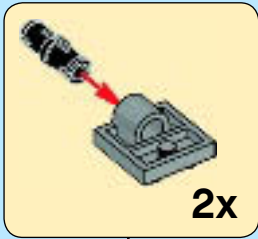

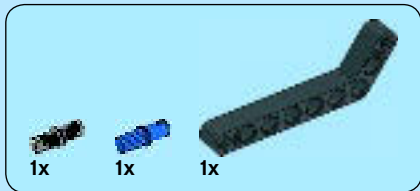

1

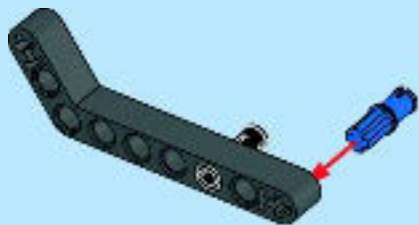

2

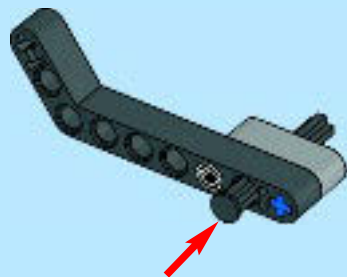



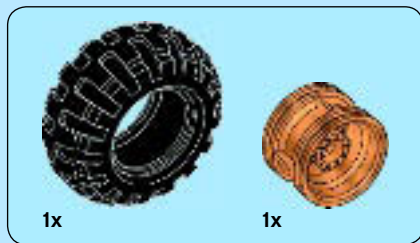

3

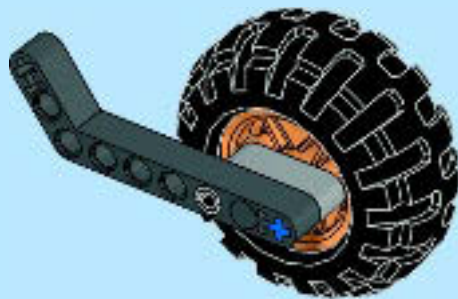
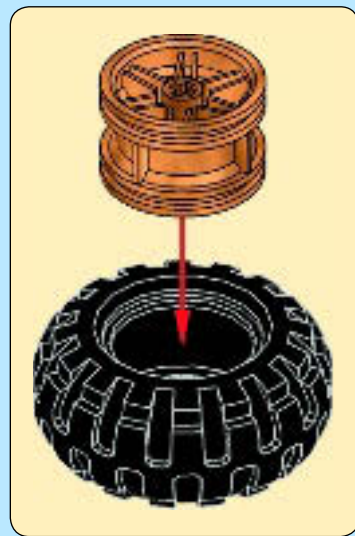

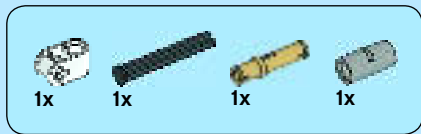

4

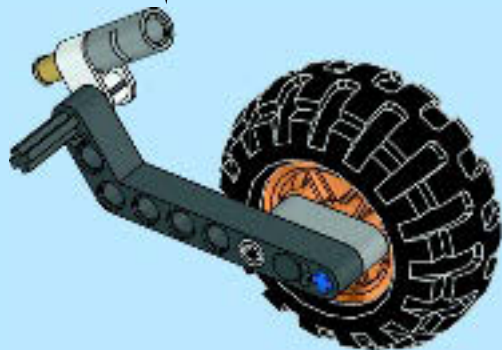
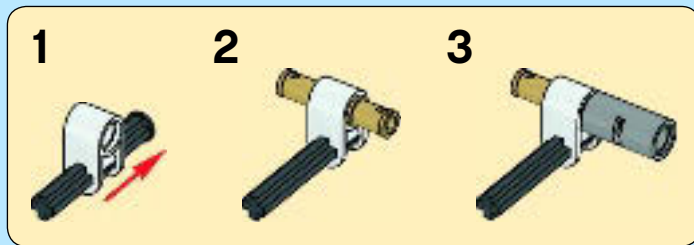

15

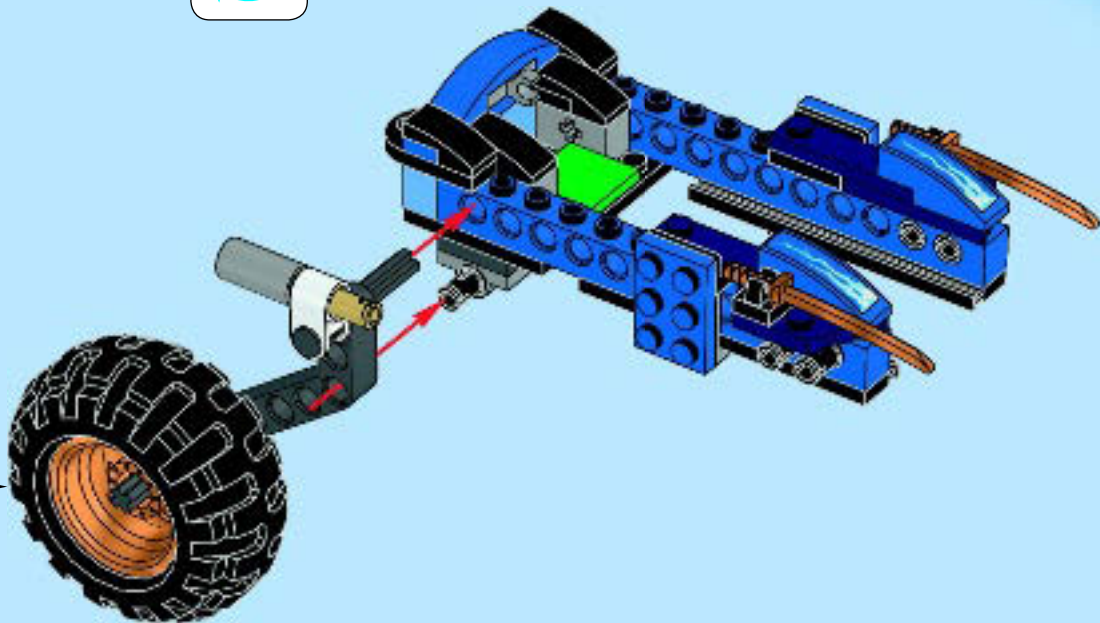
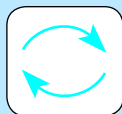

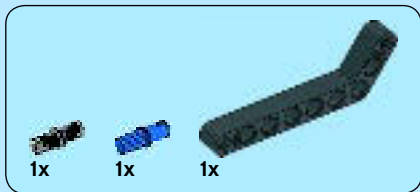

1

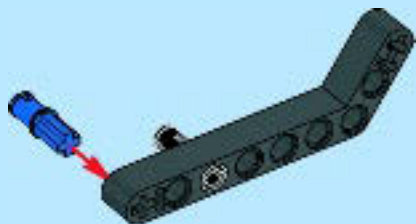

2

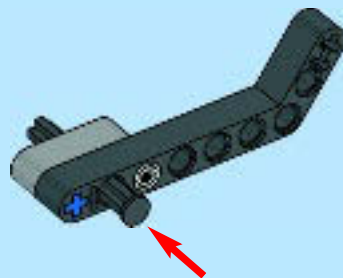

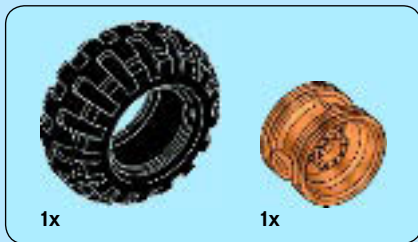

3

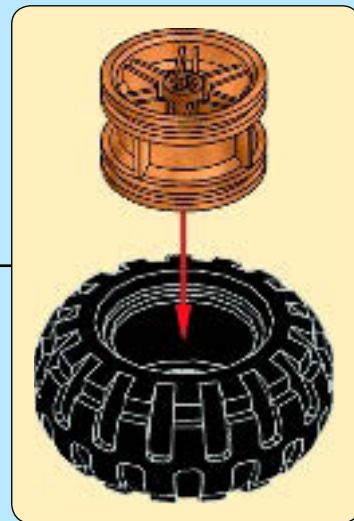
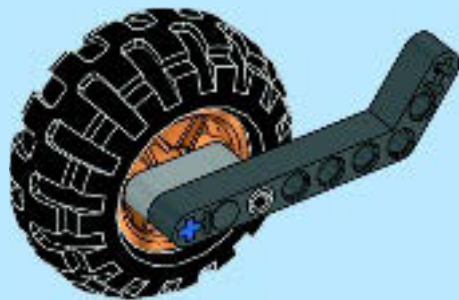

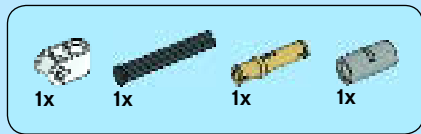

4

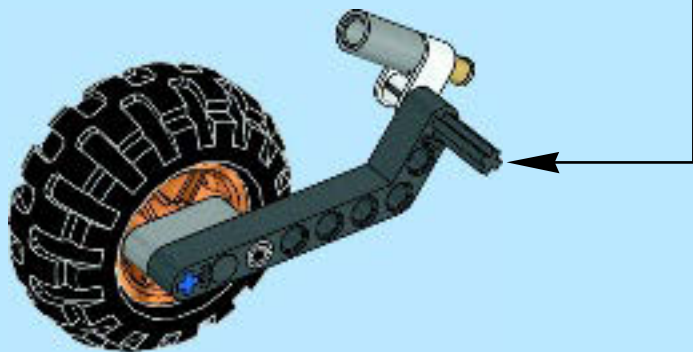

16

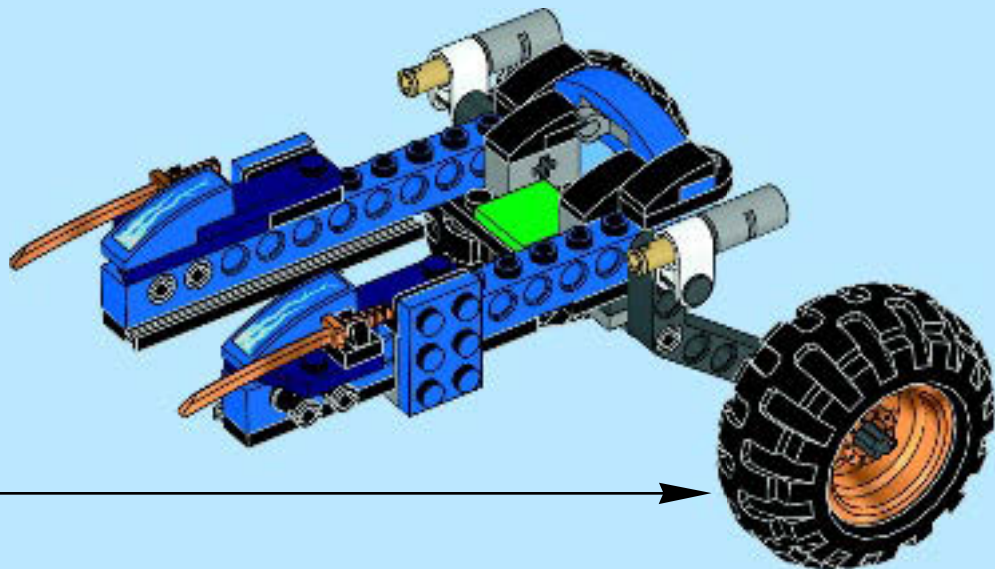
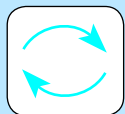

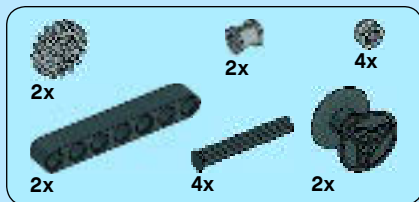

17

1



2

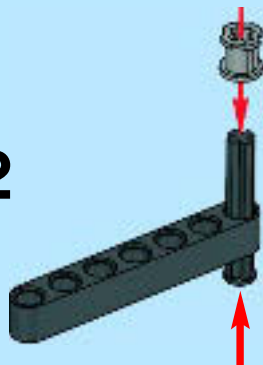



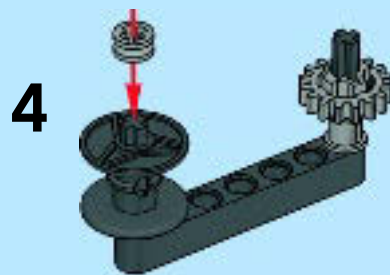
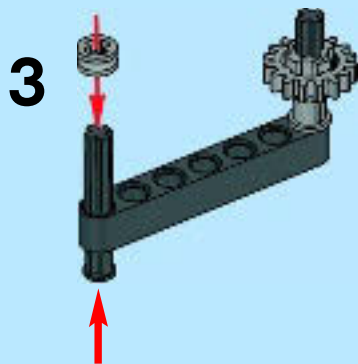

**2x**

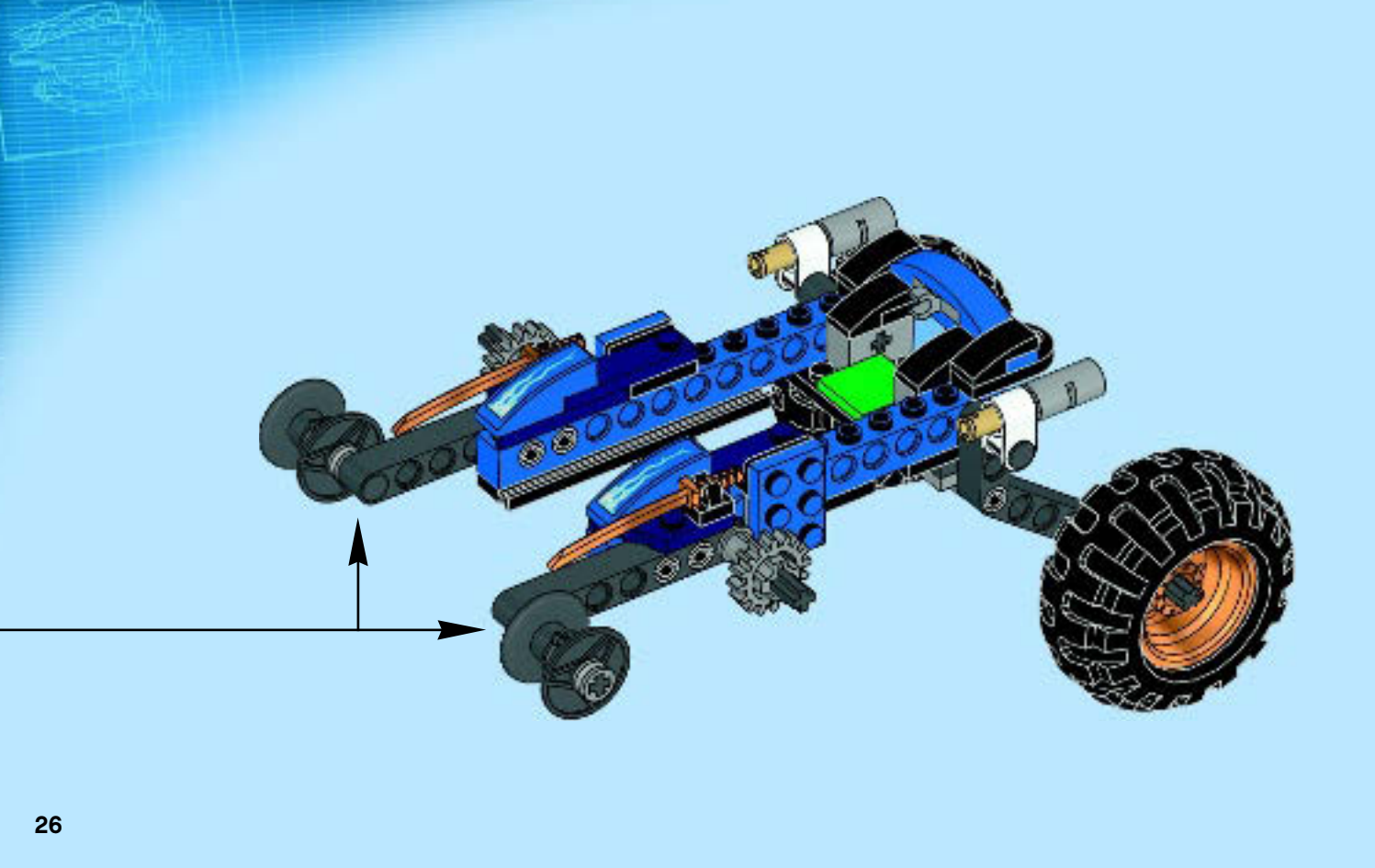



18

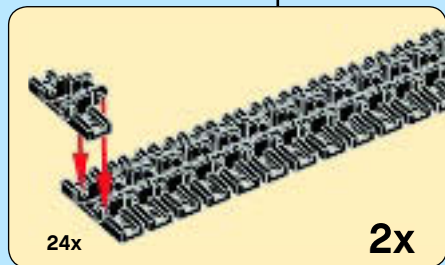
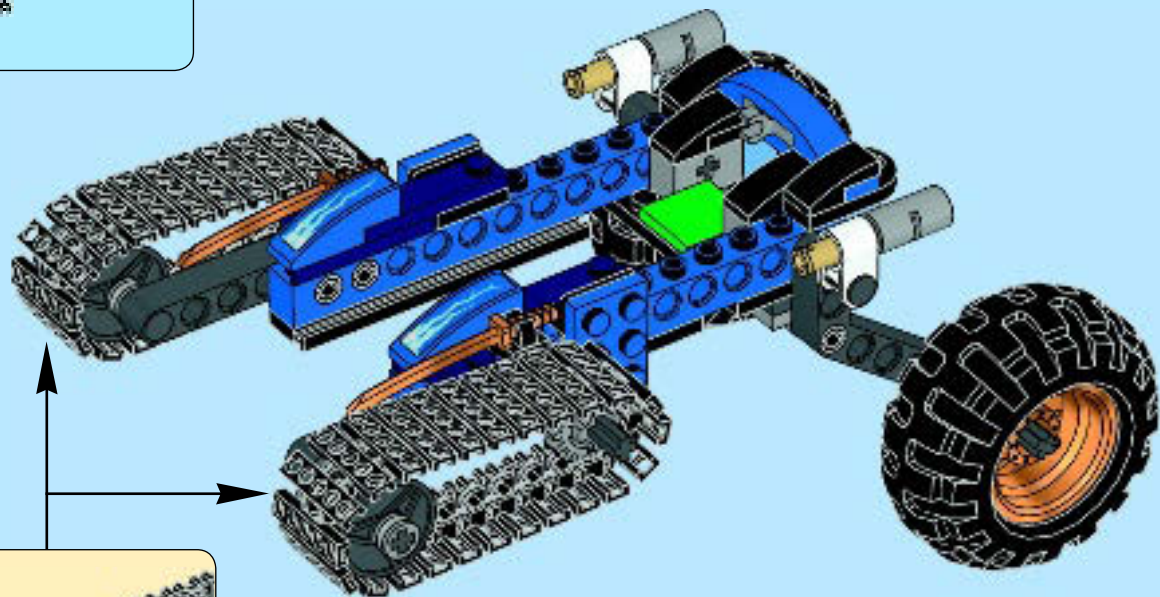

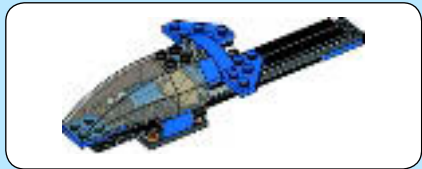

1

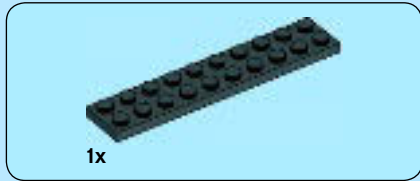

2



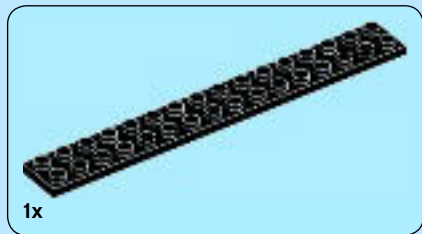

**3**

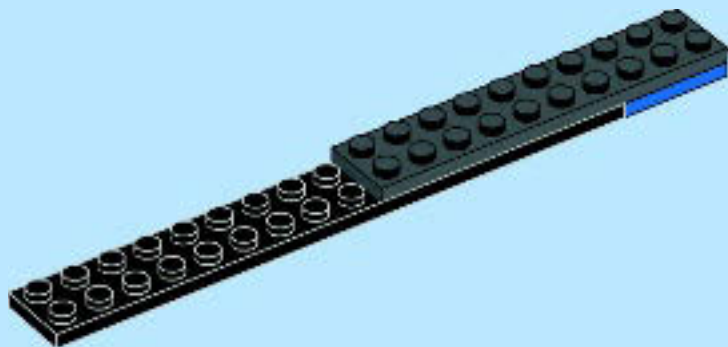



1x

4



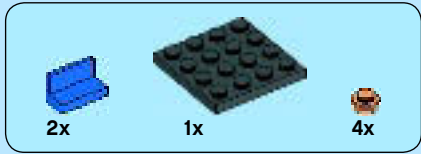

5

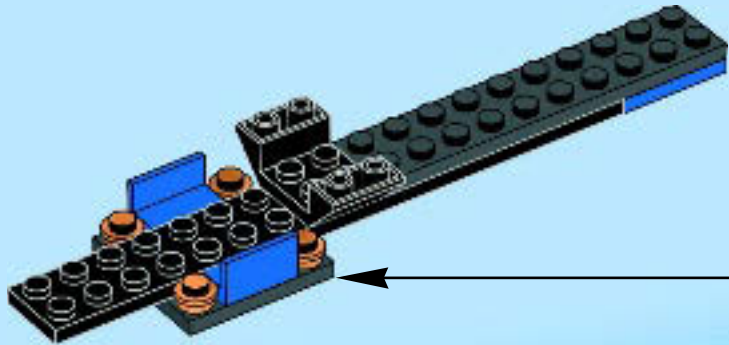
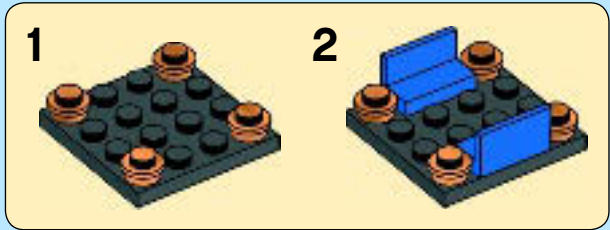

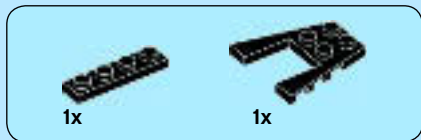

6

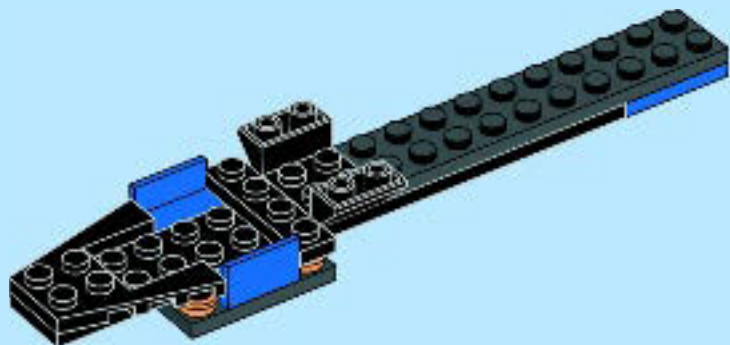





7

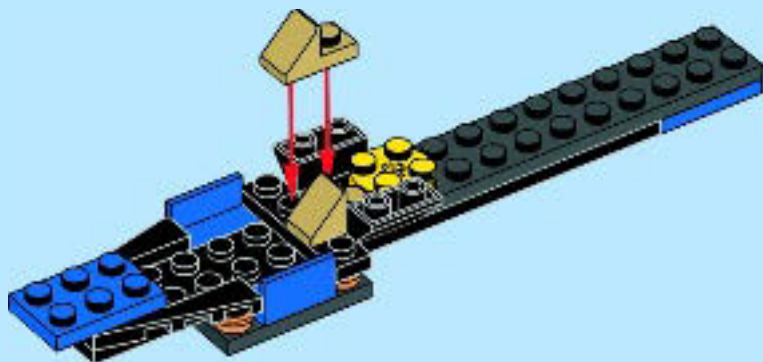

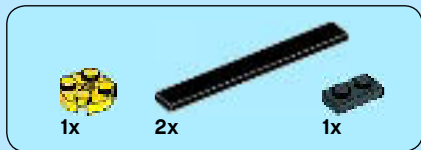

8

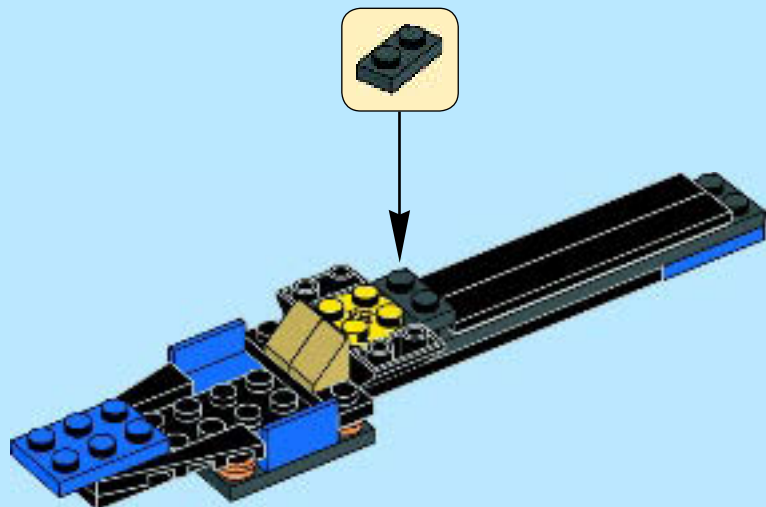



1x



1x

9

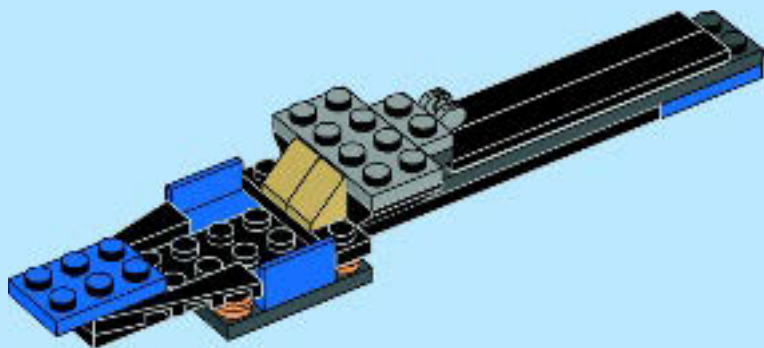



1x



1x



1x

# 10

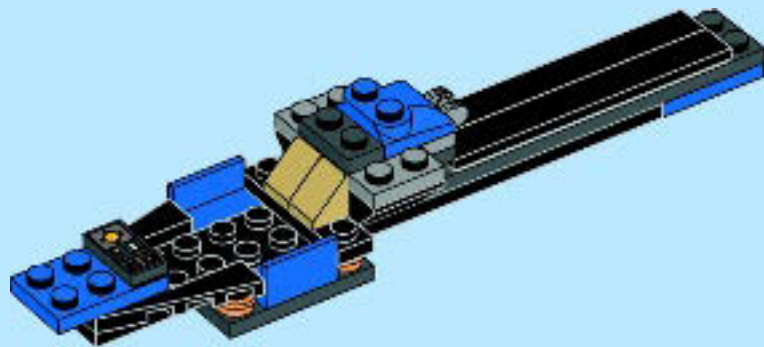



2x

11

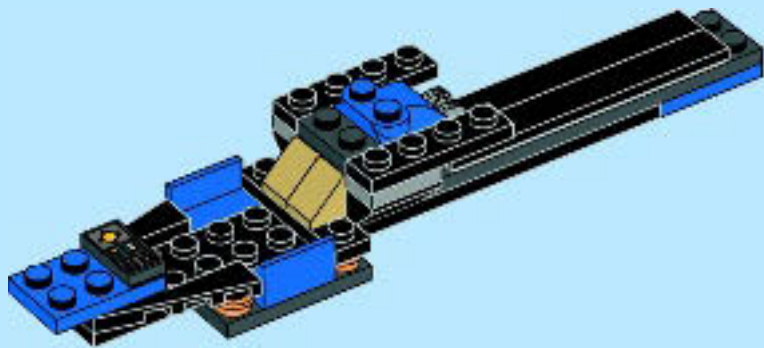



2x

12

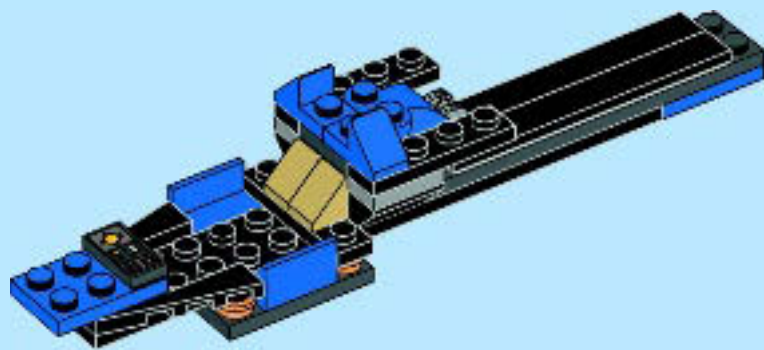



2x

13

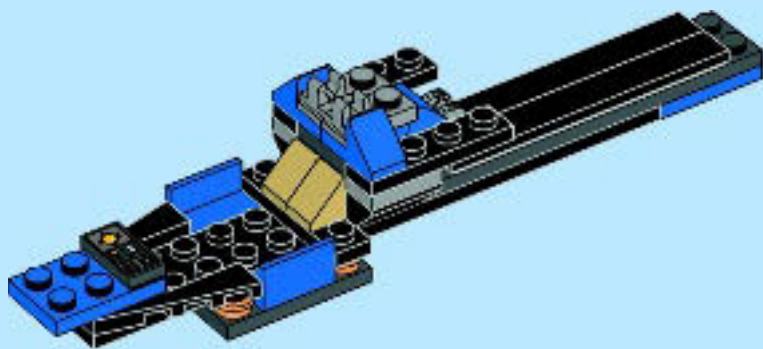



2x

14

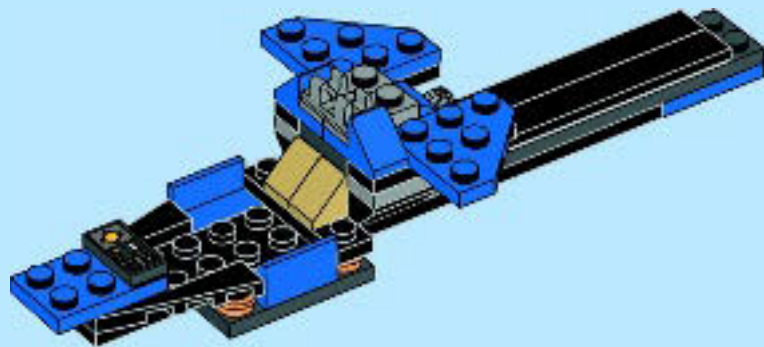





15

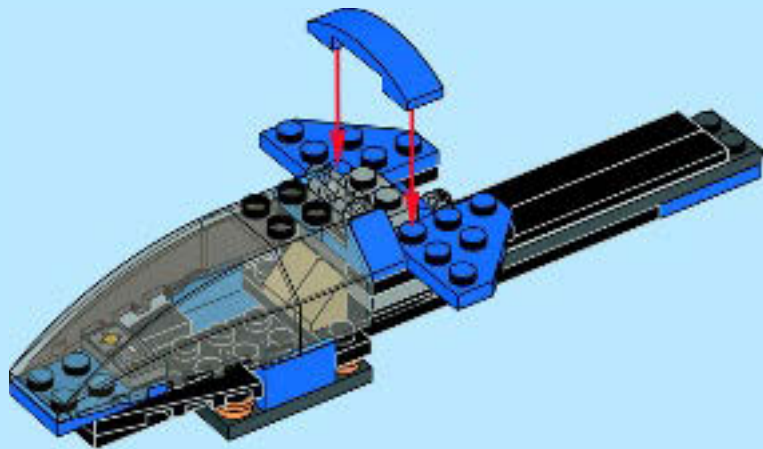

19

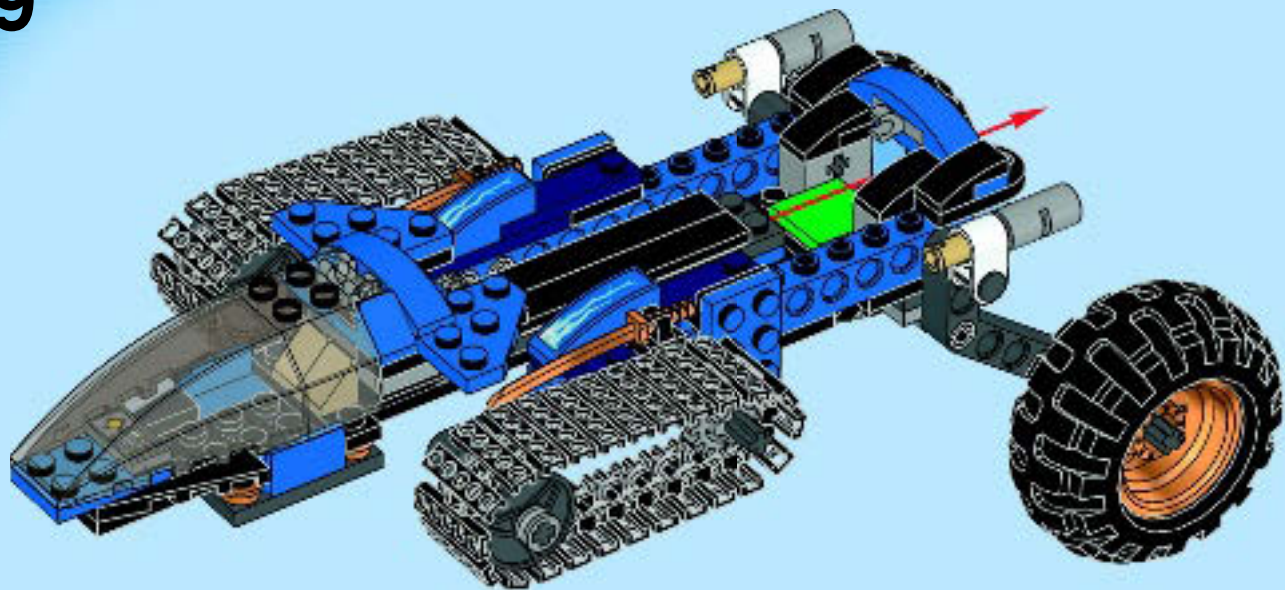



1x

20

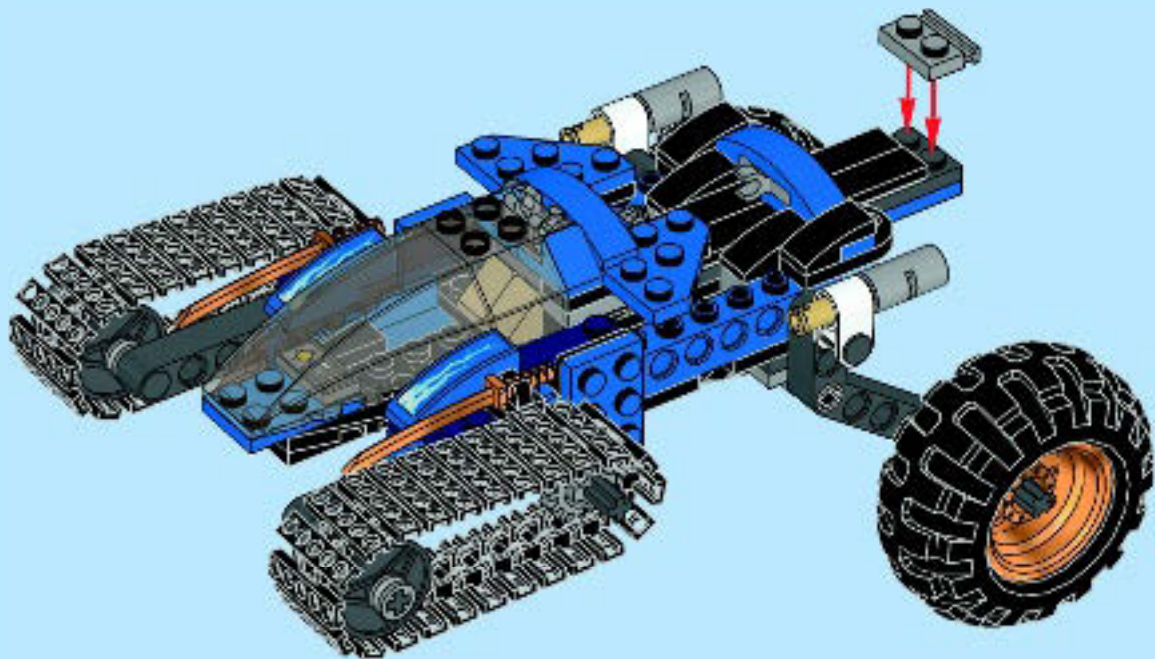



1x

# 21

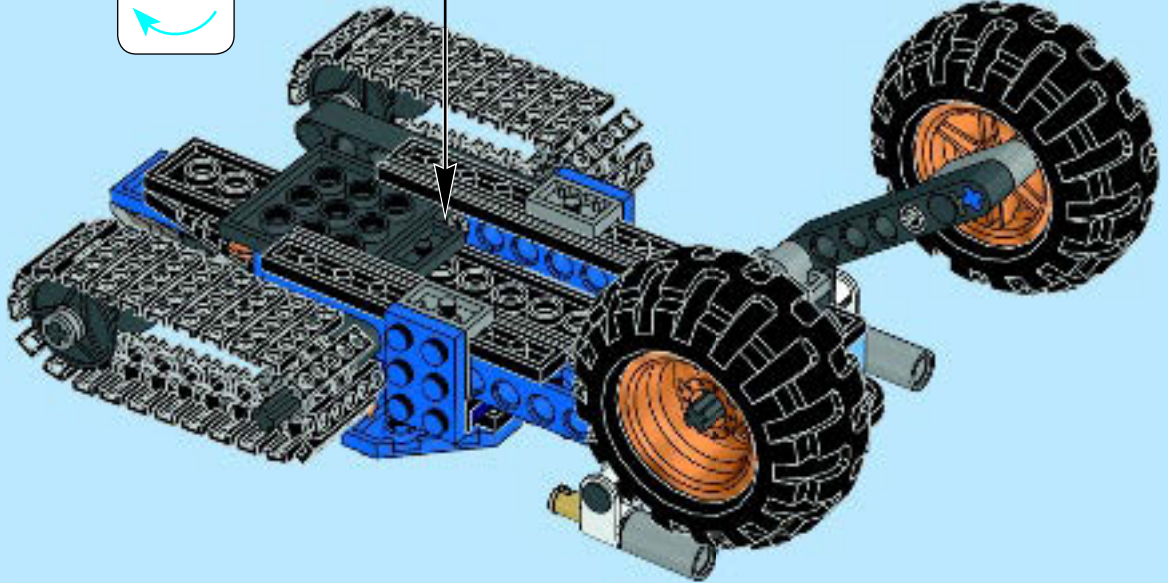
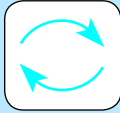



22

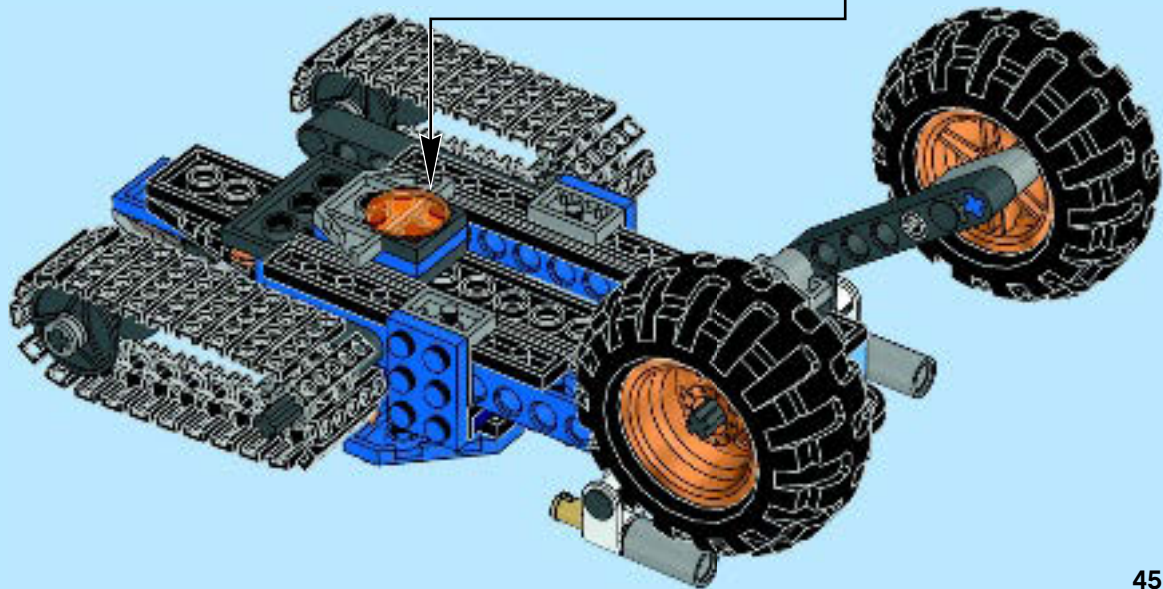



1

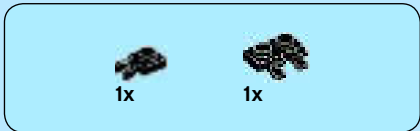

2



3

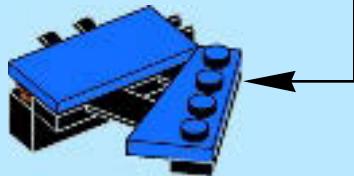
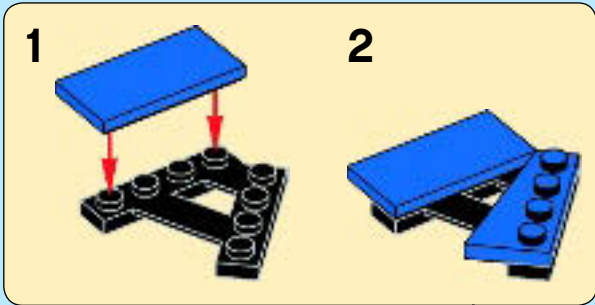



2x



2x



2x



2x

# 4

1



2



2x

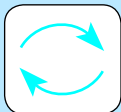

1x



1x

# 5

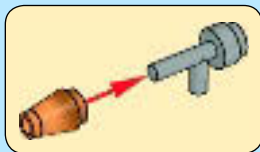

23

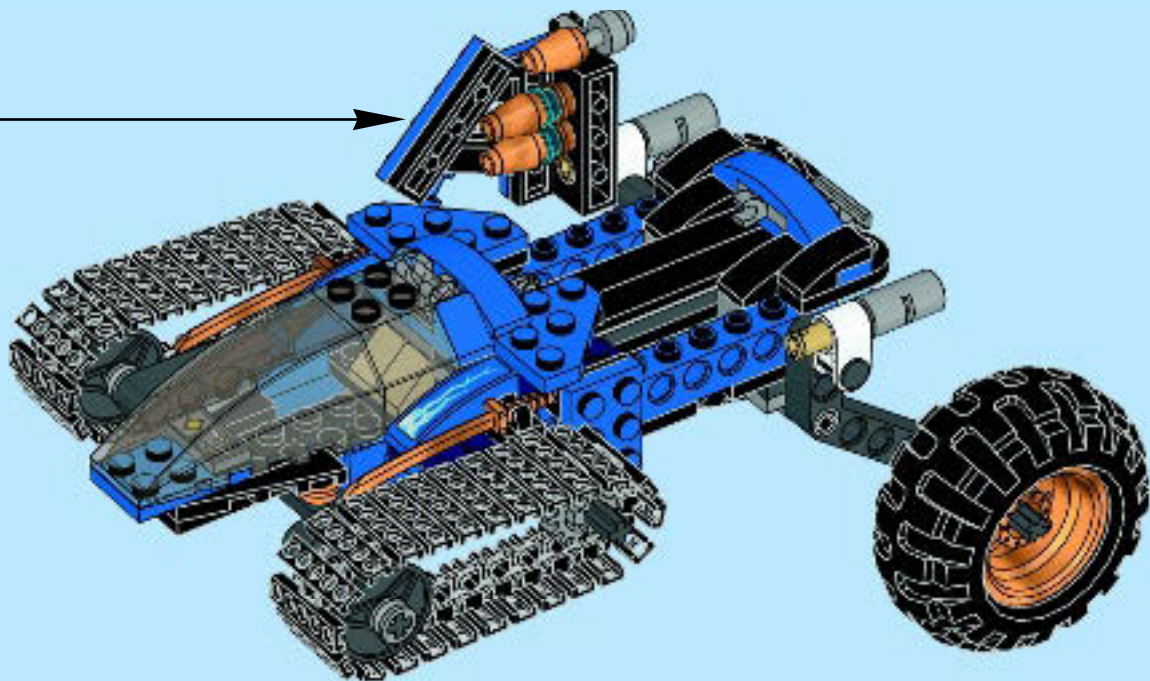
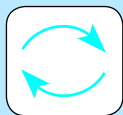





1

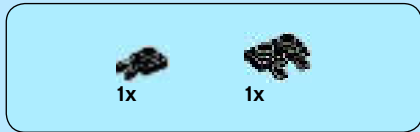

2

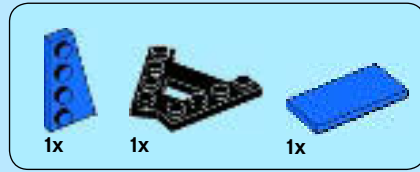

3

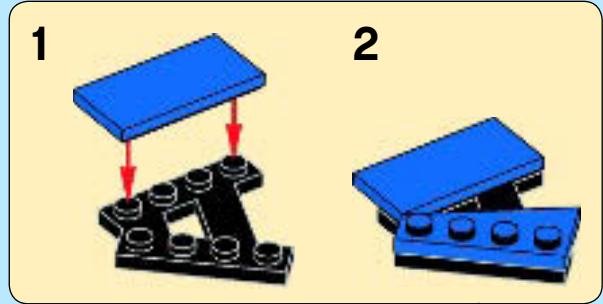

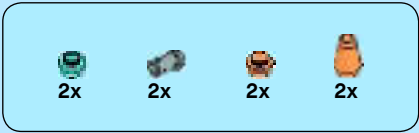

4

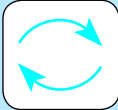

5

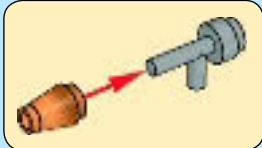

24

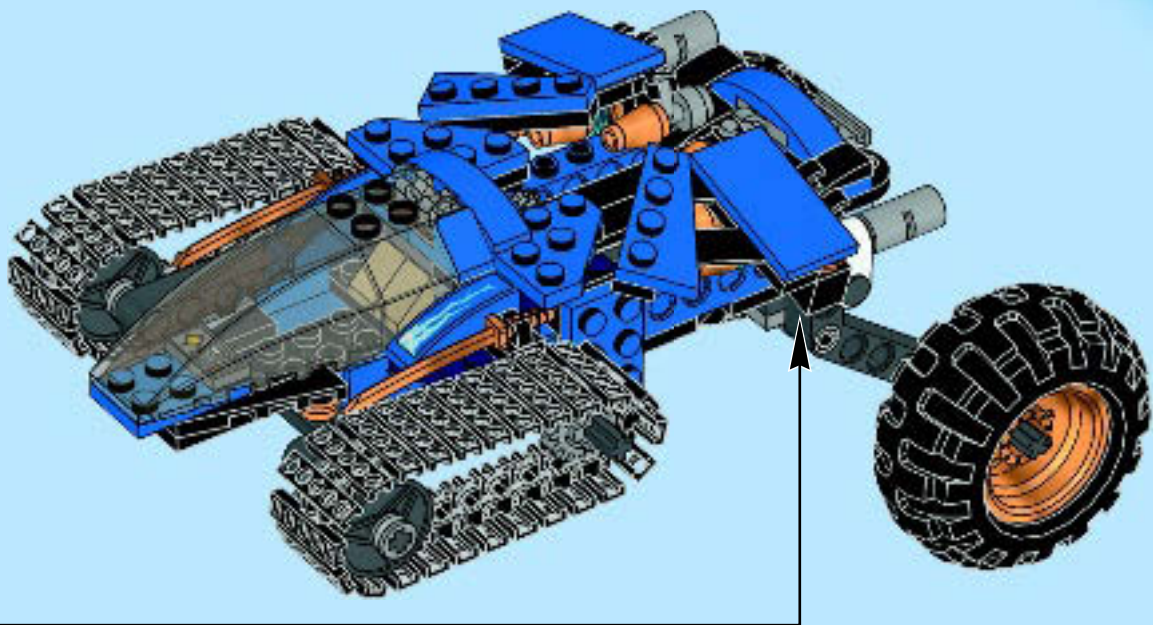





2x  
6031821

2x  
6036240

2x  
4613335

1x  
4652205

1x  
4616578

1x  
4278409

1x  
4579690

1x  
4211247

1x  
4211395

2x  
6028812

2x  
6028324

1x  
4515341

2x  
4598526

2x  
4654580

1x  
4654582

1x  
4211568

2x  
4233493

2x  
4211655

4x  
4211573

4x  
4211483

2x  
4211622

2x  
4278756

2x  
6045988

1x  
4507056

4x  
4550170

2x  
4595836

2x  
4644102

2x  
4526985

2x  
4211865

2x  
4640536

2x  
4211000

7x  
4211063

2x  
4497253

4x  
4211096

6x  
6048854

2x  
4239891

2x  
4620079

3x  
4211043

1x  
4243831

1x  
4211002

1x  
4210997

1x  
4210678

2x  
4495931

2x  
4281516

1x  
6057884

1x  
4221879

2x  
4210665

8x  
4560177

1x  
6030534

1x  
6046940

1x  
6020990

1x  
4107762

11x  
4523159

6x  
4529247

1x  
4655309

2x  
6003147

2x  
4624197

2x  
4648531

2x  
4614404

4x  
4646843

1x  
4598530



**Customer Service**  
Kundenservice  
Service Consommateurs  
Servicio Al Consumidor  
[LEGO.com/service](http://LEGO.com/service) or dial

00800 5346 5555 :       
1-800-422-5346 :  





# NINJAGO

Masters of Spinjitzu







# NINJAGO

Masters of Spinjitzu

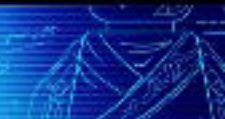



# NINJAGO

Masters of Spinjitzu



**LLOYD**  
70722 / 70725



**KAI**  
70721



**JAY**  
70723



**COLE**  
70720 / 70723



**ZANE**  
70724



**SENSEI GARMADON**  
70728



**BYL WU**  
MAY EP'ISODI WU  
MAY VADO WU  
70725



**GENERAL CRYPTOR**  
GENERAL CRYPTOR  
70721 / 70725



**NINDROID**  
70720 / 70724



**CYRUS BORG**  
70722



**NINDROID**  
70723 / 70724 / 70725



**PIXAL**  
70724



# NINJAGO

Masters of Spinjitzu



[LEGO.COM/NINJAGO](http://LEGO.COM/NINJAGO)

GO ONLINE FIND OUT MORE

VA EN LIGNE POUR EN SAVOIR PLUS

MÁS INFORMACIÓN EN INTERNET



# WIN!

Go to [LEGO.com/productfeedback](http://LEGO.com/productfeedback) to fill out a survey for a chance to win a cool LEGO® Product.

No purchase necessary.  
Open to all residents where not prohibited.



## LEGO.com/productfeedback

### GEWINNE!

Nimm an der Umfrage auf [LEGO.com/productfeedback](http://LEGO.com/productfeedback) teil und hab die Chance ein cooles LEGO® Produkt zu gewinnen!

Die Teilnahme am Gewinnspiel führt zu keinerlei Kaufverpflichtungen. Teilnahme in allen nicht ausgeschlossenen Ländern möglich.

 [LEGO.com](http://LEGO.com)

6088070

### WIN!

Ga naar [LEGO.com/productfeedback](http://LEGO.com/productfeedback), vul een enquêteformulier in en maak kans op een cool LEGO® product.

Geen aankoopverplichting.  
Iedereen mag deelnemen, uitgezonderd ingezetenden van landen waar een enquêteverbod geldt.

### GAGNE!

Visite [LEGO.com/productfeedback](http://LEGO.com/productfeedback) pour répondre à un questionnaire et avoir une chance de gagner un produit LEGO® très cool!

Aucune obligation d'achat.  
Ouvert à tous les résidents des pays autorisés.

### 当てよう!

[LEGO.com/productfeedback](http://LEGO.com/productfeedback) にアクセスして、アンケートにご記入ください。当選者にはレゴ®製品を差し上げます。

お買い上げの必要はありません。  
禁止されていない限り、すべての皆様にご利用いただけます。

LEGO and the LEGO logo are trademarks of the/sont des marques de commerce de/  
son marcas registradas de LEGO Group. ©2014 The LEGO Group.