



# THE HOBBIT

THE RESCUSSION OF SHALIN

79011



1



2



3



4



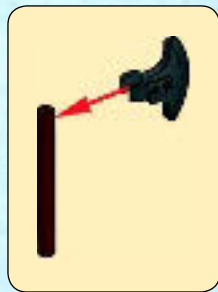
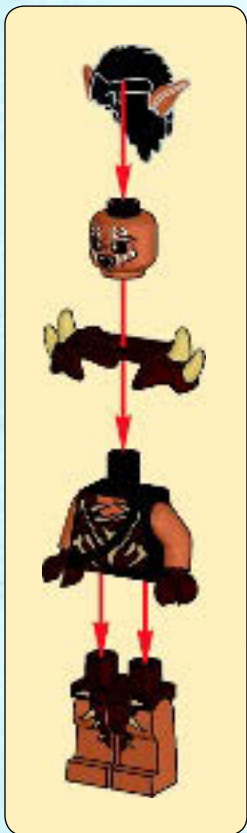



1

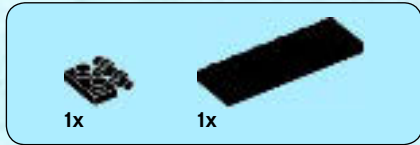

2

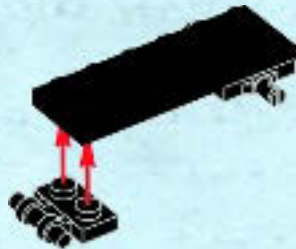



1x



2x

3



1x



2x

4

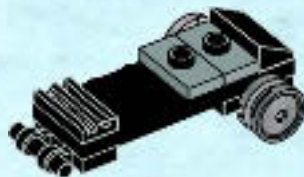



1x

5



6



1x



1x

6

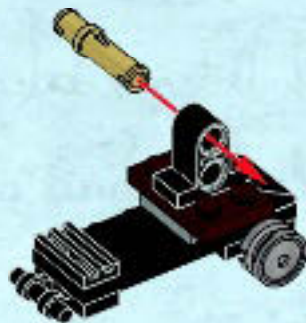



2x

7



3x

8





1

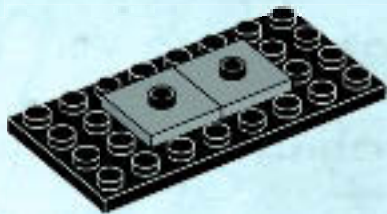





1x



3x

2

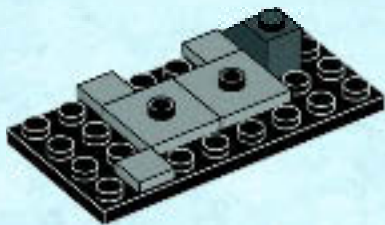

2x



1x

3

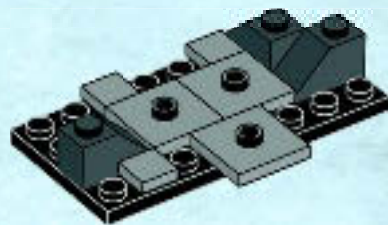

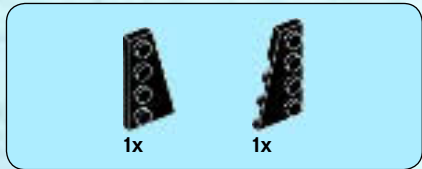

4

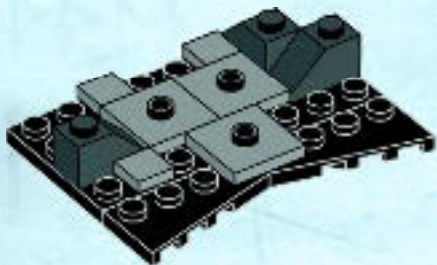

5

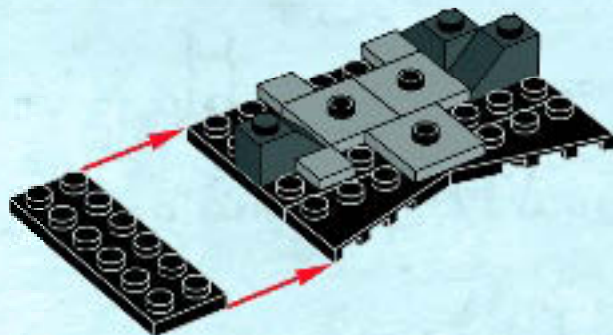

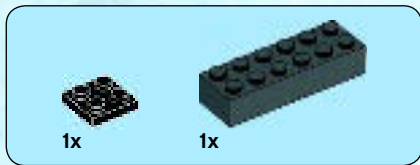

6

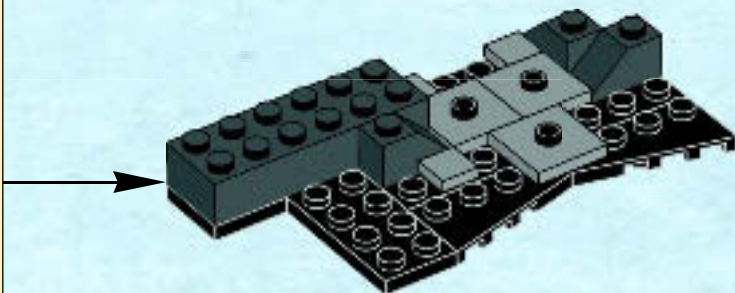
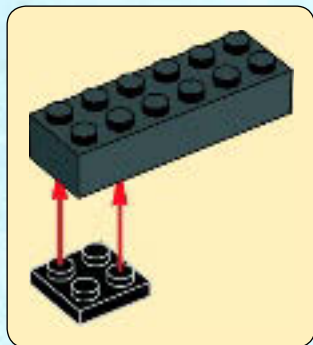



1x

7

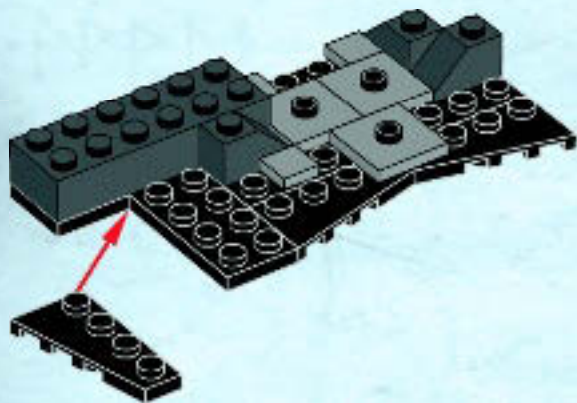

12



1x



1x

8

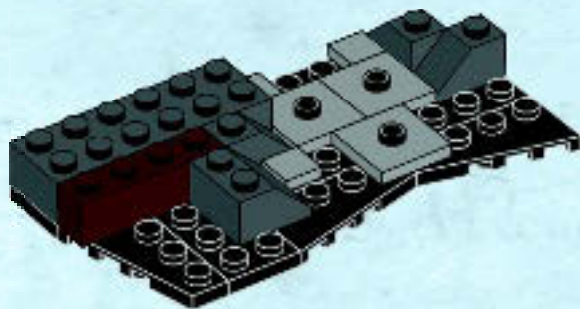



1x



1x



1x

# 9

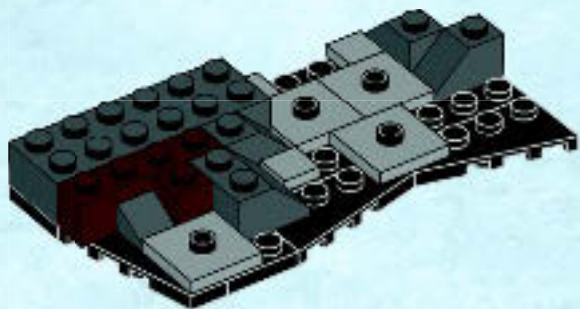

1x

# 10

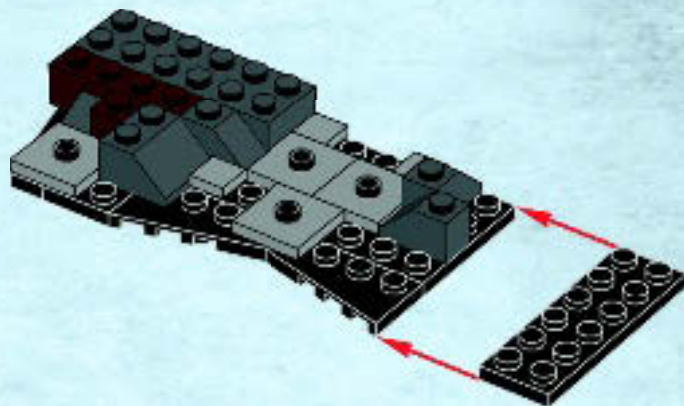

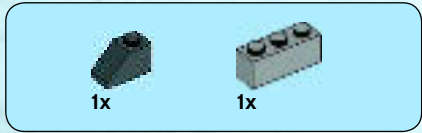

11

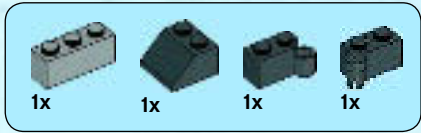
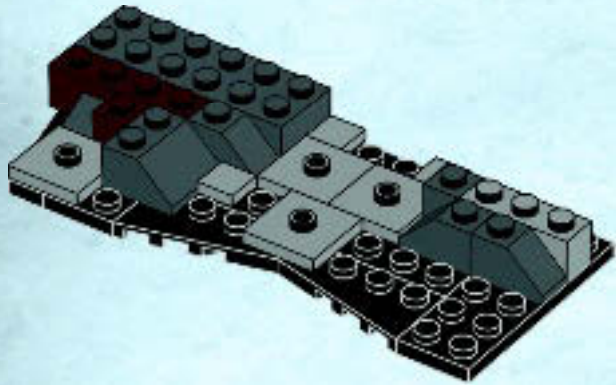

12

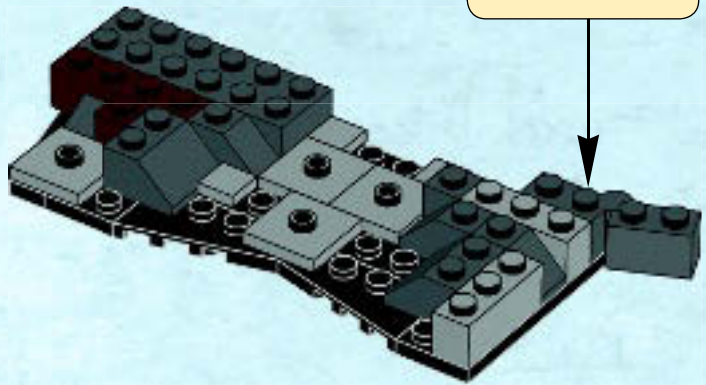
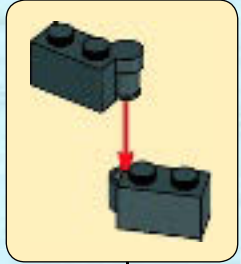



2x



1x



1x

# 13

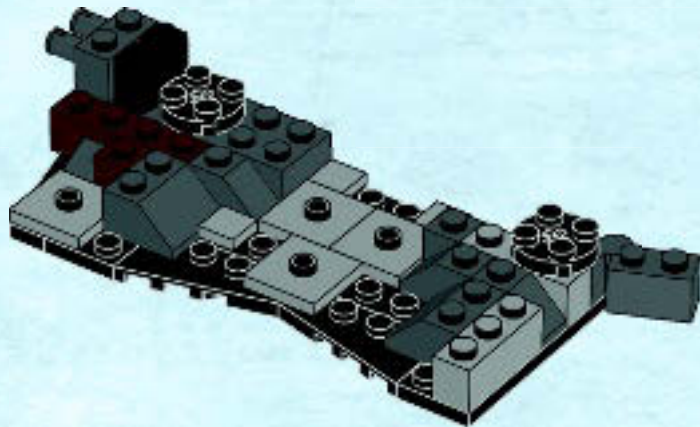

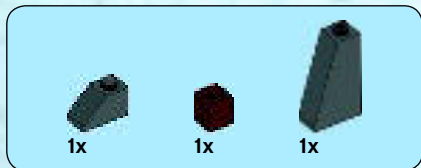

14

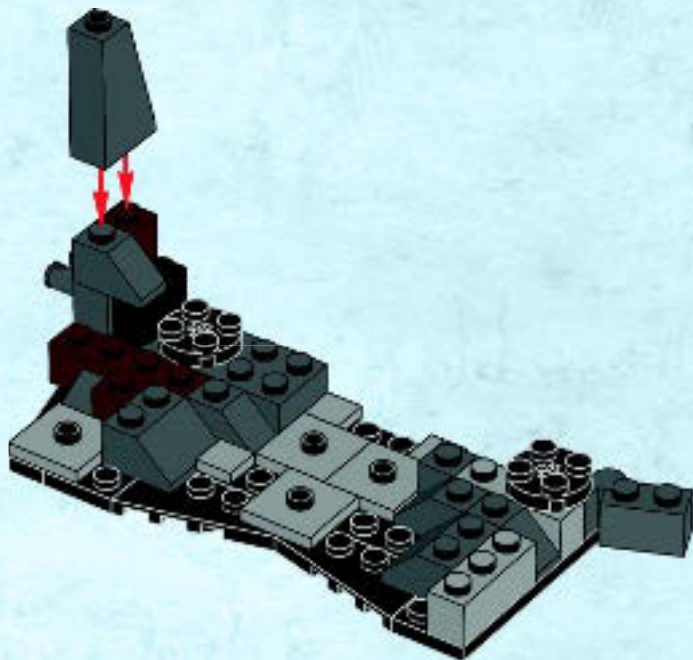



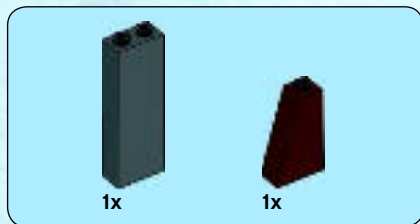

15

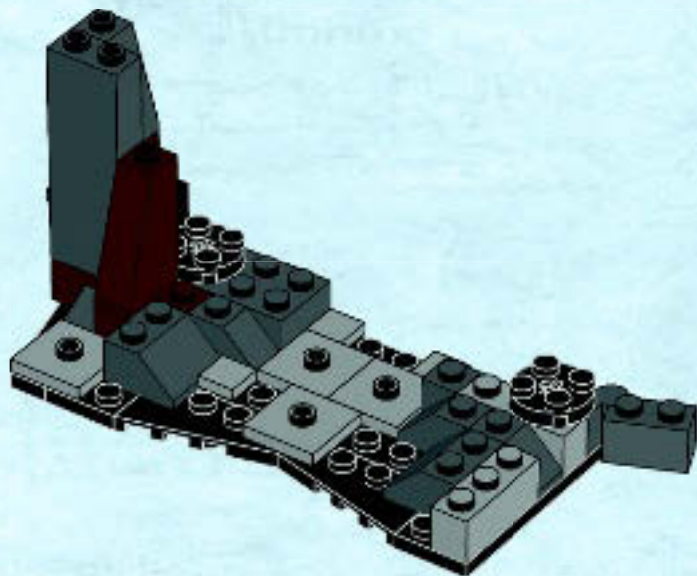



# 16

1



2



3



4



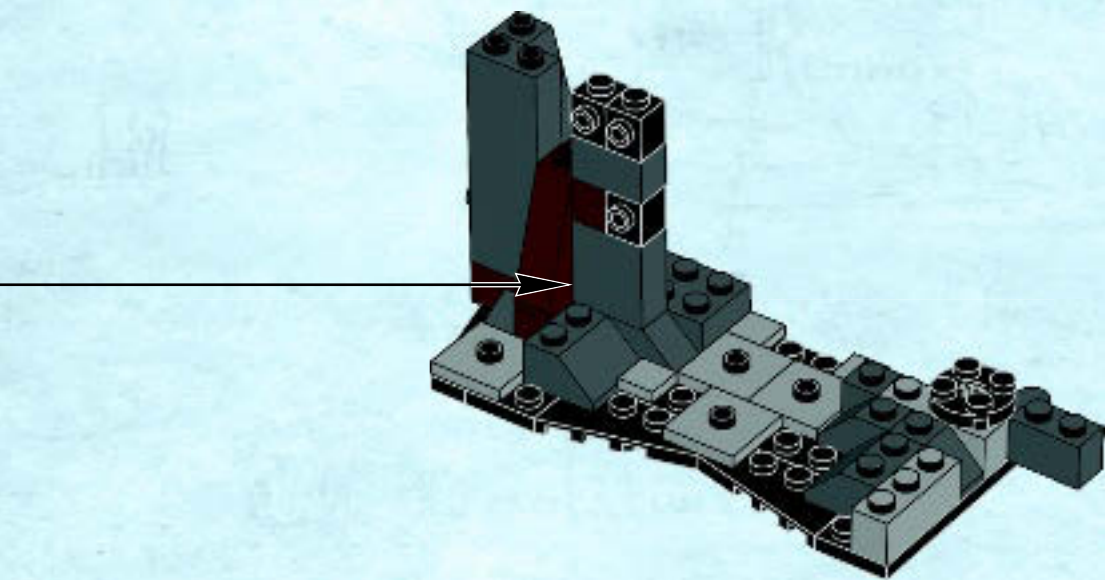

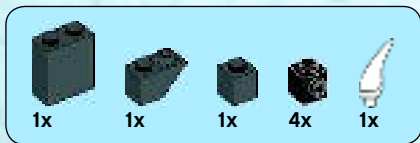

17

1



2

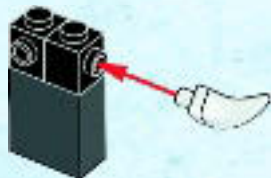

3

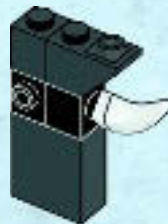

4



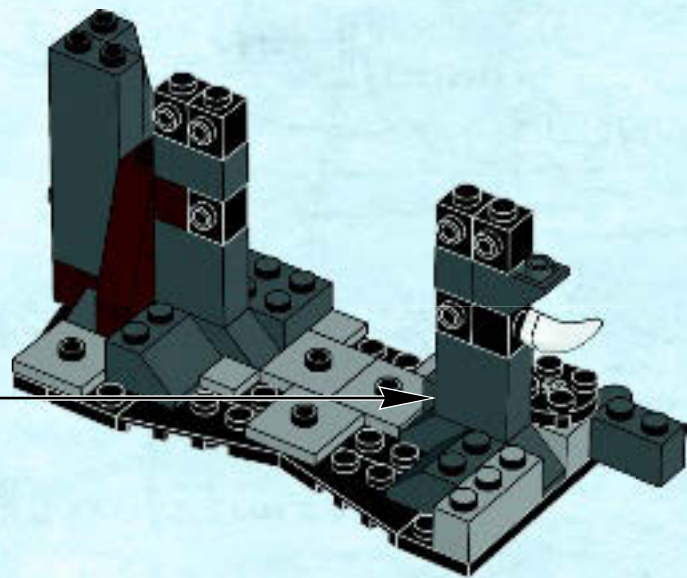



18

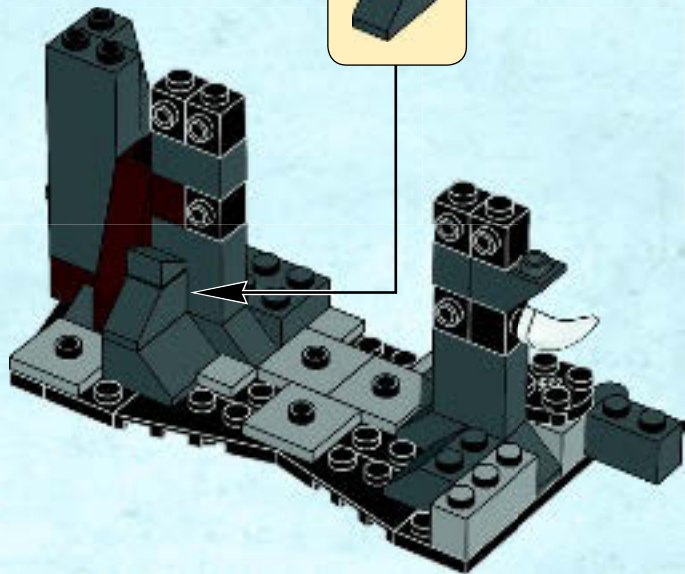
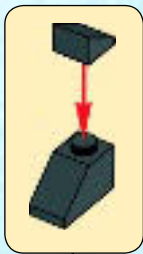

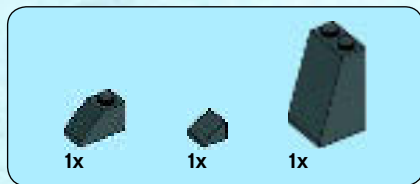

19

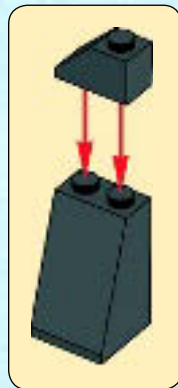
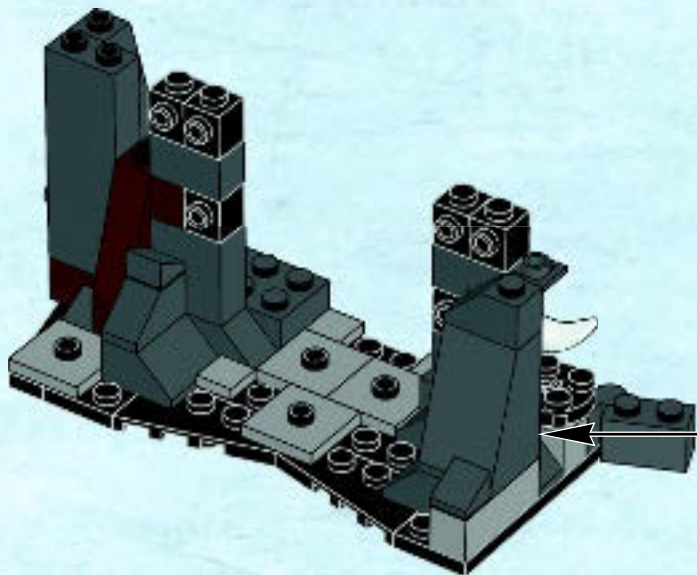

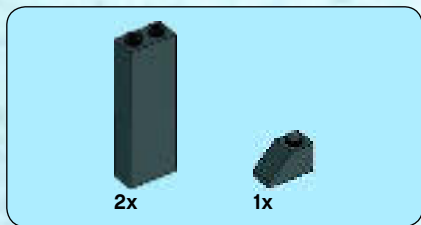

20

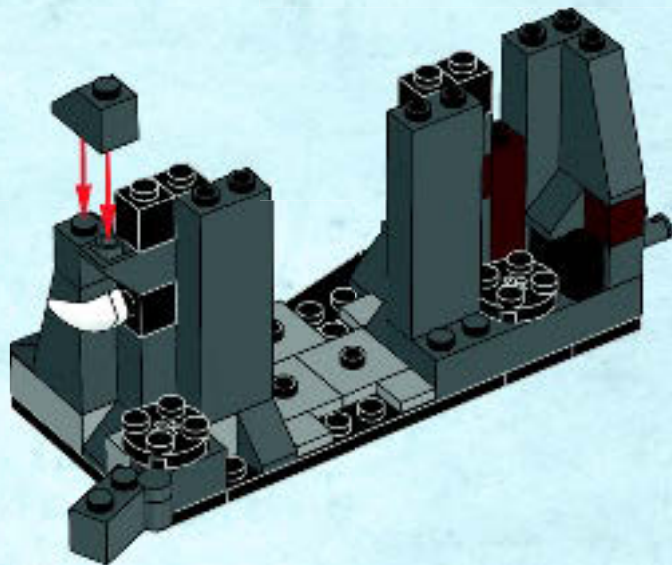
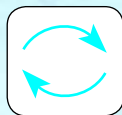



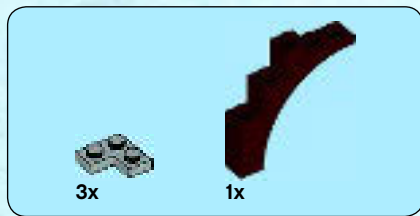

21

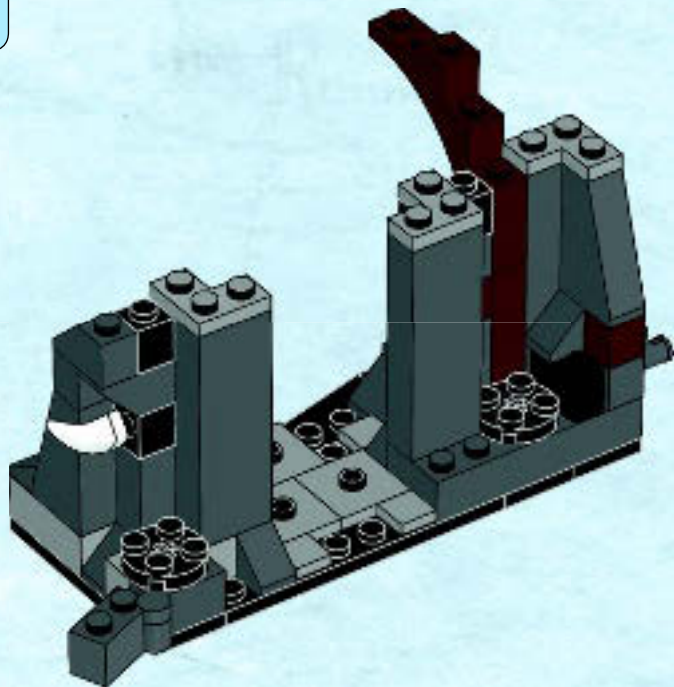

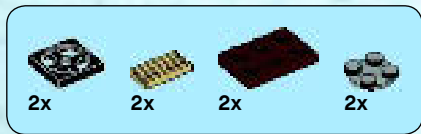

# 22

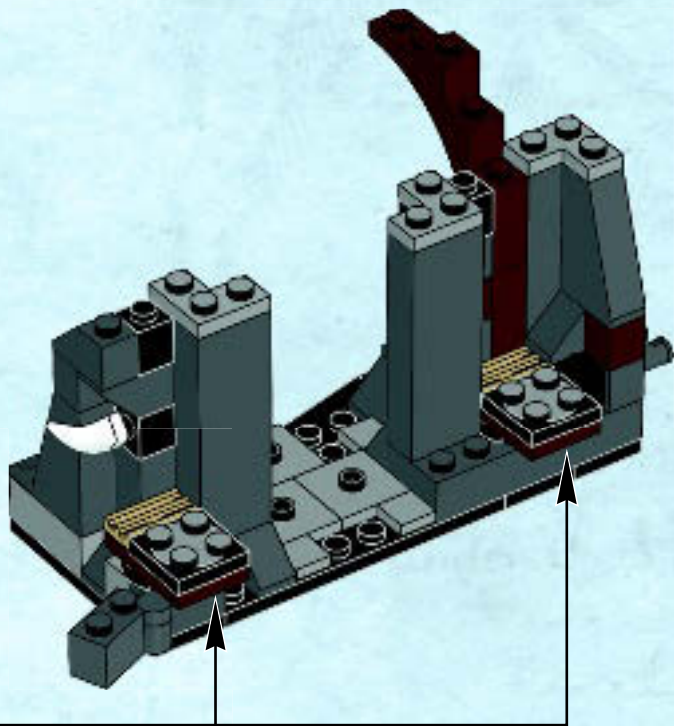
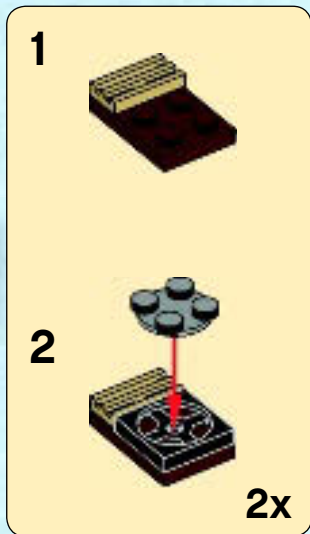

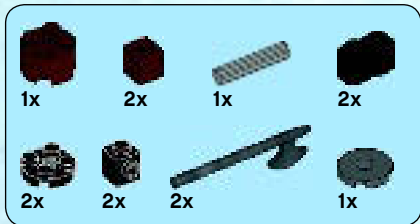

23

1



2



3



4



5



6



7

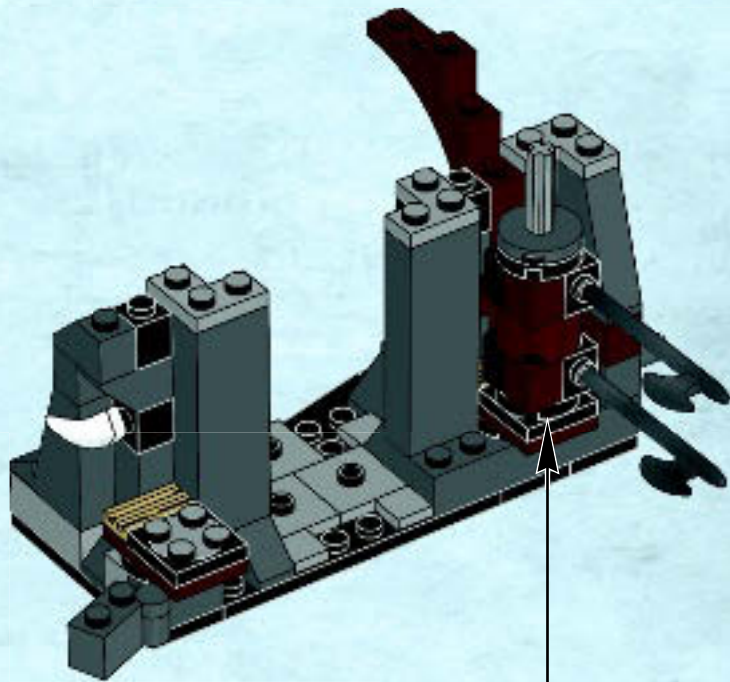

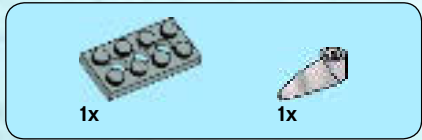

24

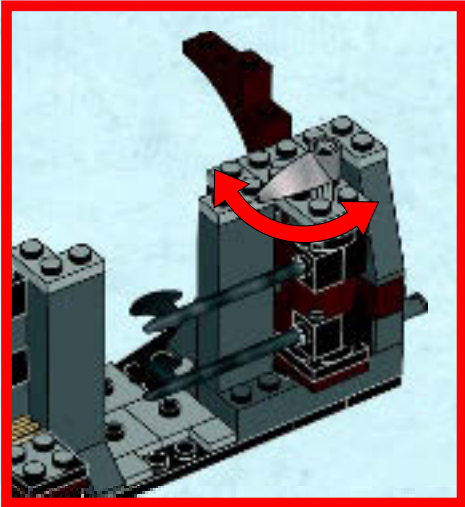
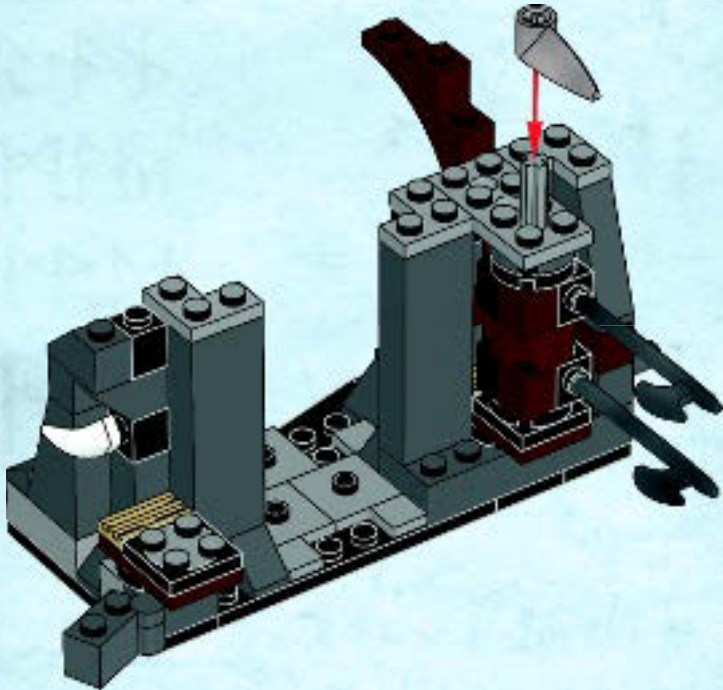

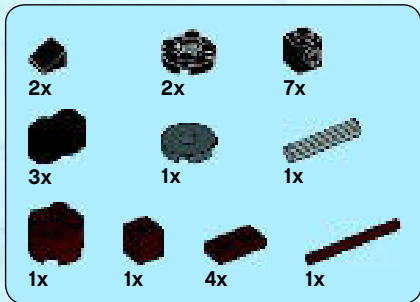

**25**

**1**



**2**



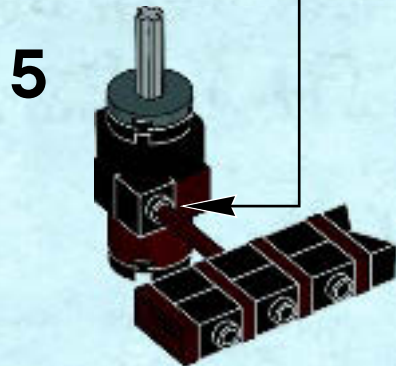
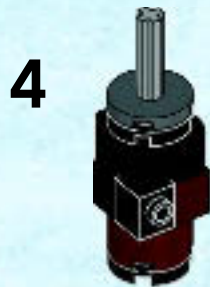
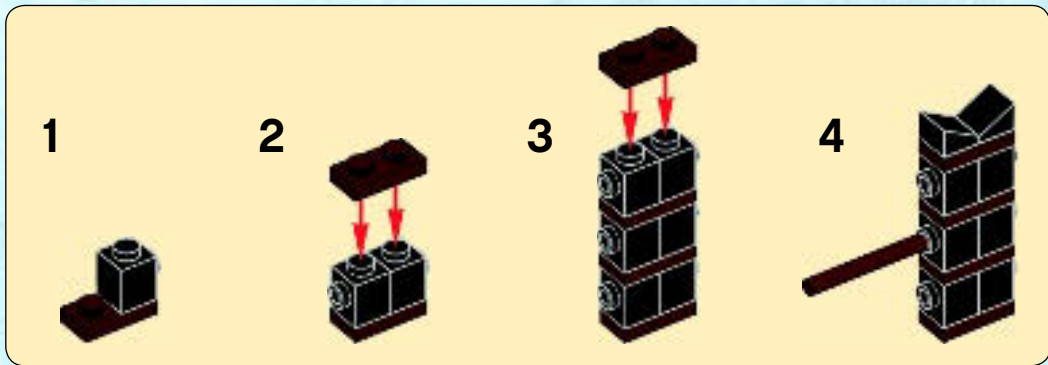



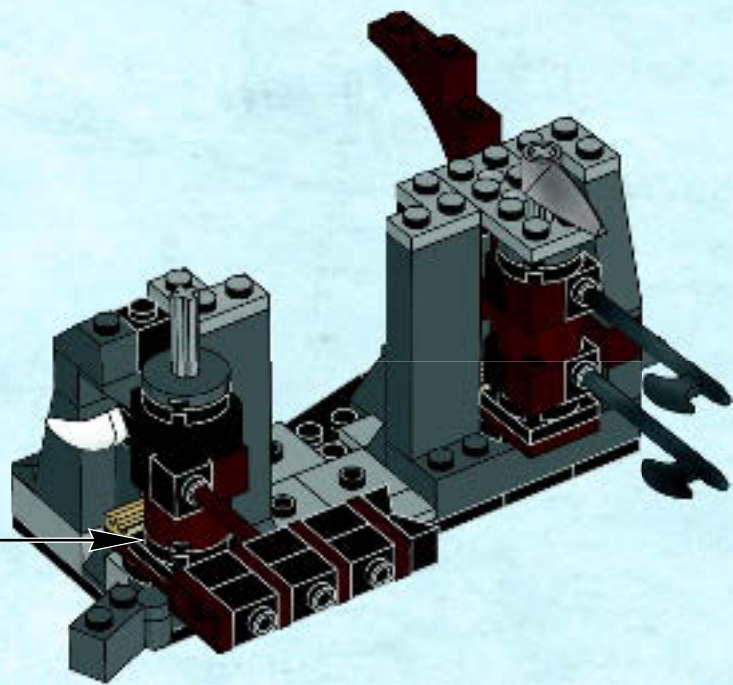

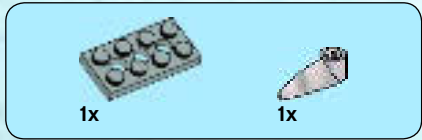

26

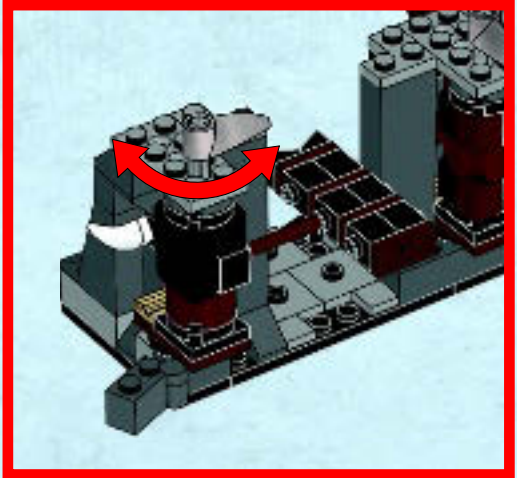
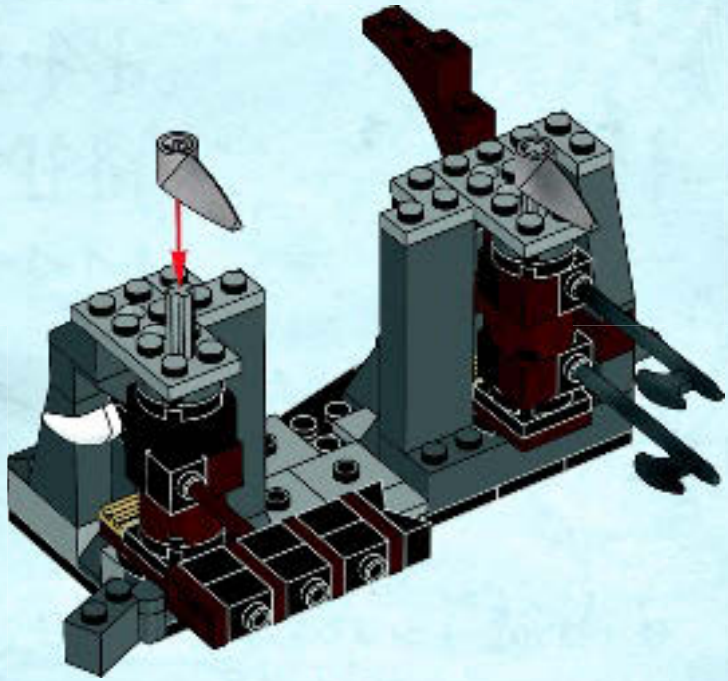



1x



2x

27

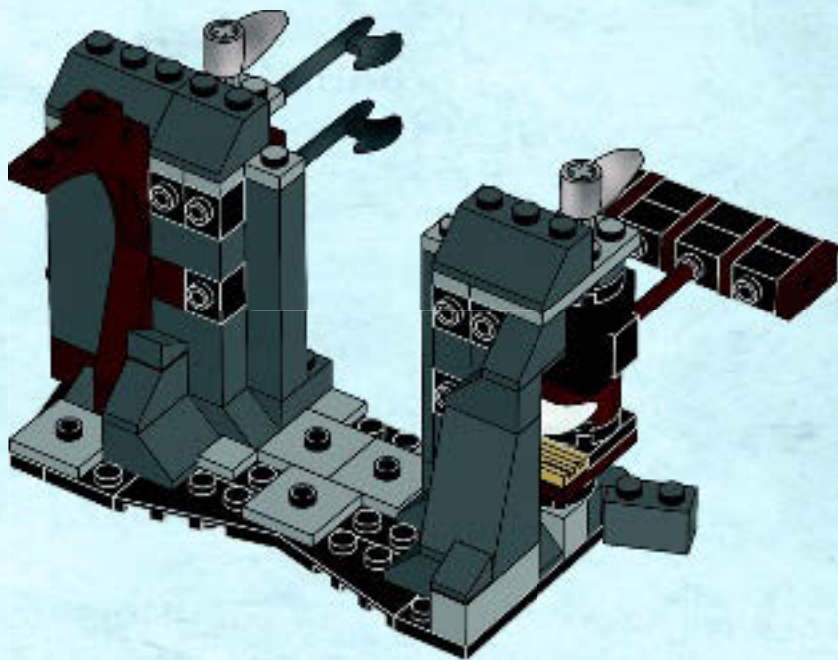
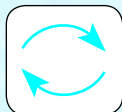



2x



2x



1x

# 28

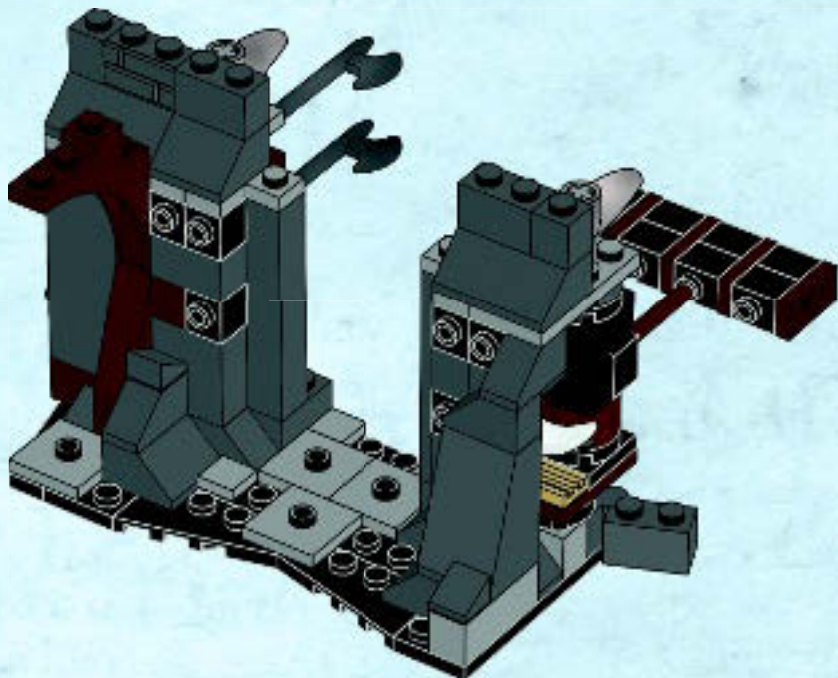



4x



2x

# 29

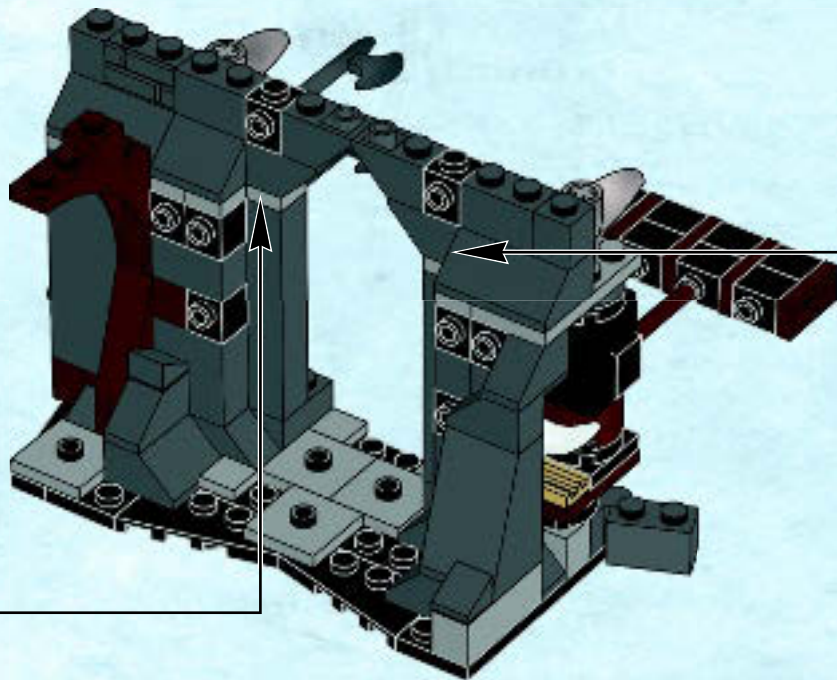

1



2



1



2





30

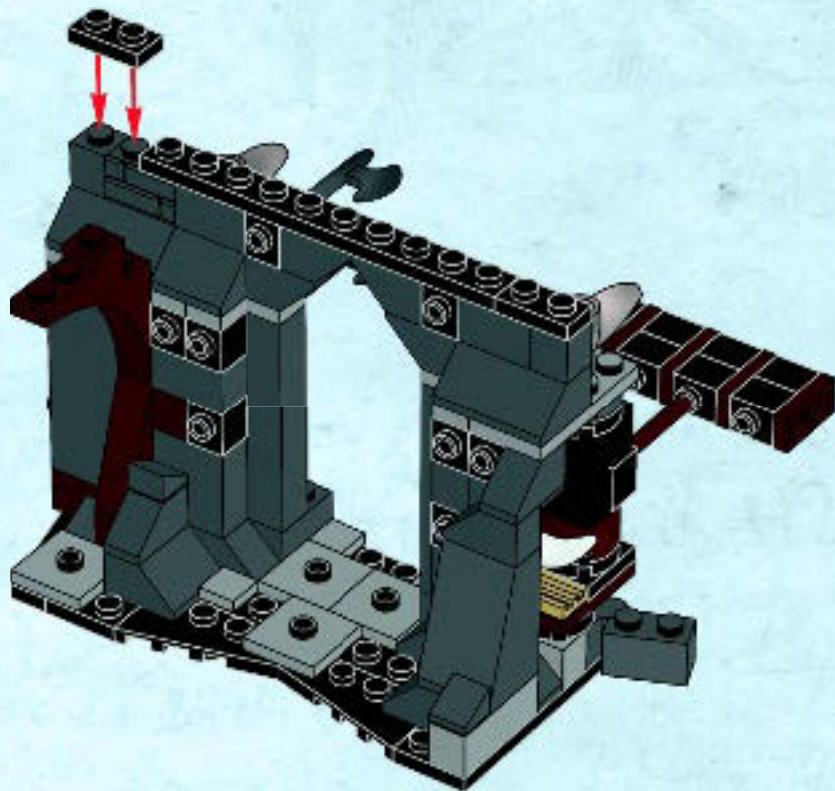



4x



4x

# 31



2x

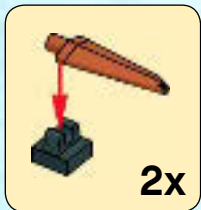

2x

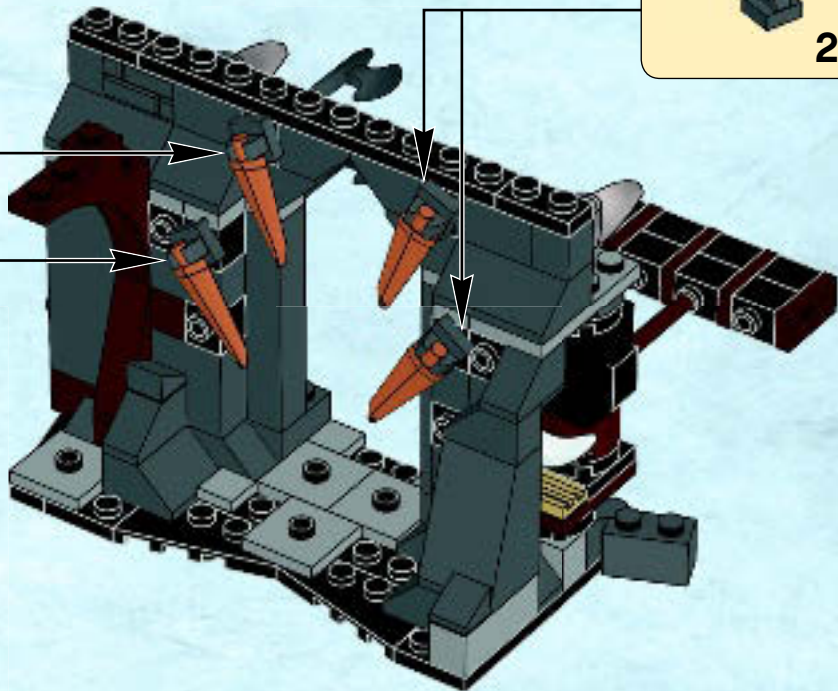



1x



2x



1x



1x

# 32

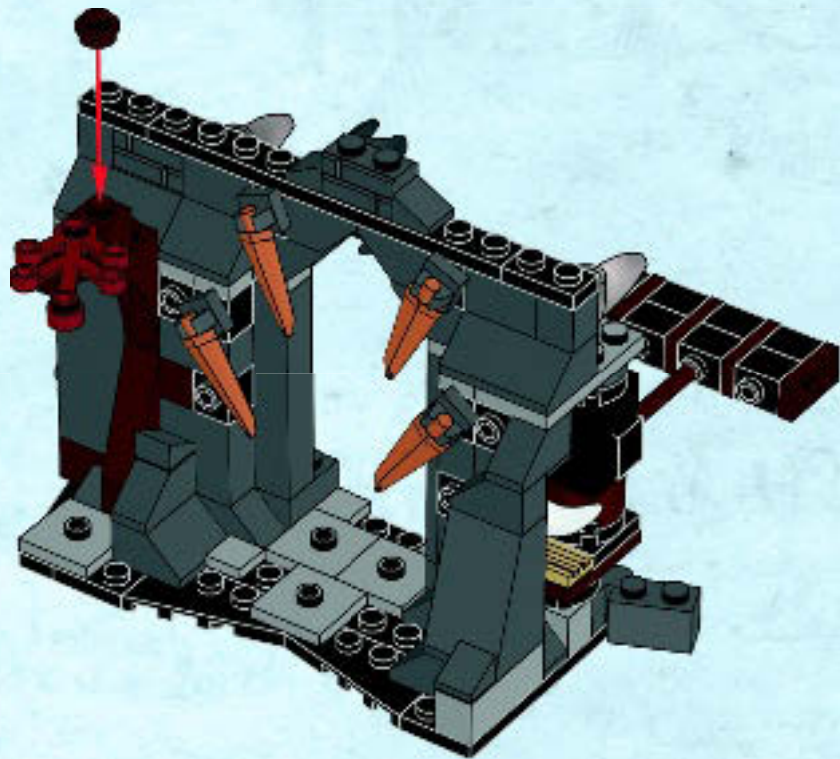





33

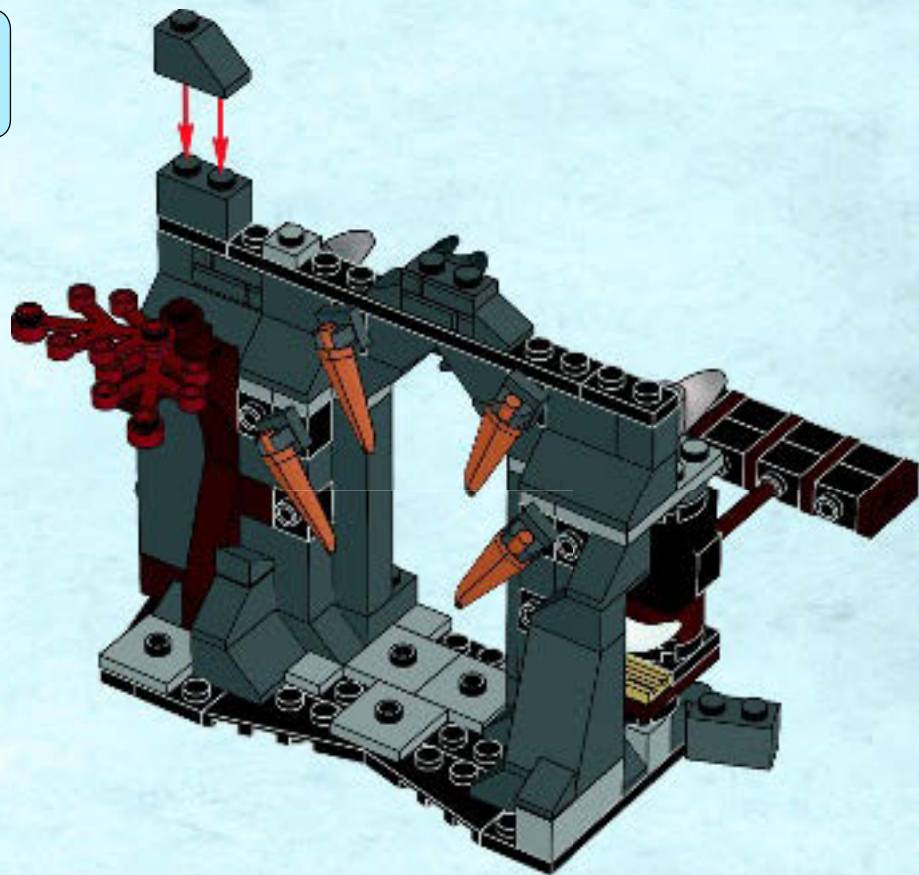



1x



5x

# 34

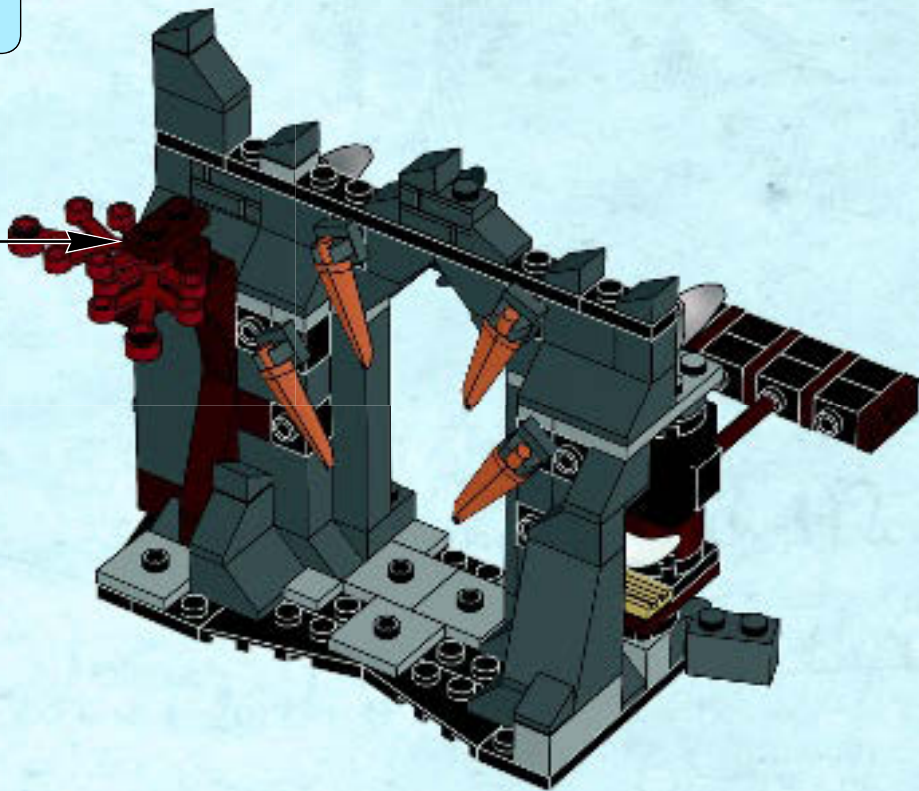

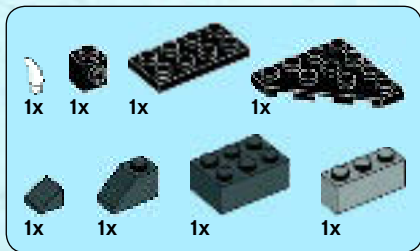

**35**

**1**



**2**

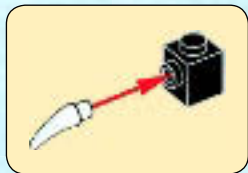

**3**

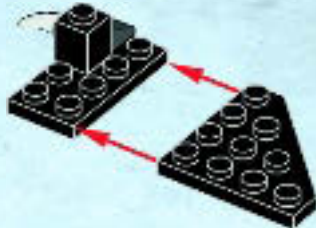

4

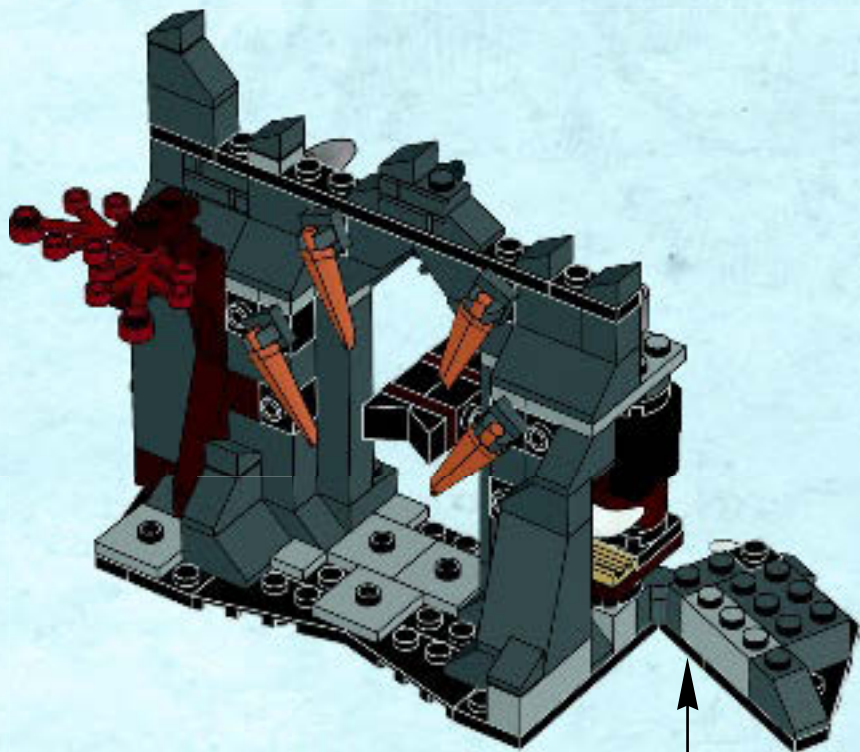



1x



1x

# 36

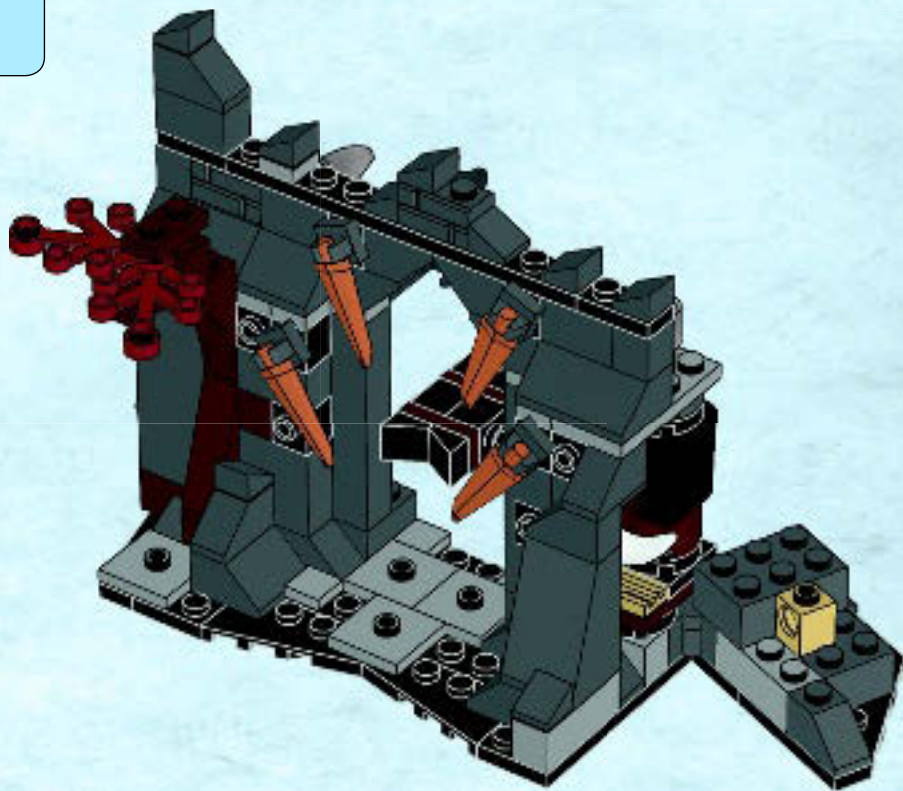



37

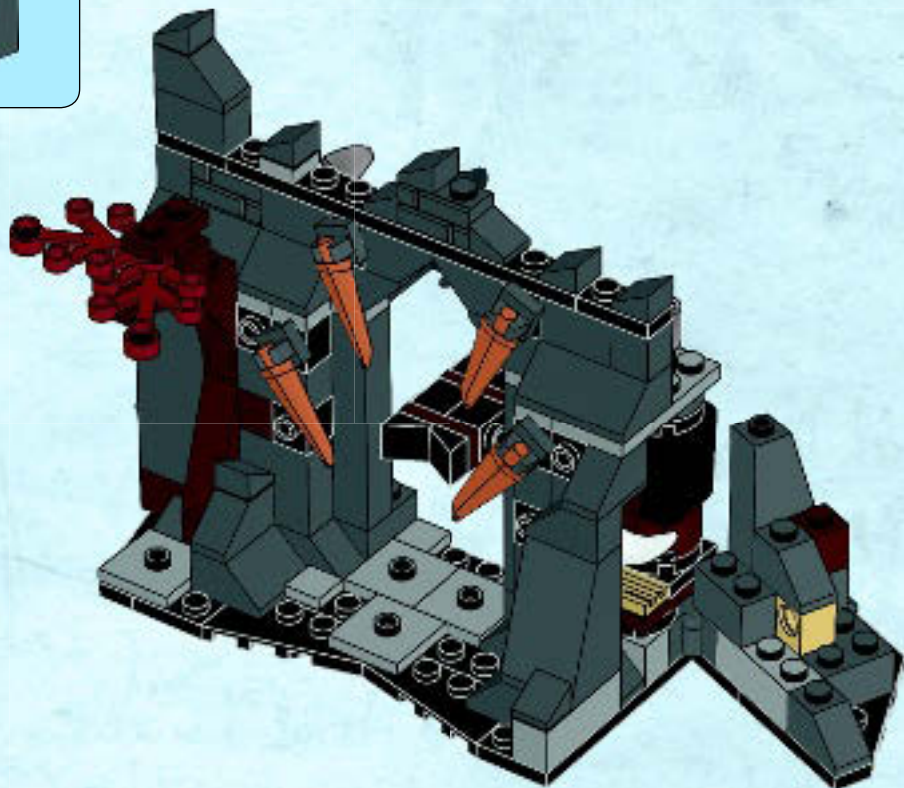

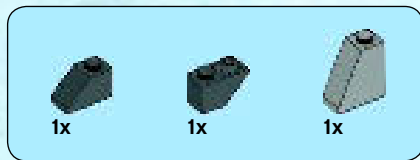

38

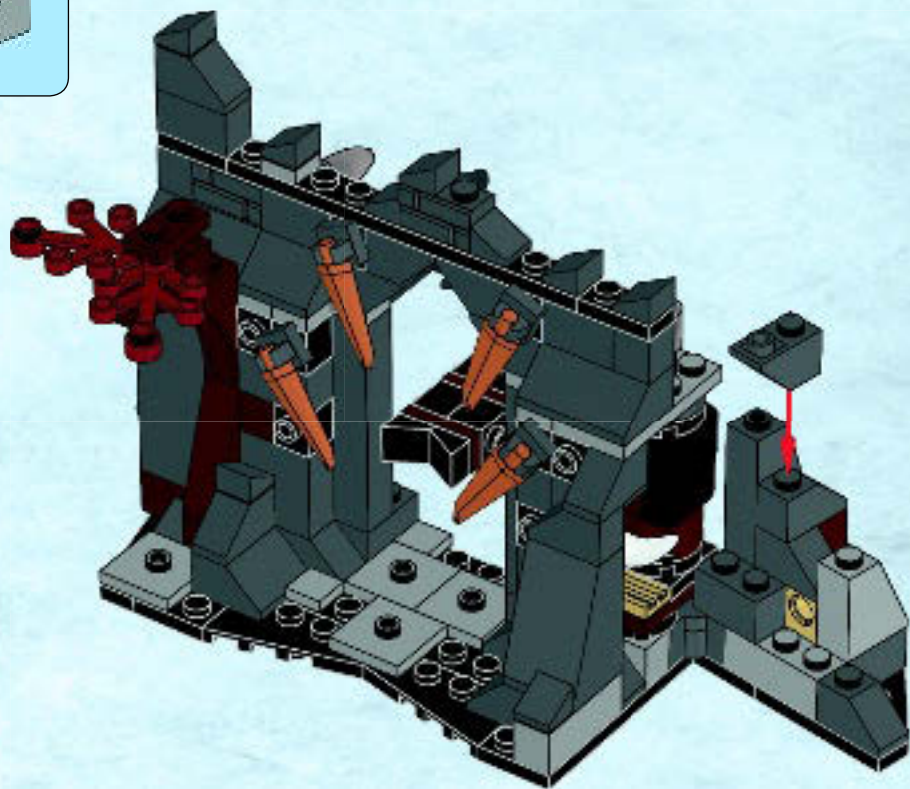



39

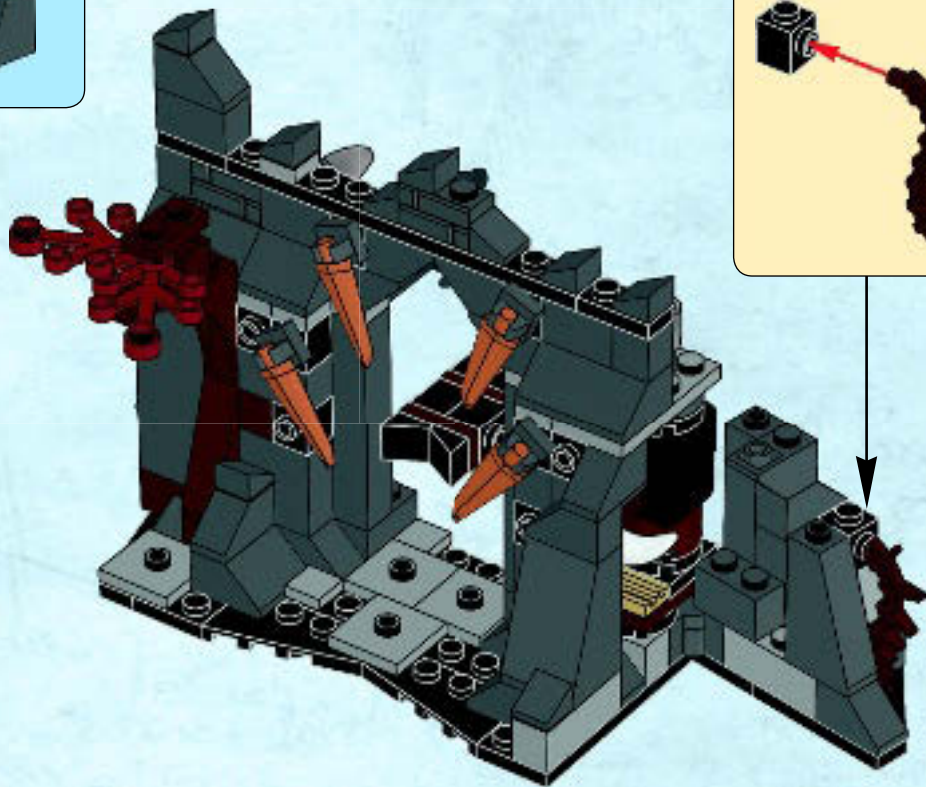





2x

40

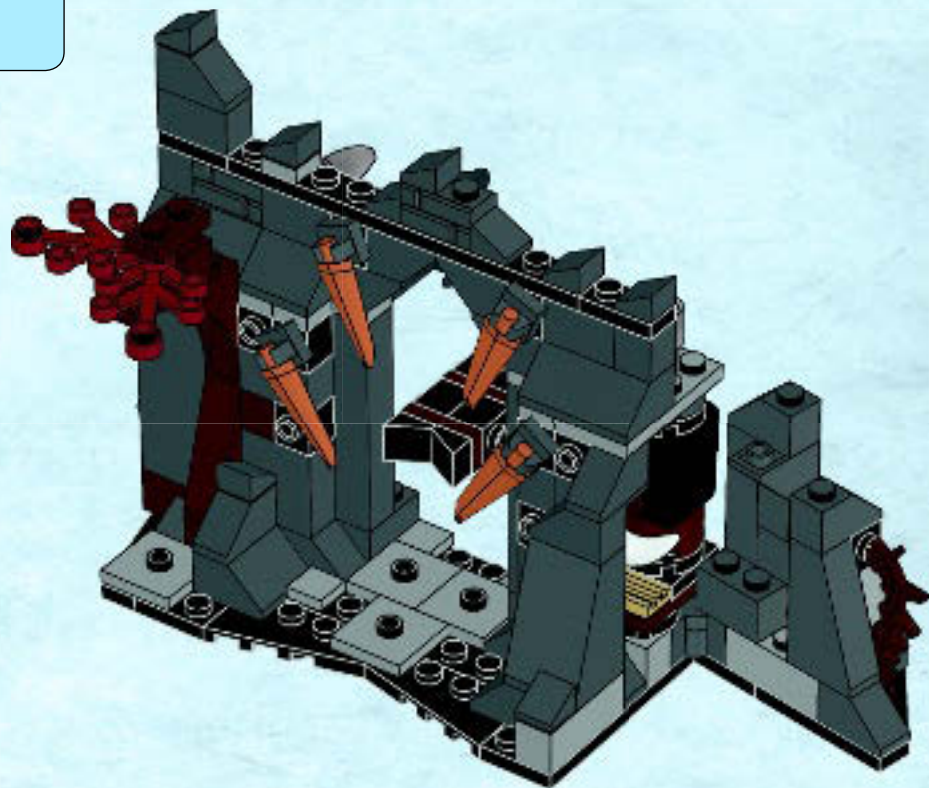



1x

41

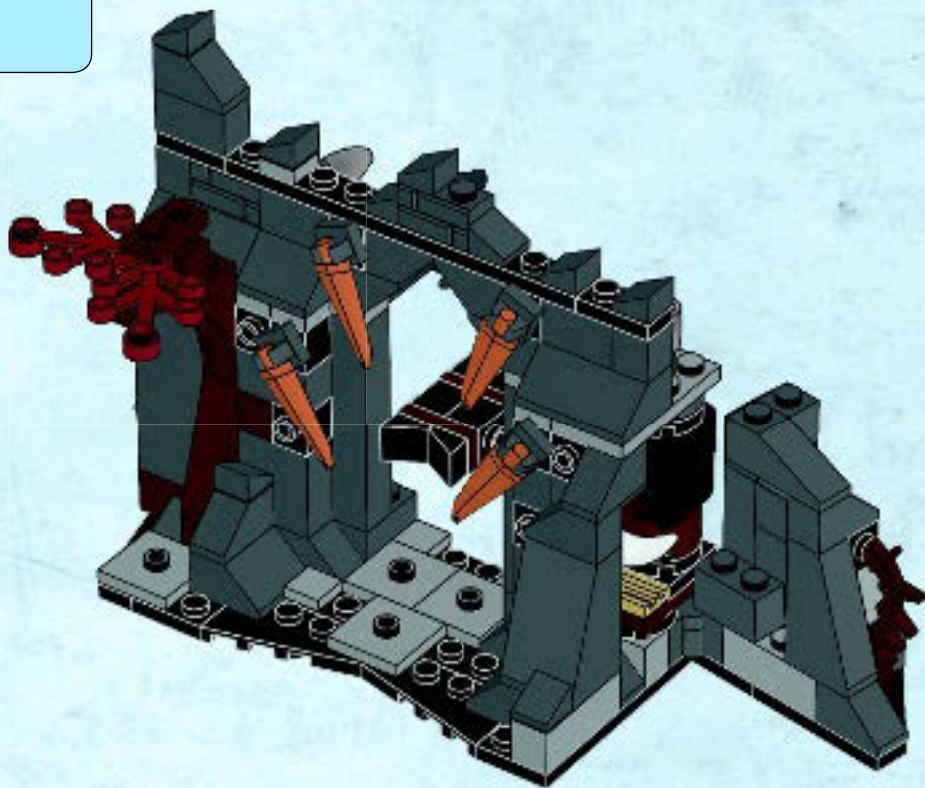



# 42

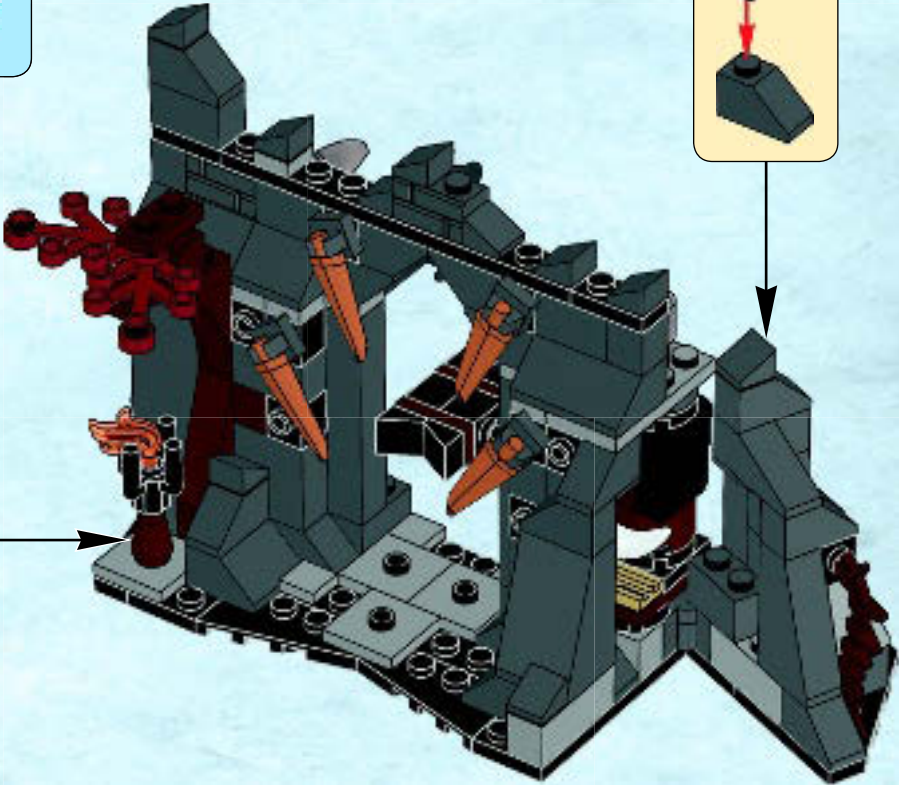
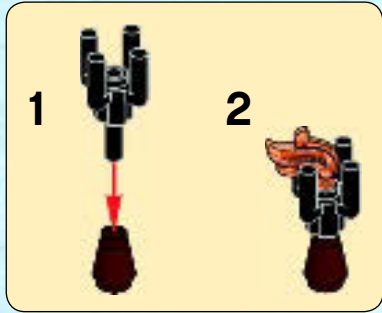
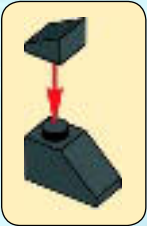

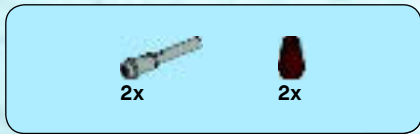

# 43

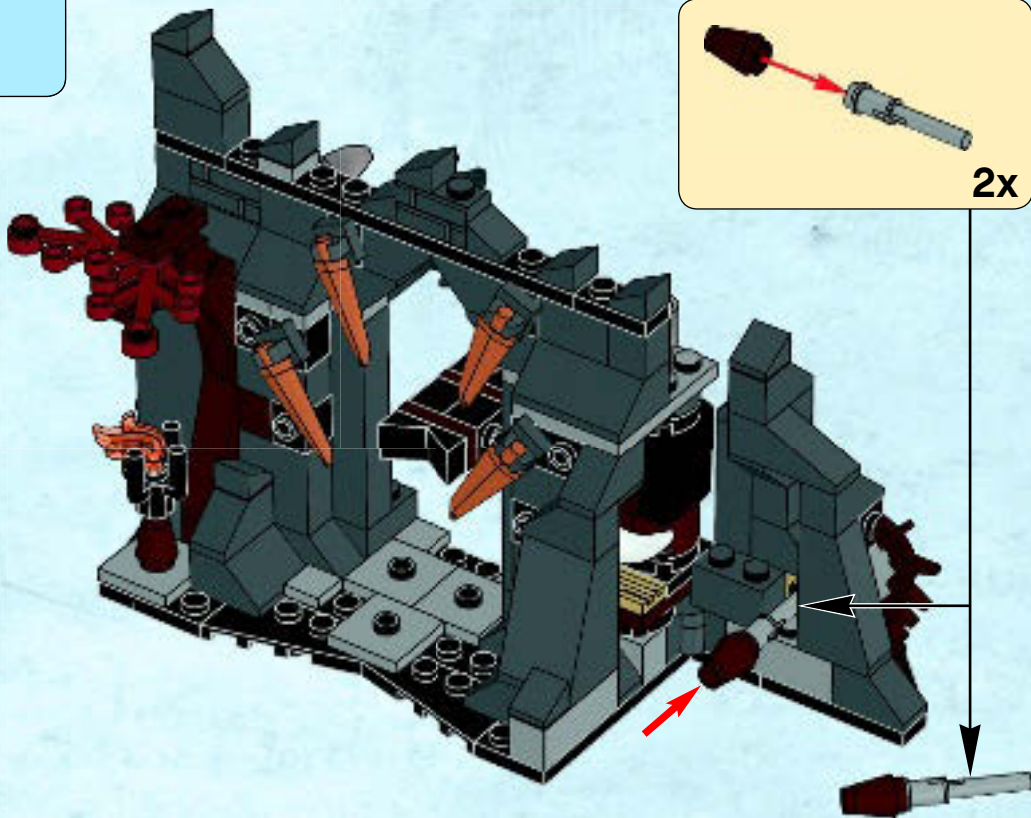

1

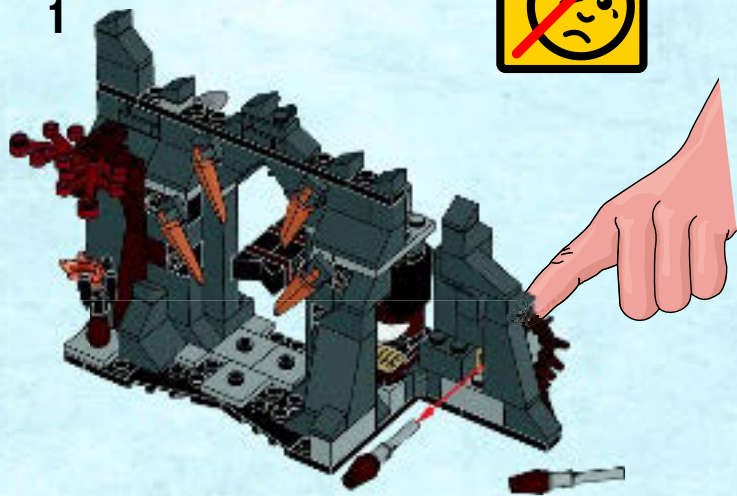

2

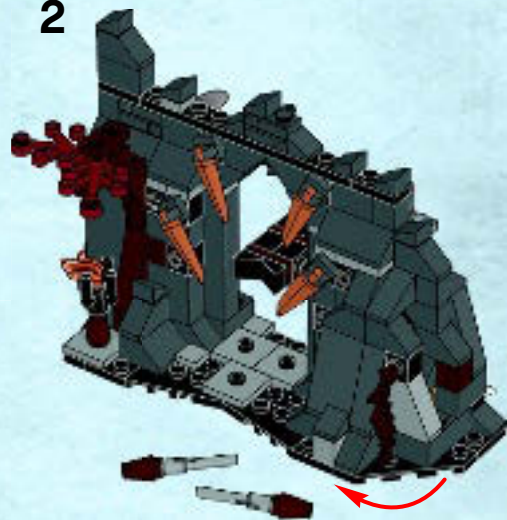



2x

44





Customer Service

Kundenservice

Service Consommateurs

Servicio Al Consumidor

LEGO.com/service or dial



: 00800 5346 5555

: 1-800-422-5346

79014



79014



+

79011

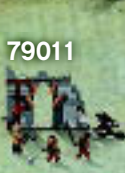

=









□ 79011  
Beorn™



□ 79011  
Gundabad Orc  
Orque de Gundabad  
Orco de Gundabad



□ 79014  
Azog™



□ 79012  
Gundabad Orc  
Orque de Gundabad  
Orco de Gundabad



□ 79012  
Thranduil



□ 79013  
Bilbo Baggins™



□ 79013  
Bard the Bowman™



□ 79012  
Gundabad Orc  
Orque de Gundabad  
Orco de Gundabad



□ 79012  
Mirkwood™ Elf Archer  
Elfe archer de Mirkwood™  
Elfo Arquero de Mirkwood™



□ 79013  
Master of Lake-town  
Maître de Lacville  
Maestro de Ciudad del Lago



□ 79014  
Gandalf™ the Grey  
Gandalf™ le Gris  
Gandalf™ el Gris



□ 79014  
Gundabad Orc  
Orque de Gundabad  
Orco de Gundabad



□ 30216  
Lake-town Guard  
Garde de Lacville  
Guarda de Ciudad del Lago



□ 79012  
Mirkwood™ Elf Archer  
Elfe archer de Mirkwood™  
Elfo Arquero de Mirkwood™



□ 79014  
Gundabad Orc  
Orque de Gundabad  
Orco de Gundabad



□ 79011  
Gundabad Orc  
Orque de Gundabad  
Orco de Gundabad



□ 79013  
Thorin Oakenshield™



□ 79013  
Lake-town Guard  
Garde de Lacville  
Guarda de Ciudad del Lago



□ 30215  
Legolas Greenleaf™



□ 79014  
Radagast™



□ 79014  
Necromancer of  
Dol Guldur  
Nécromancien de  
Dol Guldur  
Nigromante de Dol  
Guldur



□ 79012  
Mirkwood™ Elf  
Elfe de Mirkwood™  
Elfo de Mirkwood™



□ 79012  
Warg



# WIN!

Go to [LEGO.com/productfeedback](http://LEGO.com/productfeedback) to fill out a survey for a chance to win a cool LEGO® Product.

No purchase necessary.  
Open to all residents where not prohibited.



## LEGO.com/productfeedback

### GEWINNE!

Nimm an der Umfrage auf [LEGO.com/productfeedback](http://LEGO.com/productfeedback) teil und hab die Chance ein cooles LEGO® Produkt zu gewinnen!

Die Teilnahme am Gewinnspiel führt zu keinerlei Kaufverpflichtungen. Teilnahme in allen nicht ausgeschlossenen Ländern möglich.

### WIN!

Ga naar [LEGO.com/productfeedback](http://LEGO.com/productfeedback), vul een enquêteformulier in en maak kans op een cool LEGO® product.

Geen aankoopverplichting. Iedereen mag deelnemen, uitgezonderd ingezetenden van landen waar een enquêteverbod geldt.

### GAGNE!

Visite [LEGO.com/productfeedback](http://LEGO.com/productfeedback) pour répondre à un questionnaire et avoir une chance de gagner un produit LEGO® très cool!

Aucune obligation d'achat.  
Ouvert à tous les résidents des pays autorisés.

### 当てよう!

[LEGO.com/productfeedback](http://LEGO.com/productfeedback) にアクセスして、アンケートにご記入ください。当選者にはレゴ®製品を差し上げます。

お買い上げの必要はありません。禁止されていない限り、すべての皆様にご利用いただけます。



[LEGO.com](http://LEGO.com)

6073506

LEGO, the LEGO logo and the Minifigure are trademarks of the/sont des marques de commerce de/son marcas registradas de LEGO Group.  
©2013 The LEGO Group.

THE HOBBIT: THE DESOLATION OF SMAUG: © WBEI™ Middle-earth Ent. Lic. to New Line.  
LE HOBBIT: LA DÉSOLATION DE SMAUG: © WBEI™ Middle-earth Ent. Lic. à New Line.  
EL HOBBIT: LA DESOLACIÓN DE SMAUG: © WBEI™ Middle-earth Ent.; uso autorizado a New Line.  
(s13)