

**LEGO**



8639



**WARNING:** CHOKING HAZARD.  
Toy contains small parts and a small ball.  
Not for children under 3 years.



1

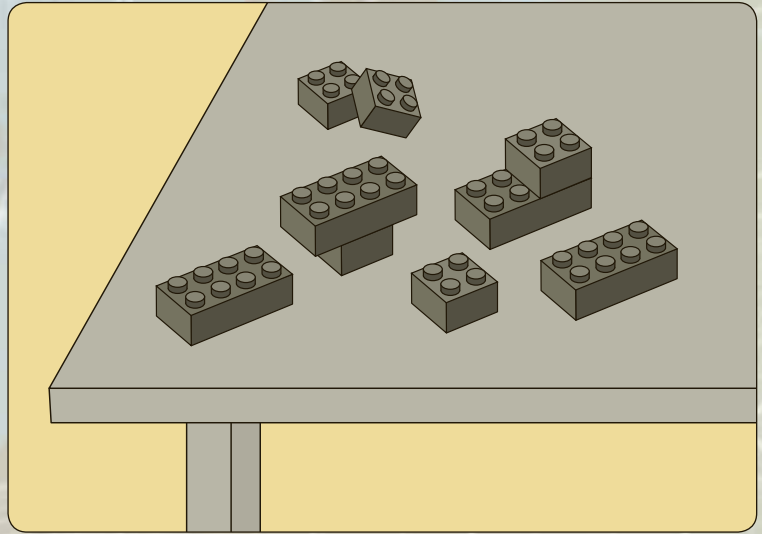
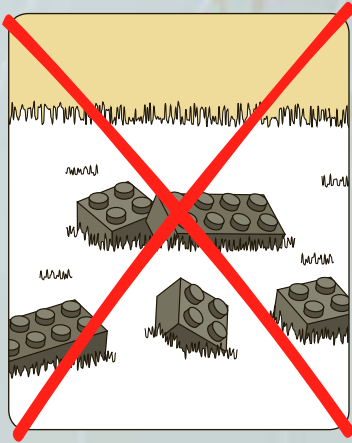

2



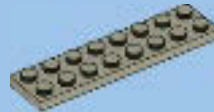
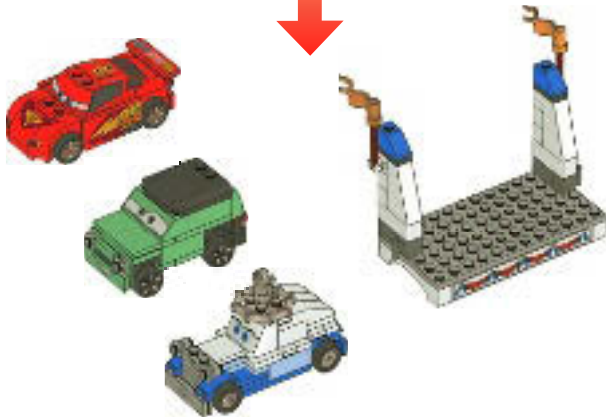

1x

1



2x

2



 **AVERTISSEMENT** : RISQUE D'ÉTOUFFEMENT.  
Le jouet contient des petites pièces ainsi qu'une petite boule.  
Il ne convient pas aux enfants de moins de 3 ans.

 **ADVERTENCIA**: PELIGRO DE ASFIXIA.  
Juguete que contiene partes pequeñas y una pelota pequeña.  
No recomendado para niños menores de 3 años.





3



4

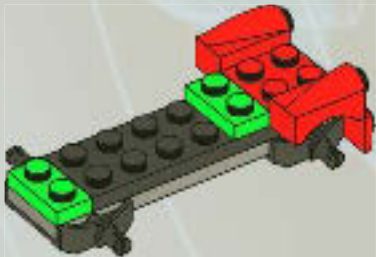

5

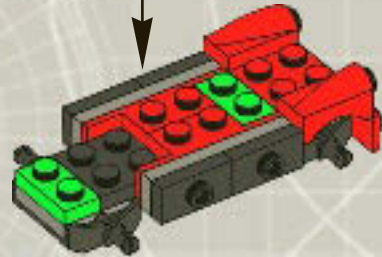
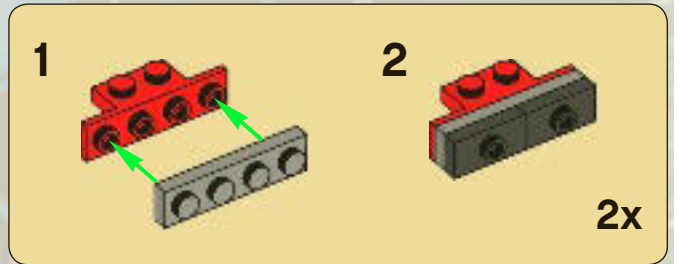



6



7



8

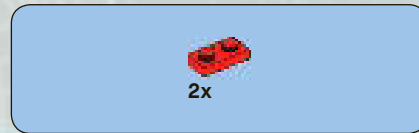

9

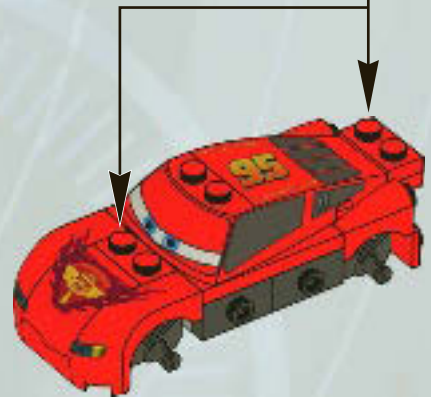



2x

# 10



4x



4x



1:1

# 12



1x

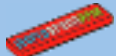

1x

# 11

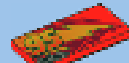

1x

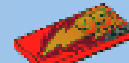

1x

# 13





1x

1



1x

2



1x

3



1x

4







1x

5



1x



1x



1x

6



1x



1x

7

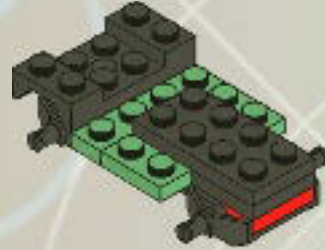

1x



1x

8







9



10

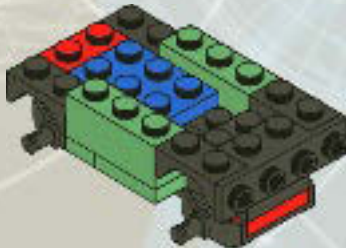

11

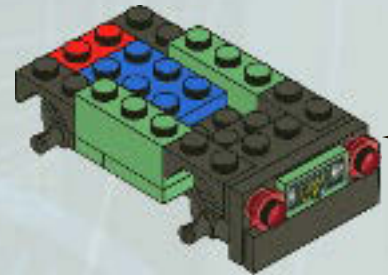



# 12

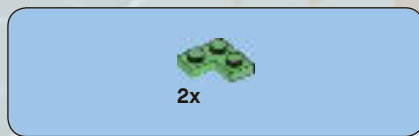
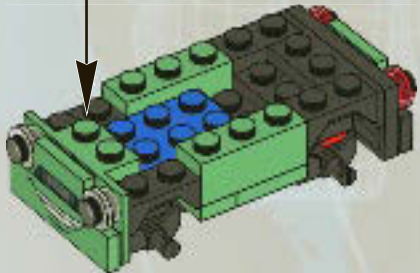
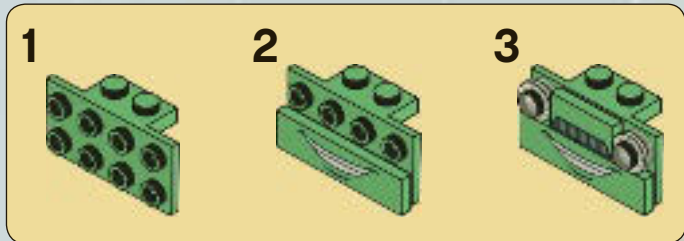

# 13

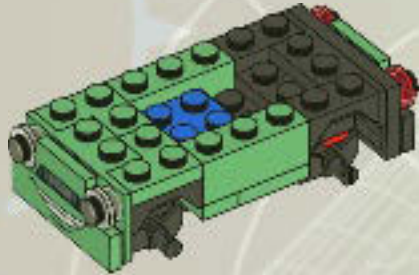

# 14

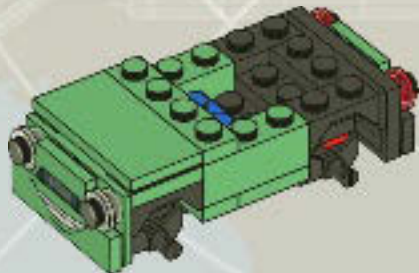



1x

# 15

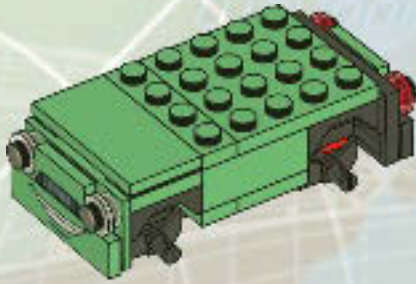

1x



1x

# 16

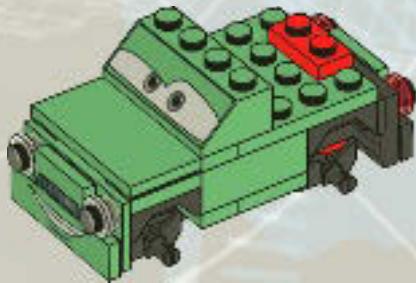

2x



2x

# 17



2x

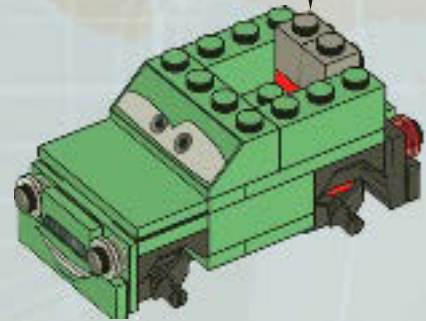



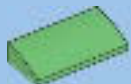

1x

# 18

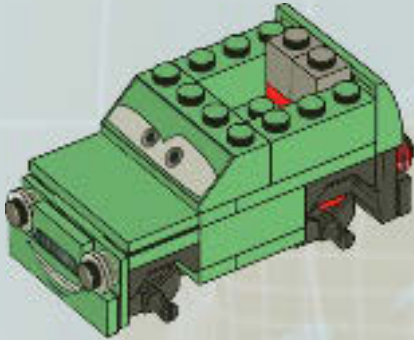
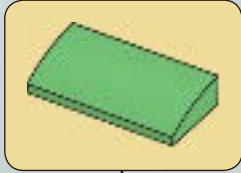

1x



4x



4x



1:1

# 19

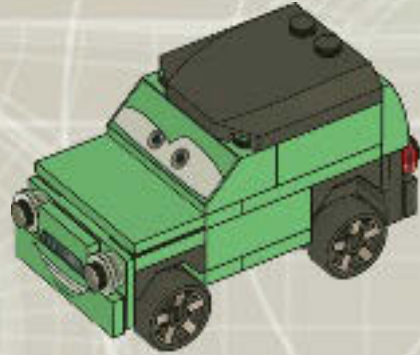



1



2



3

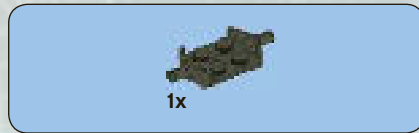
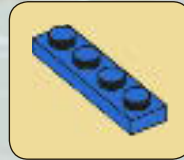

4

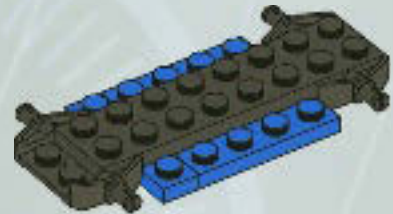



1x

5

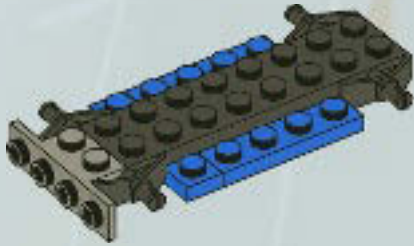

2x



2x

7

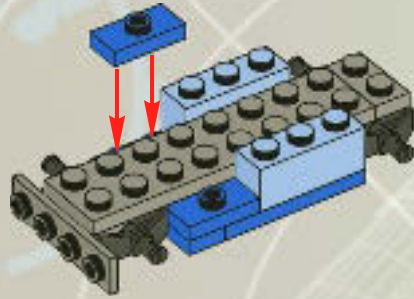

1x



1x

6

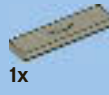
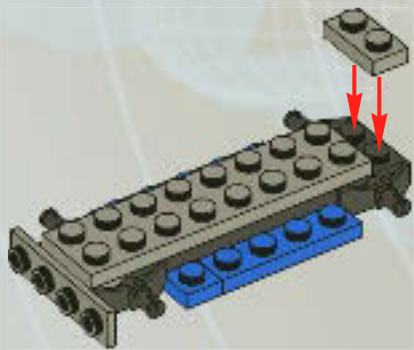

1x



2x

8

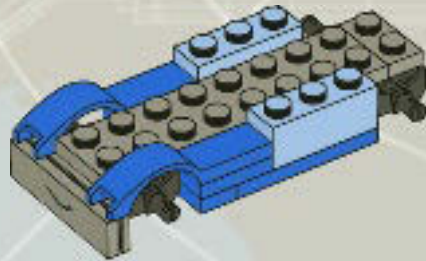





9

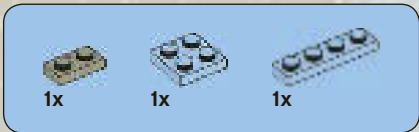
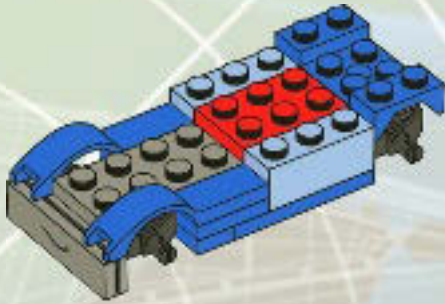

10

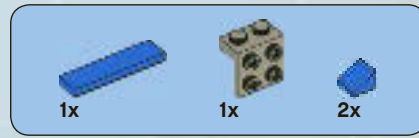
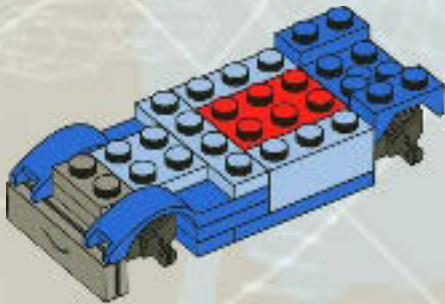

11

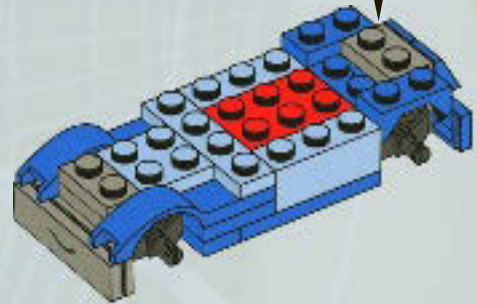
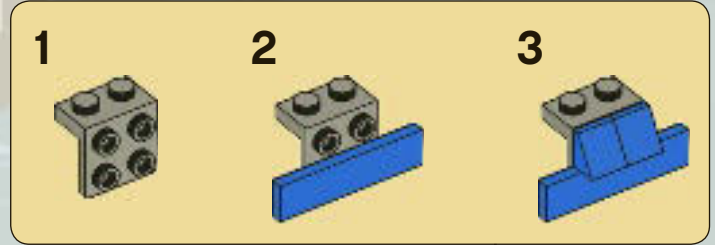

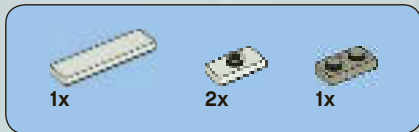

# 12

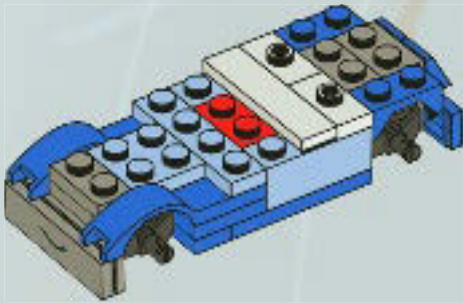

# 13

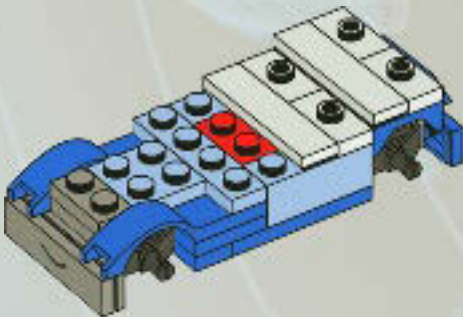

# 14

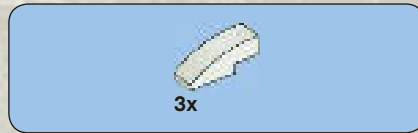
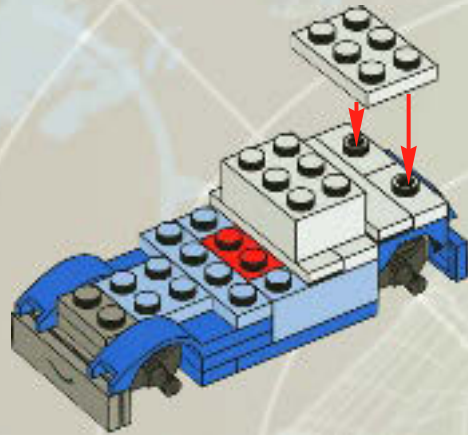

# 15

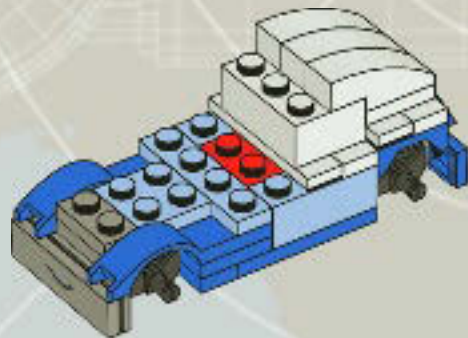

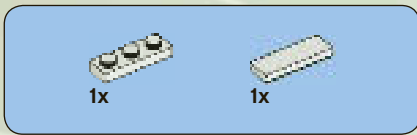

# 16

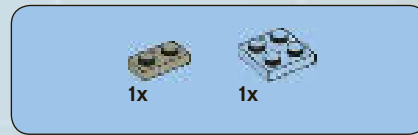
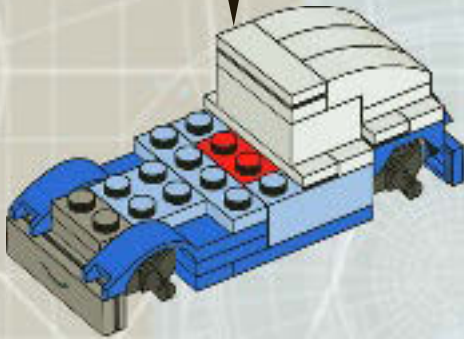
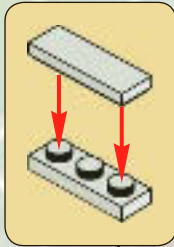

# 17

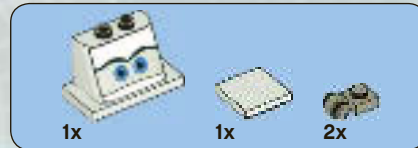
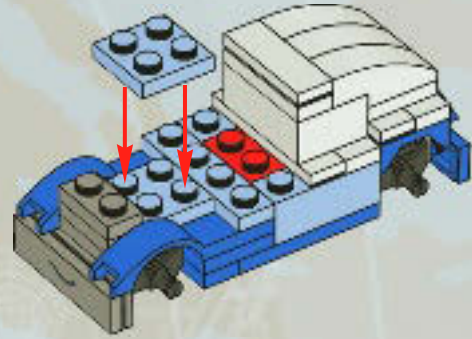

# 18

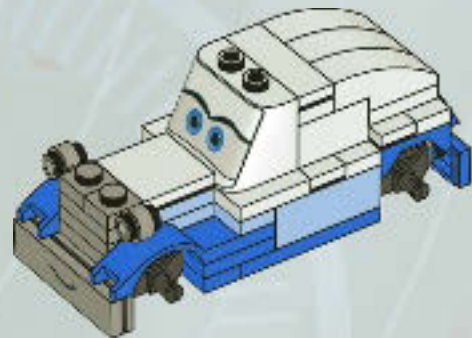





19

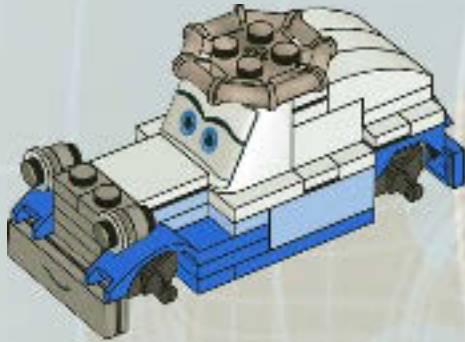

20

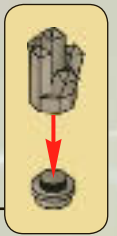
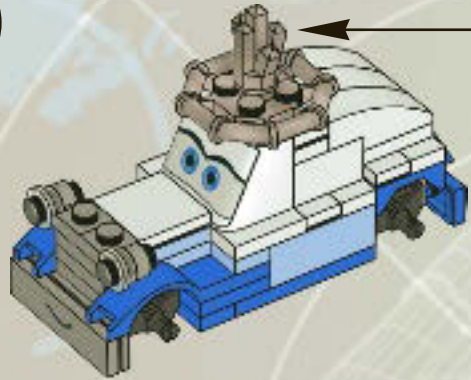

21

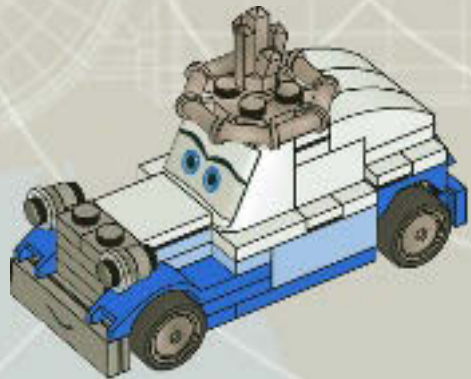

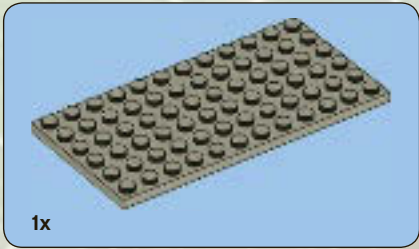

1

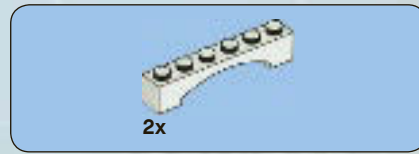
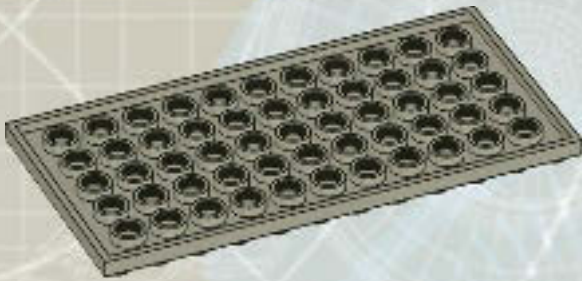

2

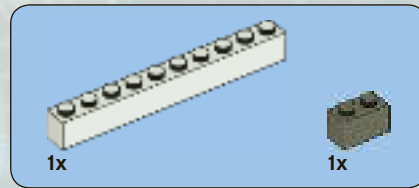
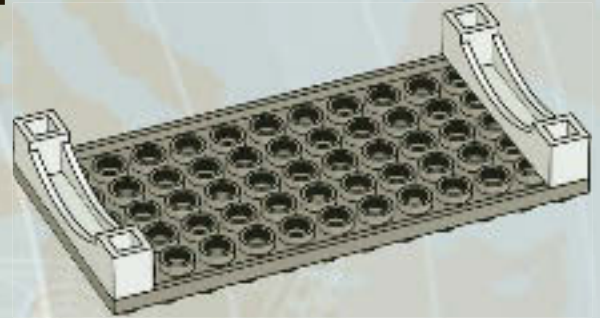

3

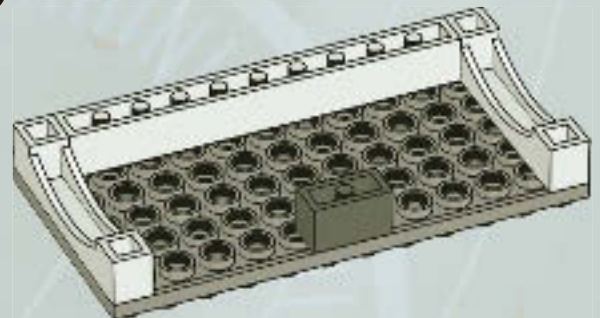



2x



2x

4

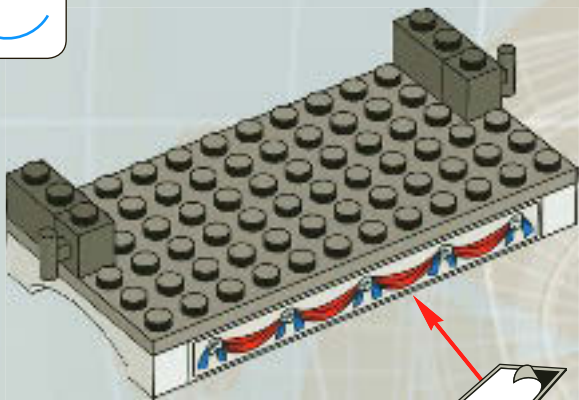

2x

5

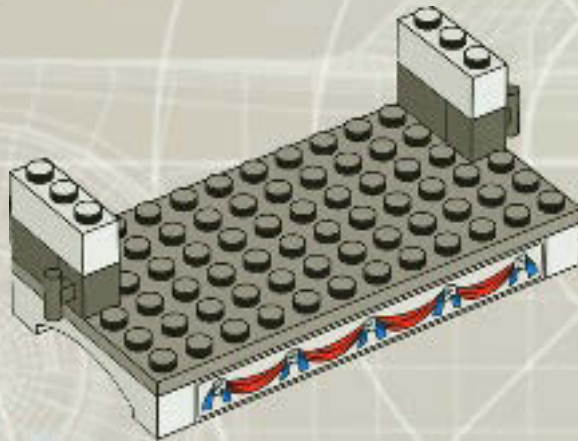



4x



2x

6

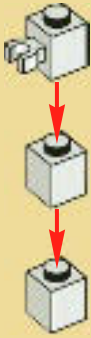

2x

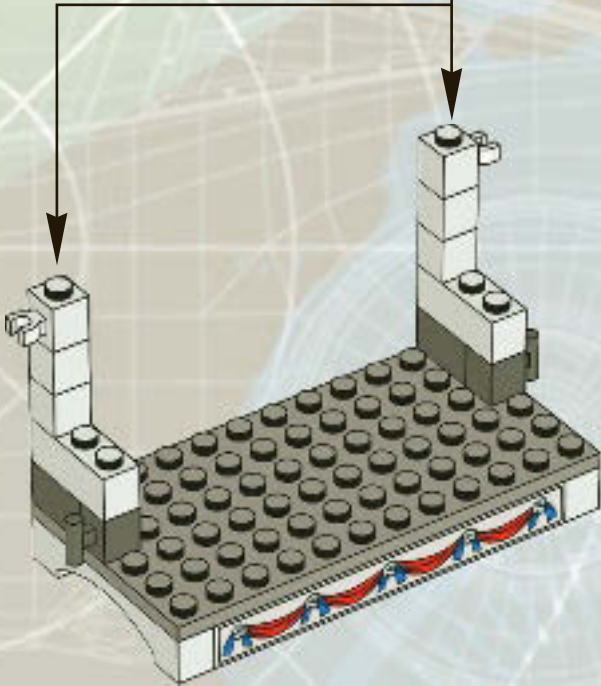

2x

7

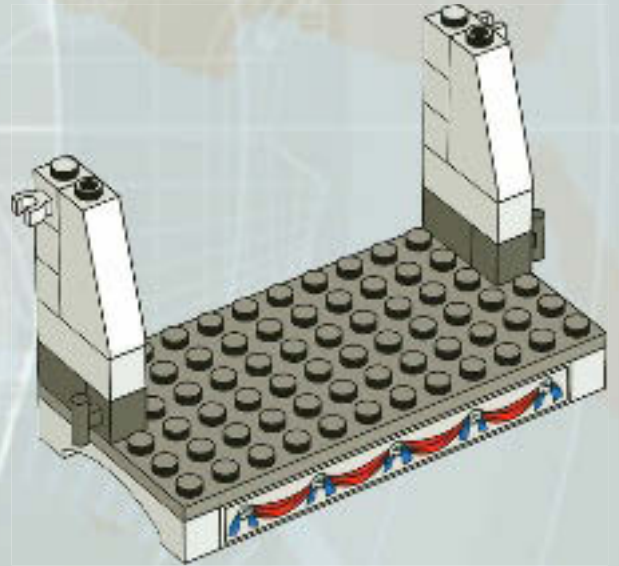





2x



2x

8

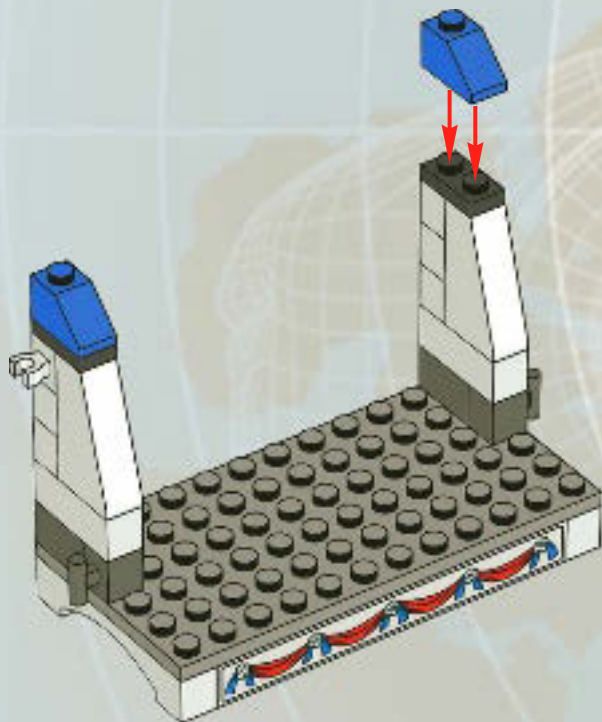

2x



2x

9



2x

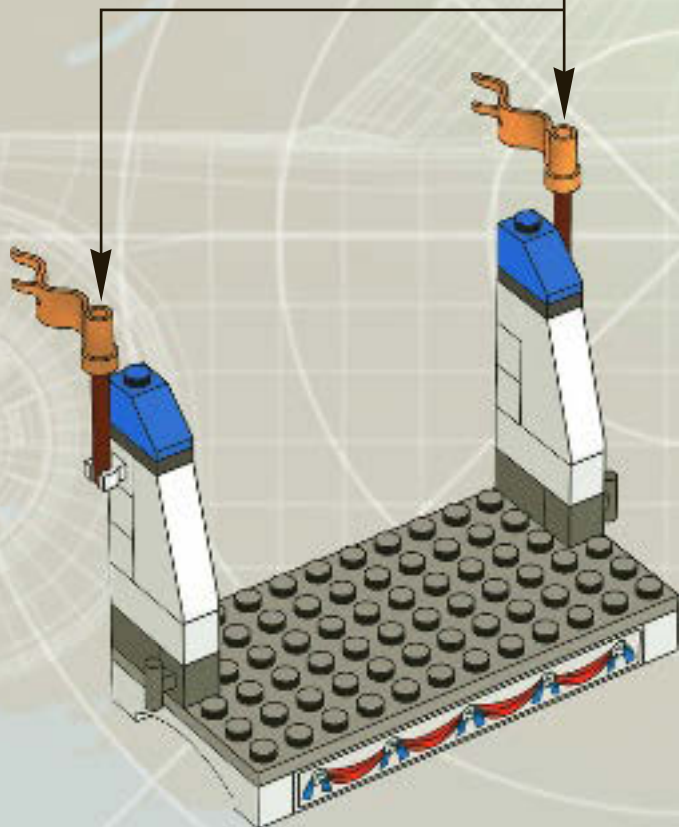

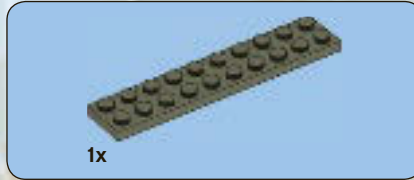

1



2

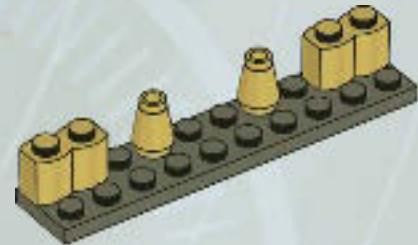



3

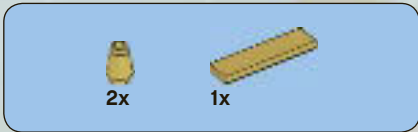
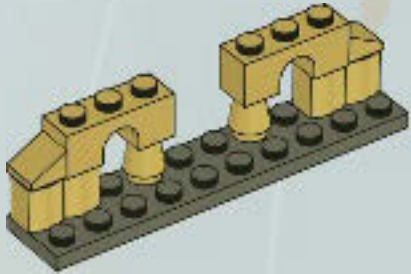

4

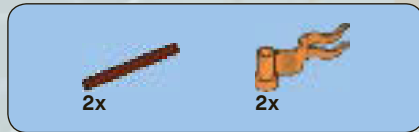
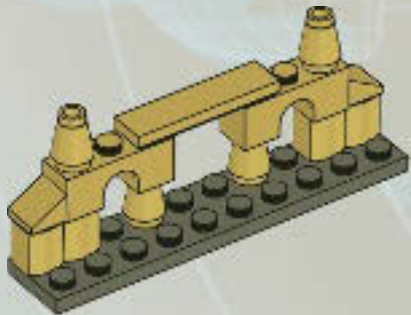

5

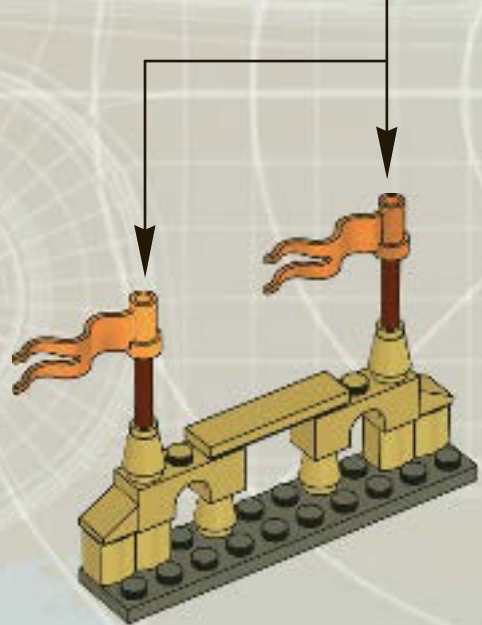



1

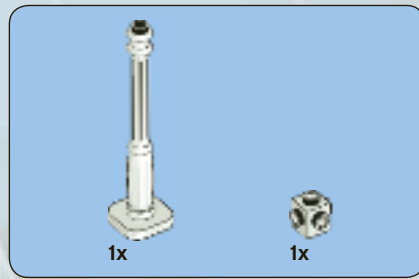

2







3

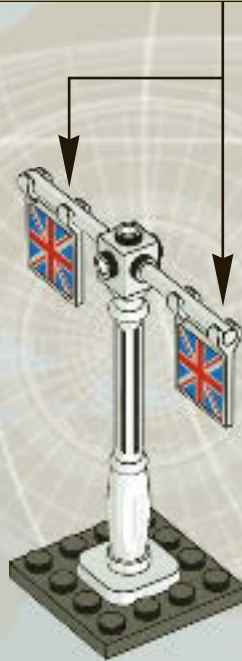
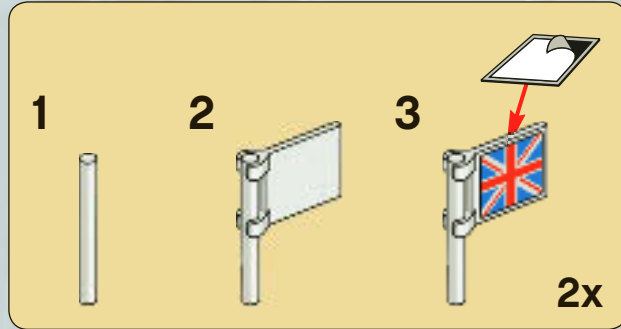



1x



1x

4

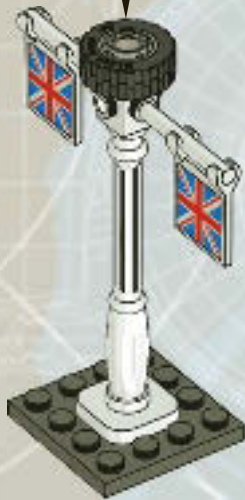
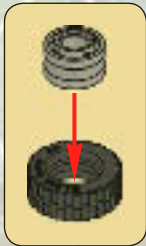

2x



2x

5

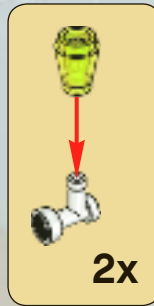

2x



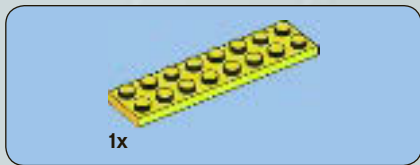

**1**

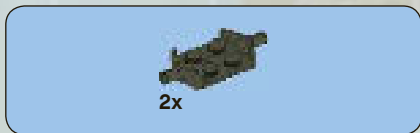
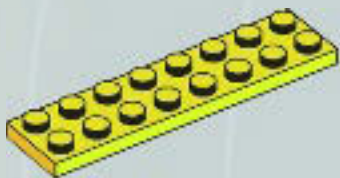

**2**

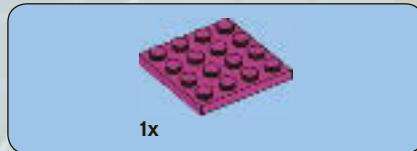

**3**

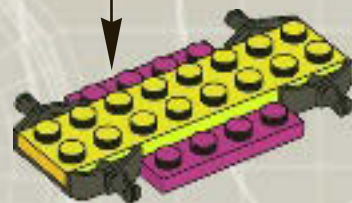



2x

4



1x



2x

5



1x



1x

6

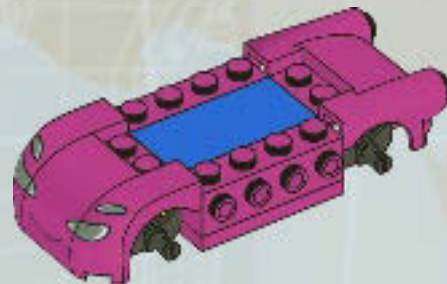



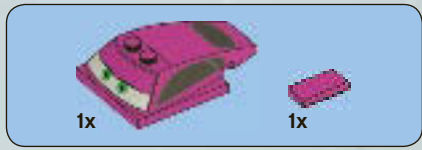

7

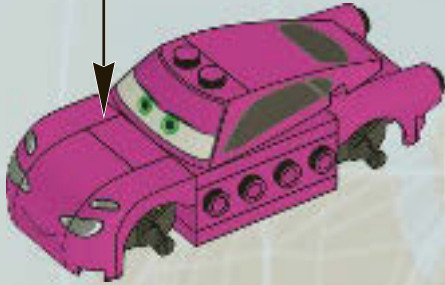

8

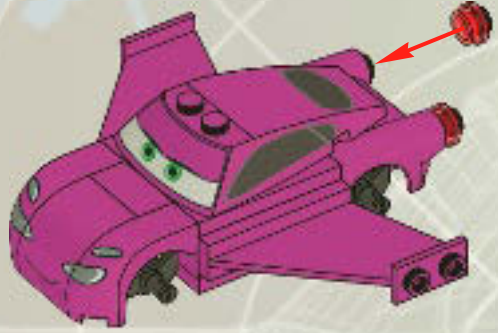

9

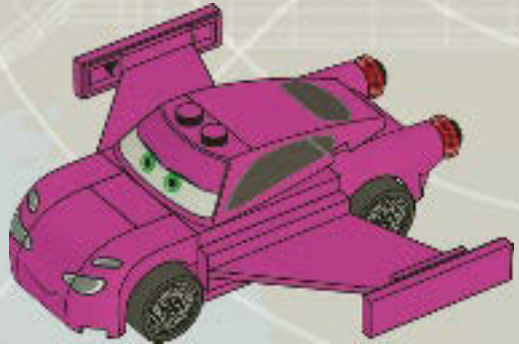



1x

1



2x

2



1x

3





4

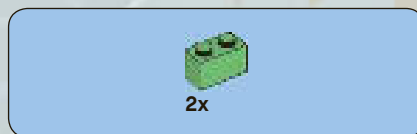
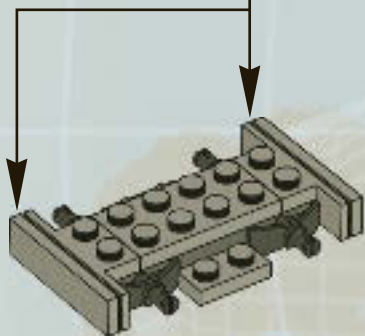
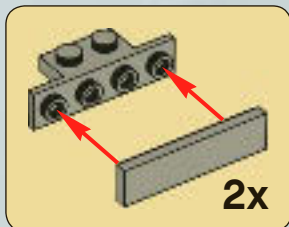

5

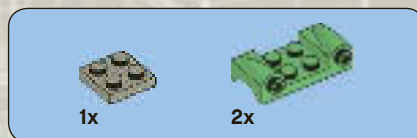
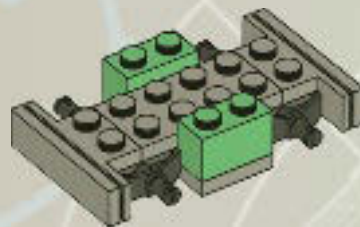

6

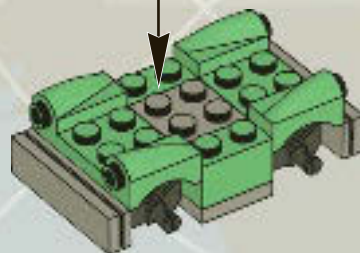



2x



1x

7

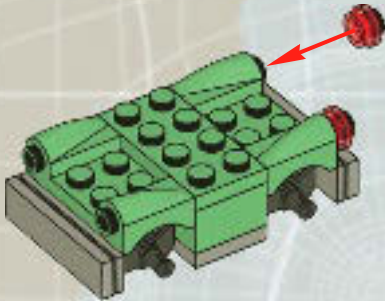

2x



1x

8

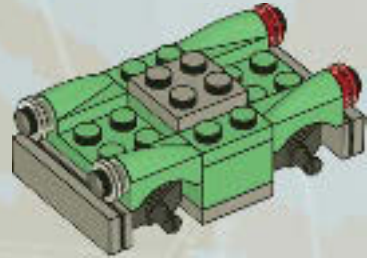

1x



2x

9

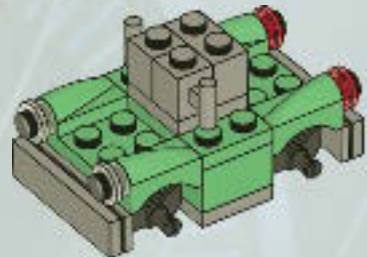





1x

# 10

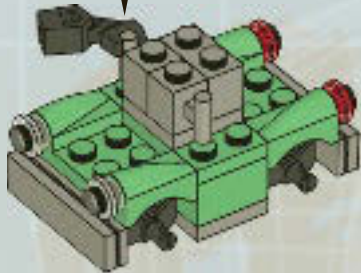

2x



1x



1x

# 11

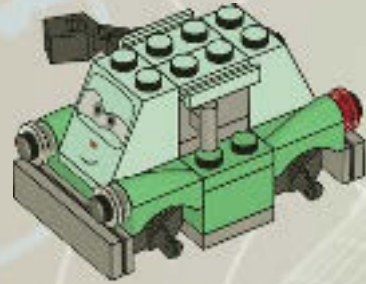

1x

# 12

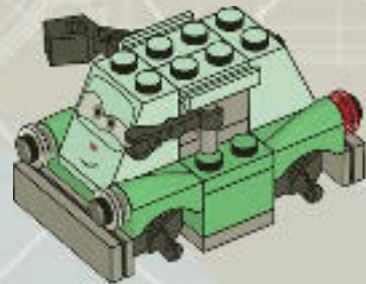



1x

# 13

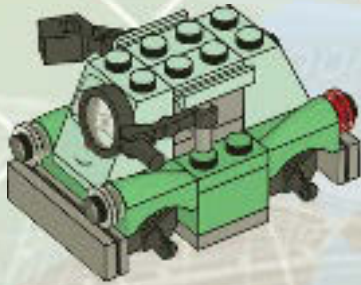

2x

# 14

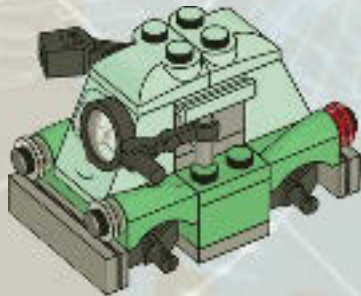

4x



4x



1:1

# 15

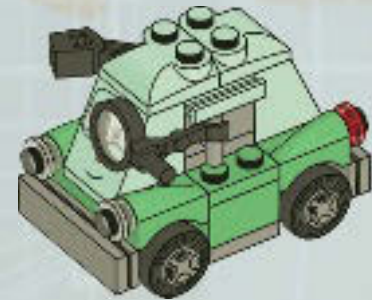

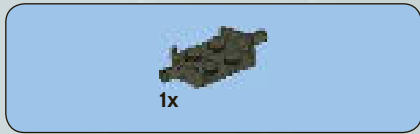

1

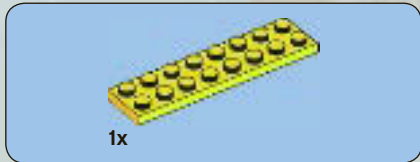

2

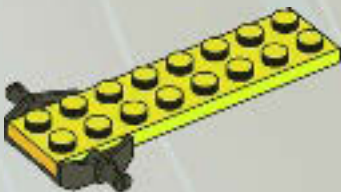

3

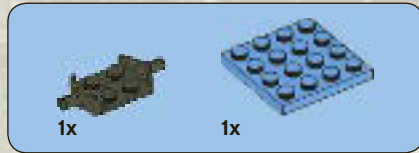
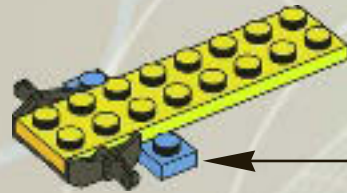
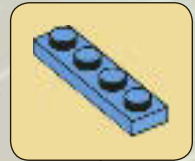

4

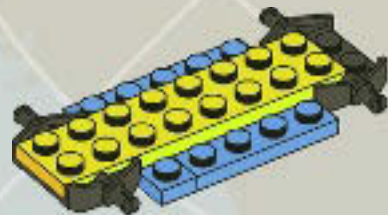



2x

5



1x



1x

6

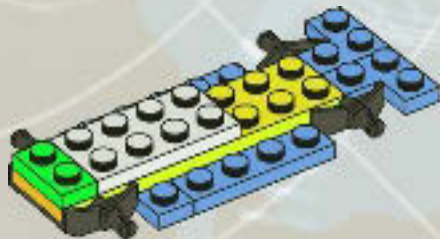

1x



2x

7

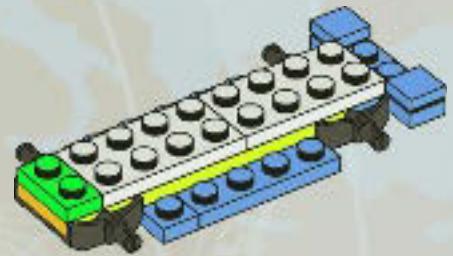

2x

8

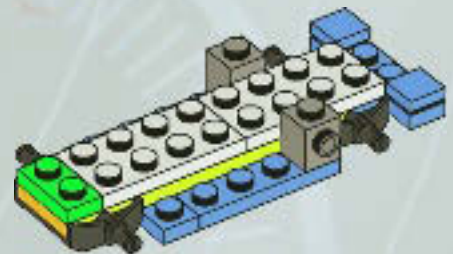





2x

# 9

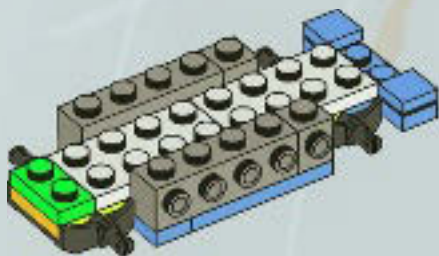

1x



1x



1x

# 10

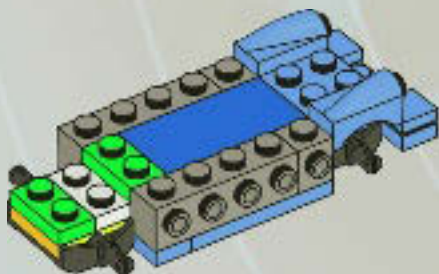

2x

# 11

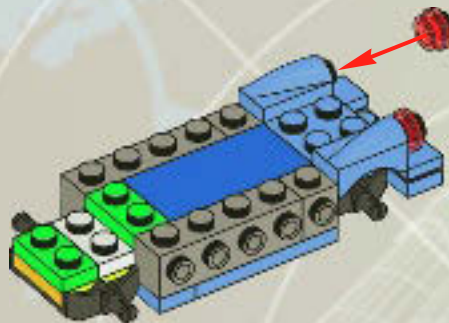

2x

# 12

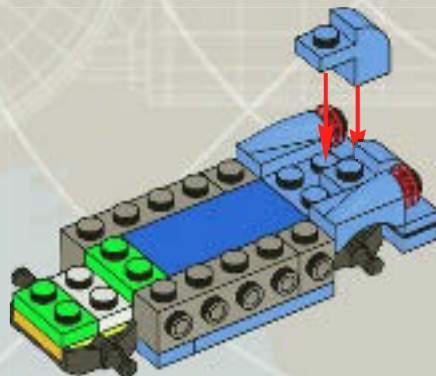



2x

# 13

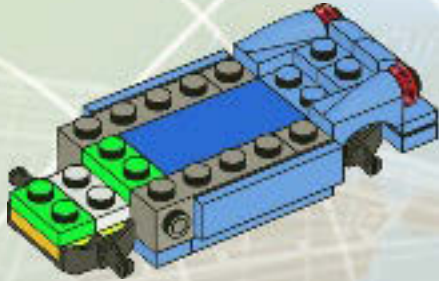

2x

# 14

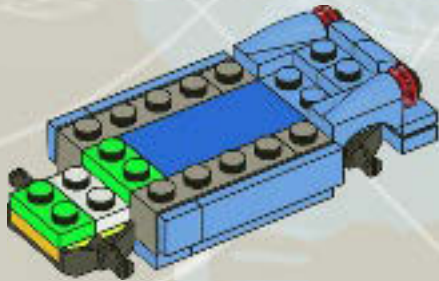

1x

# 15

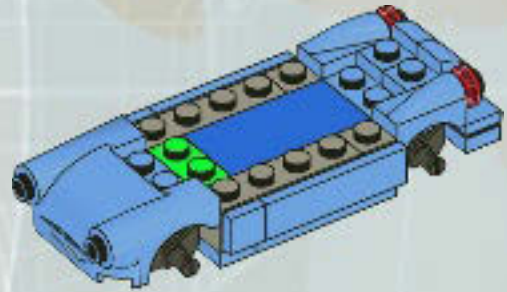

2x



2x

# 16

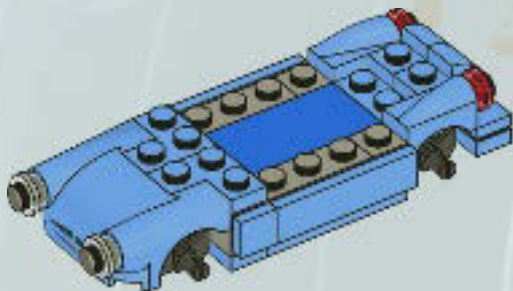

1x



# 17

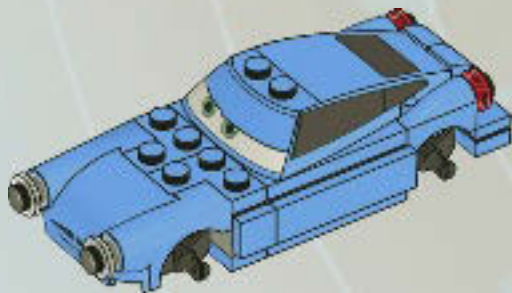

4x



4x



1:1

# 18

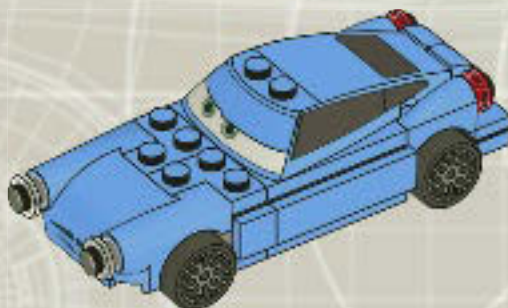

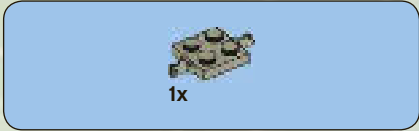

**1**

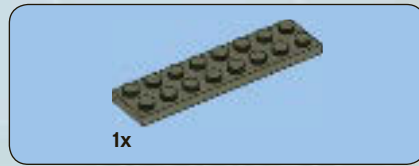

**2**

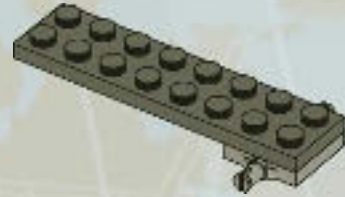

**3**

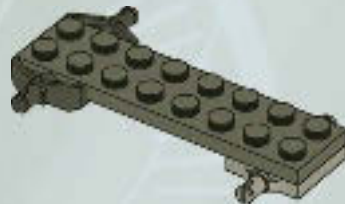





1x

4

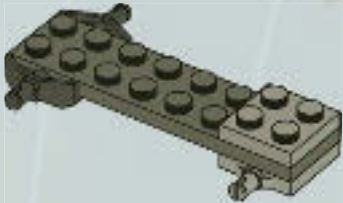

1x

5

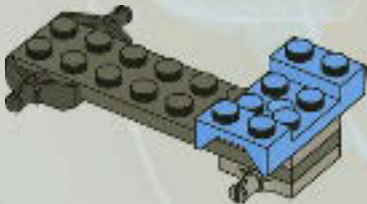

1x



1x



1x



1x

6

1

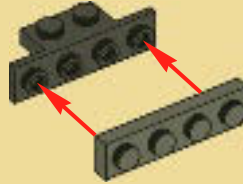

2

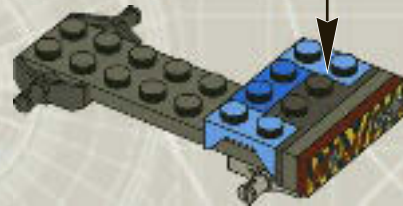
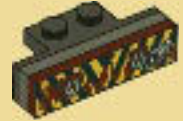

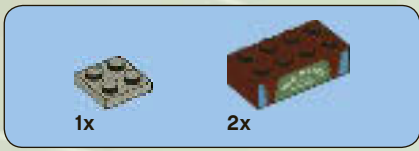

7



8

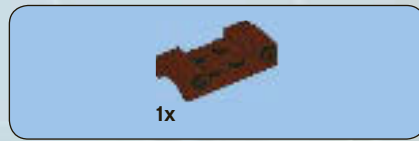

9



10

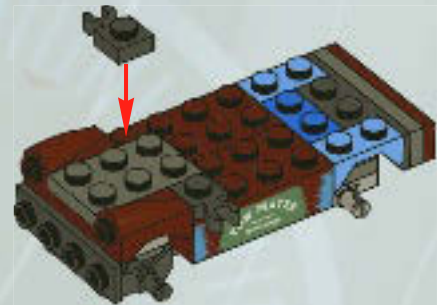



1x



1x



1x

# 11



1x



1x

# 12



1x



2x

# 13

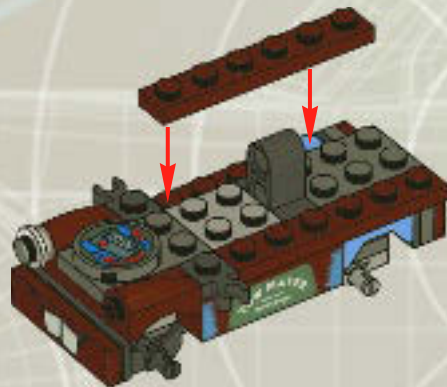



2x

# 14

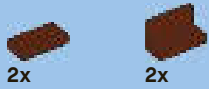
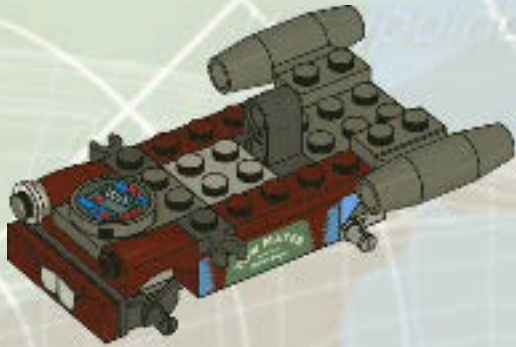

2x

2x

# 15

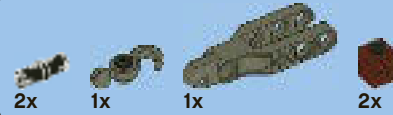
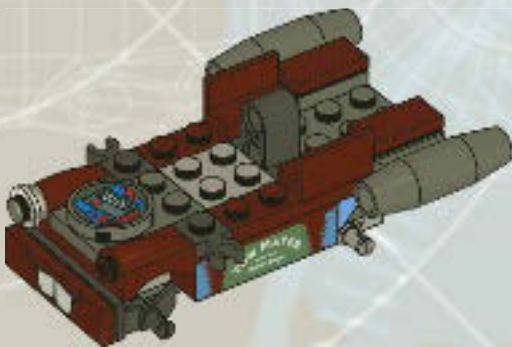

2x

1x

1x

2x

# 16

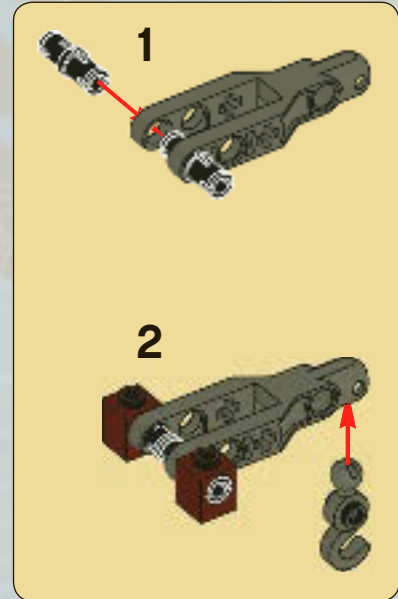

1

2

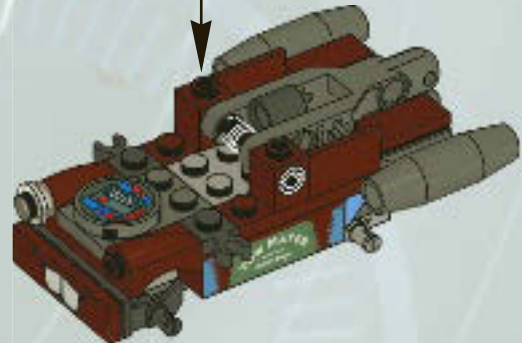





1x



1x

# 17

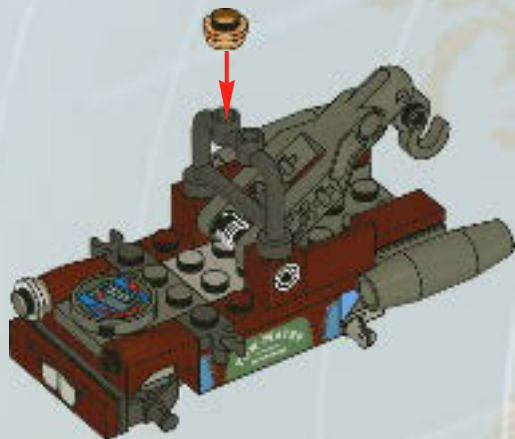

2x

# 18

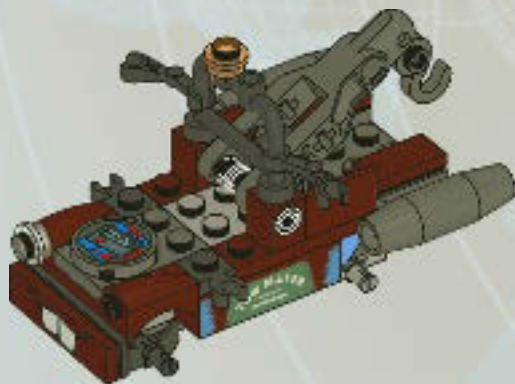

2x

# 19

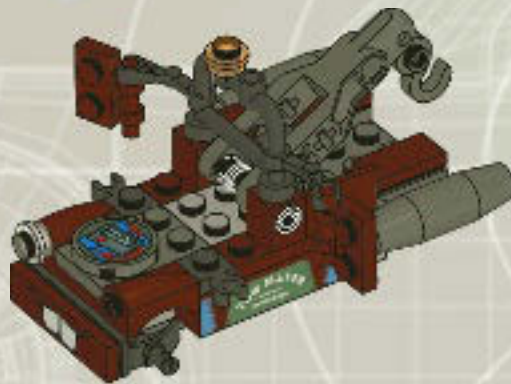



1x

# 20



1x

# 21



2x



2x

# 22

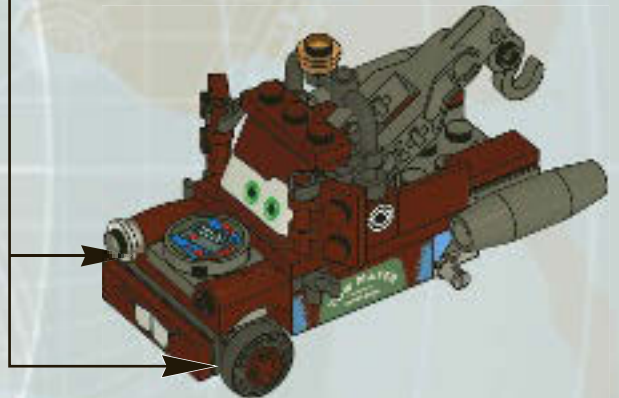
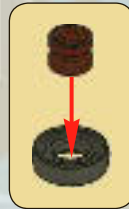



2x



2x

# 23

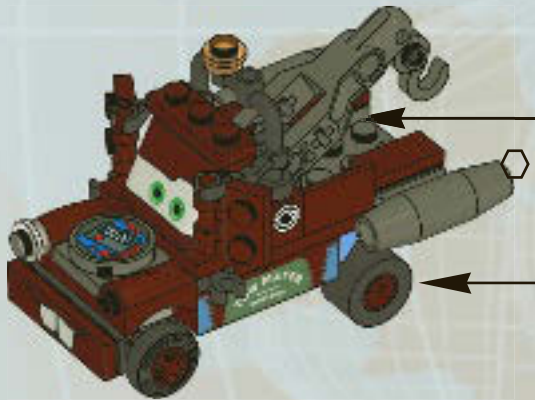
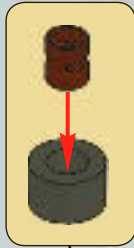

2x

# 24



2x

