



# NINJAGO

Masters of Spinjitzu



9456



VS





1

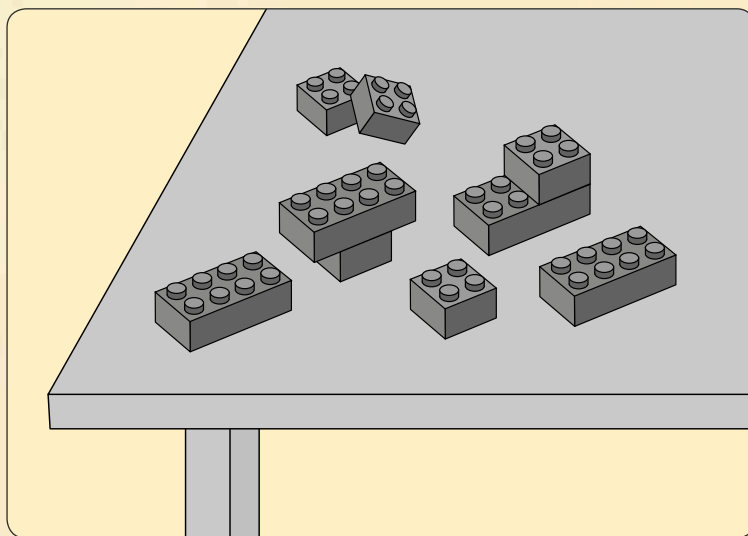
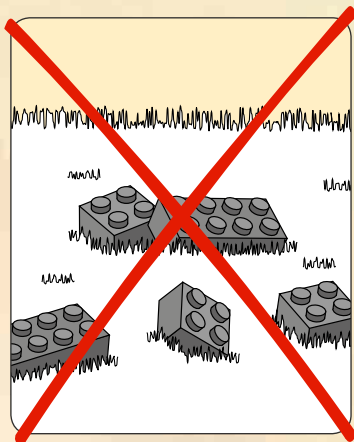

2



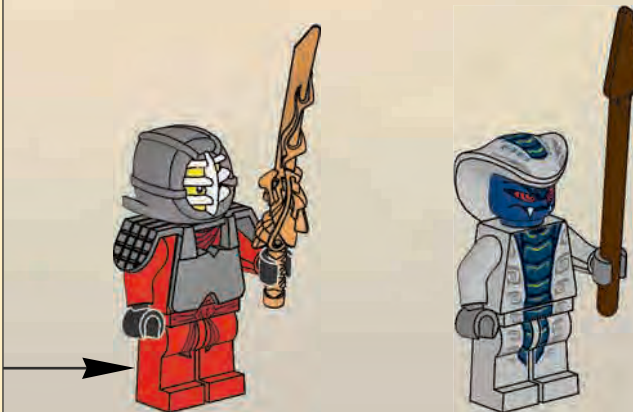
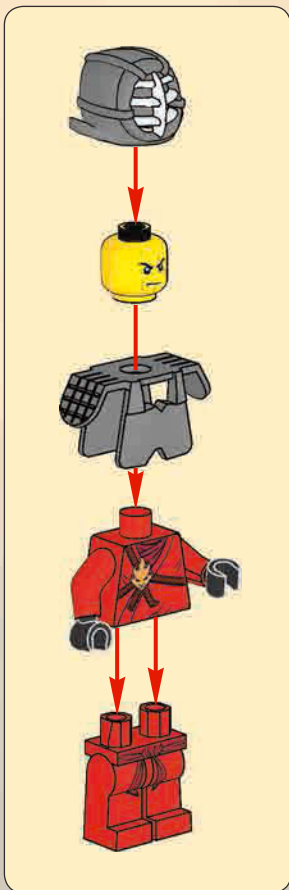
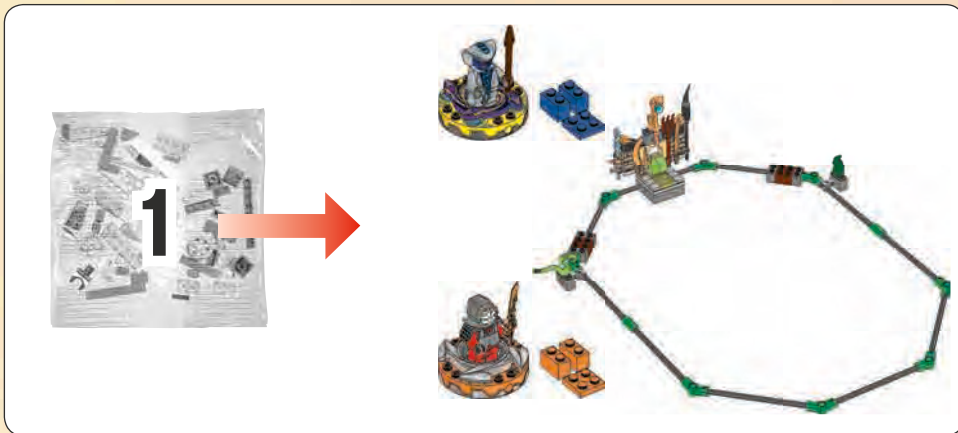



1



2



3

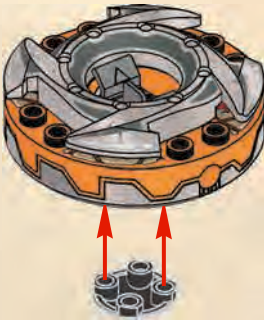

4

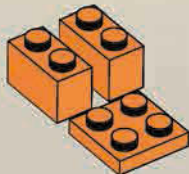

4

1



2



3



4

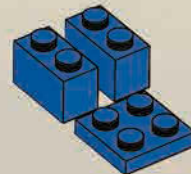

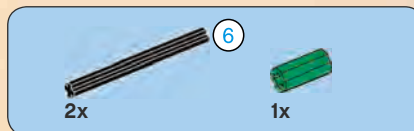
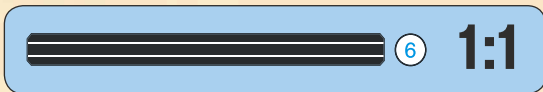
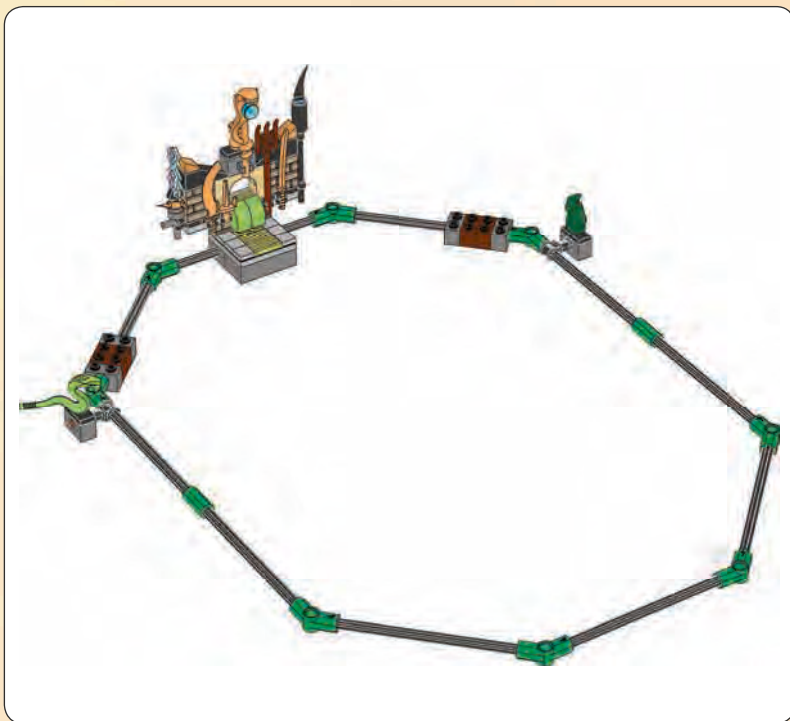

1

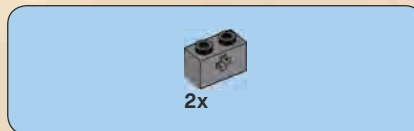
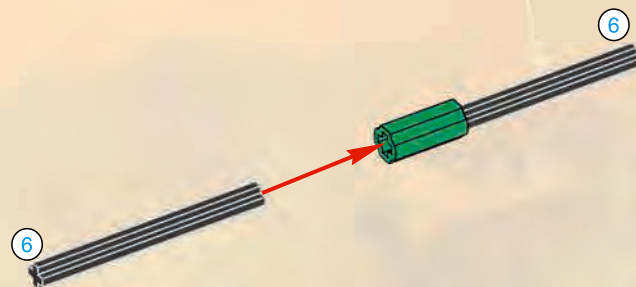

2

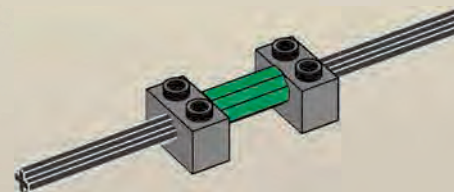

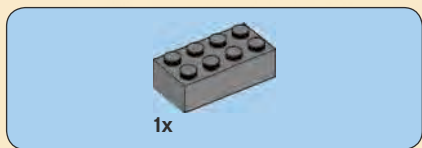

3

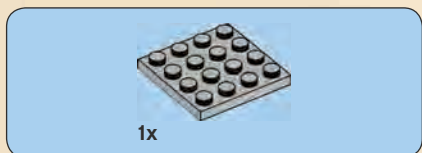
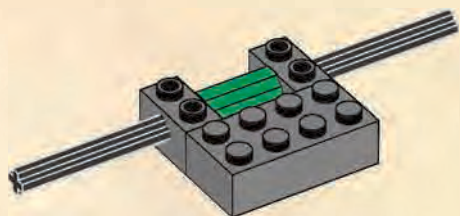

4

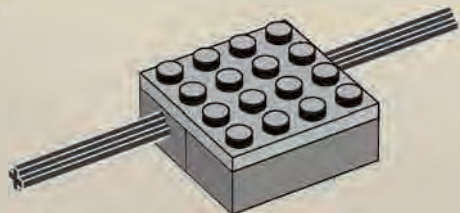

6



5

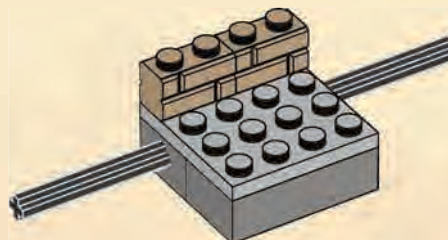

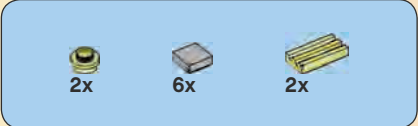

6

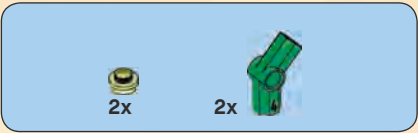
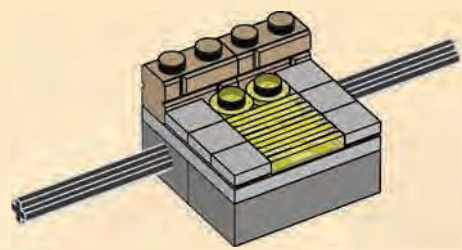

7

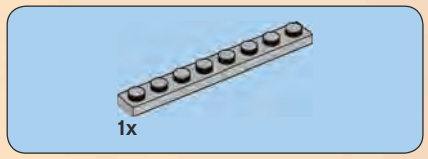
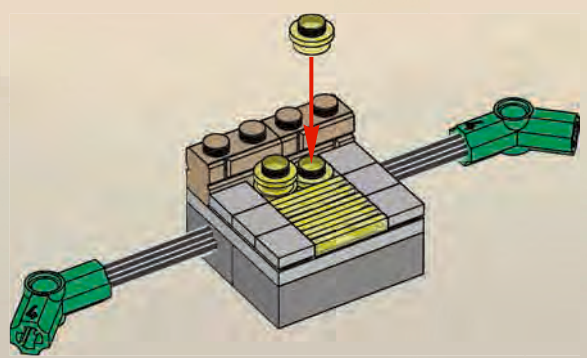

8

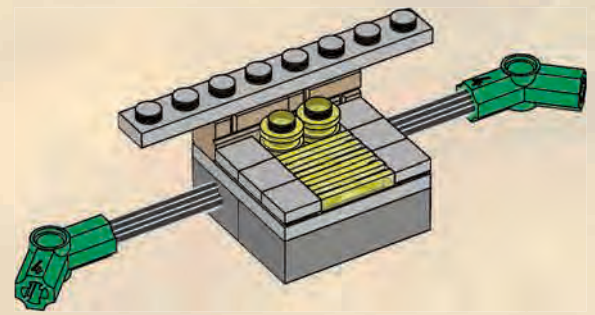



2x

# 9

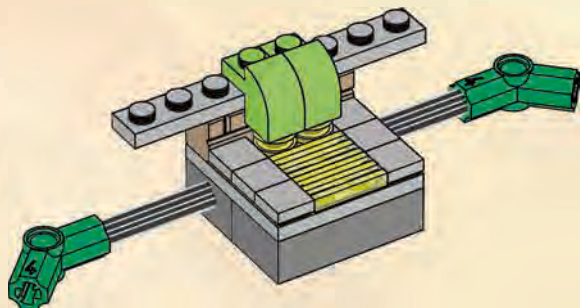

1x



6x

# 10

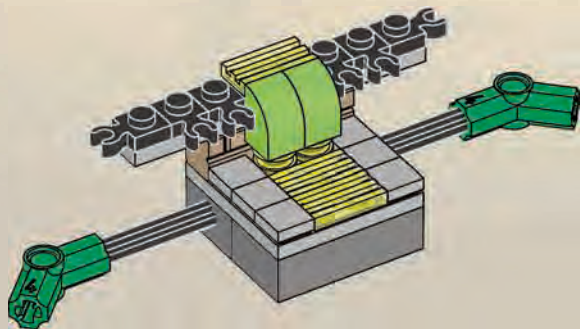

8

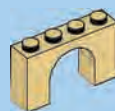

1x

# 11

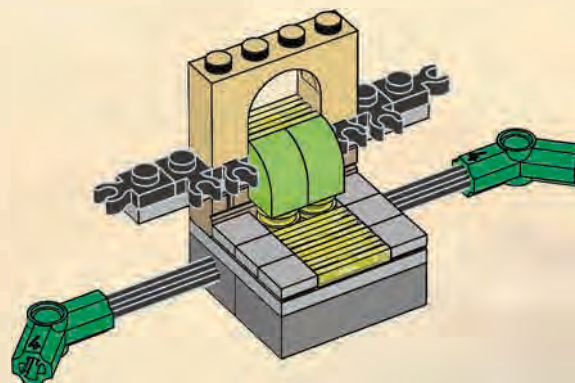





4x

# 12

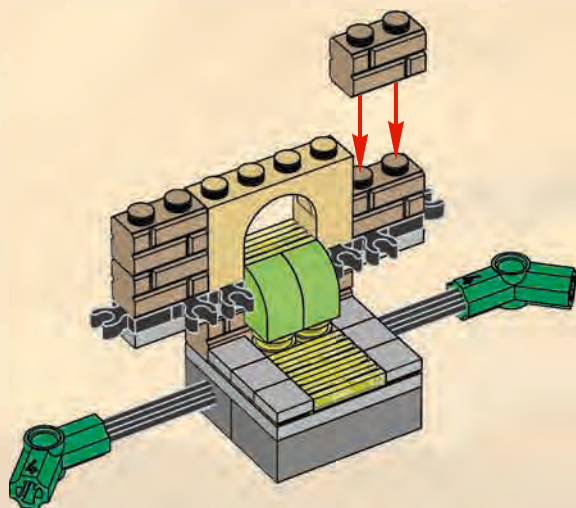

2x



1x

# 13

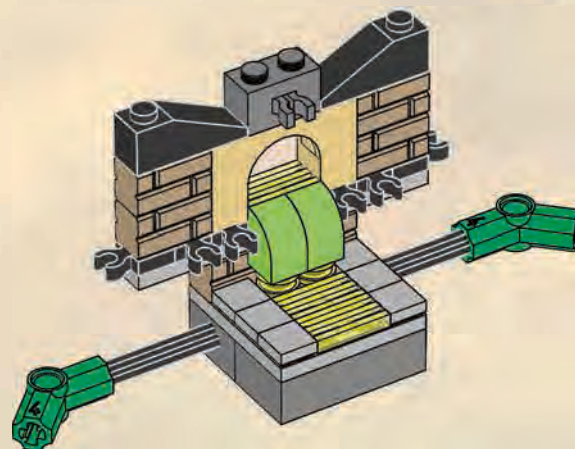

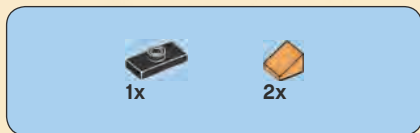

# 14

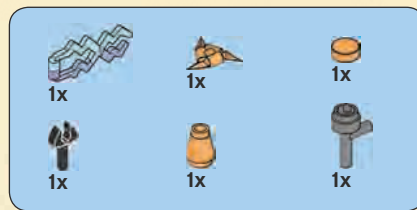
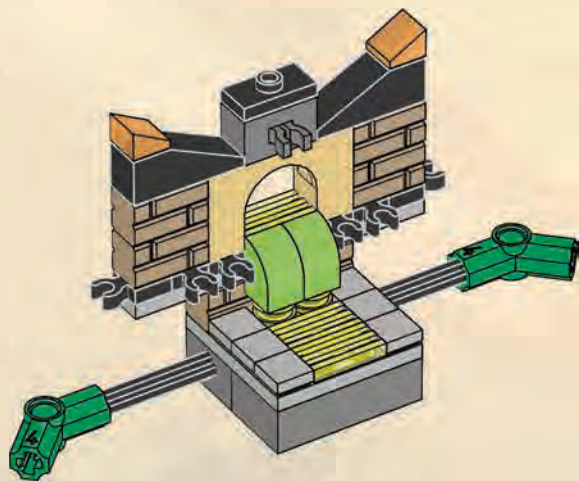

# 15

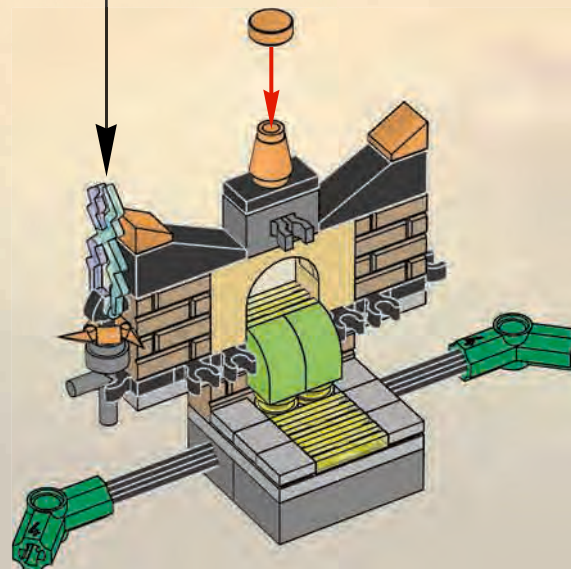
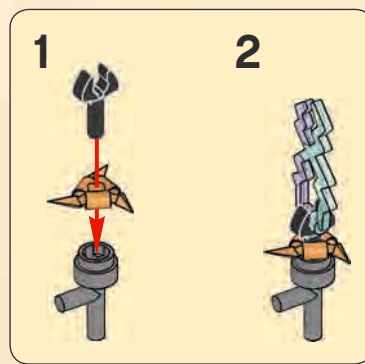

10



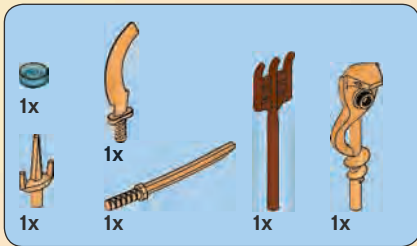

16

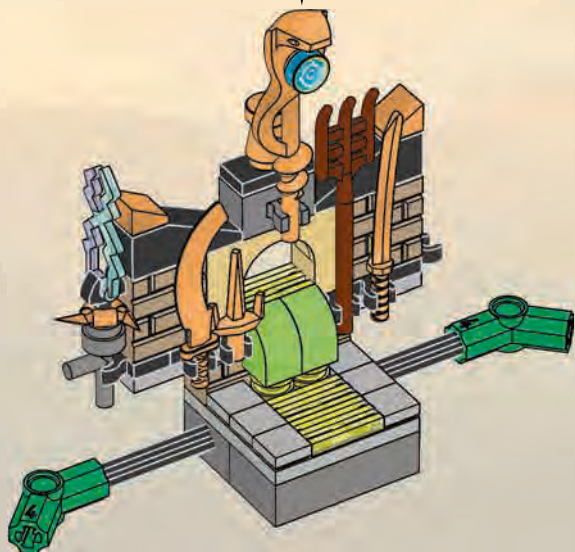
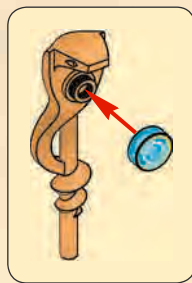

17

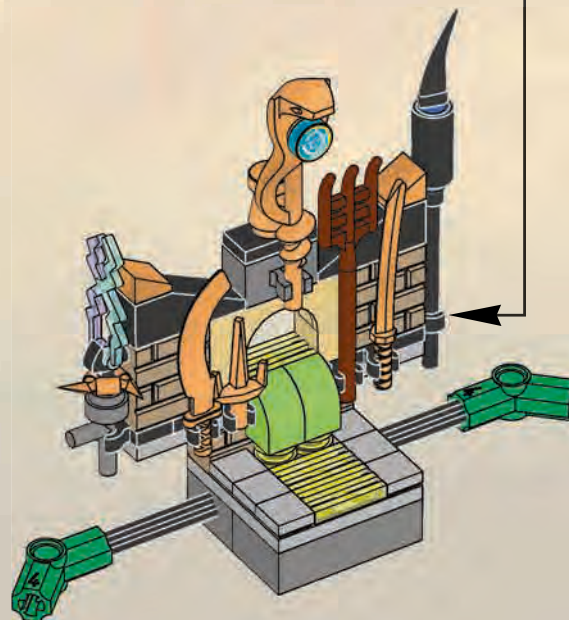
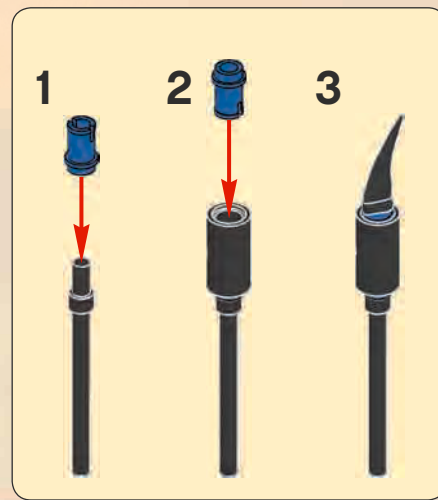

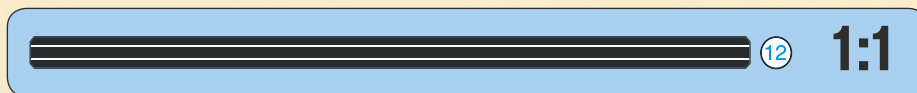
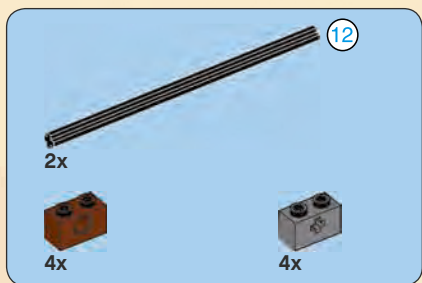

# 18

## 1



## 2

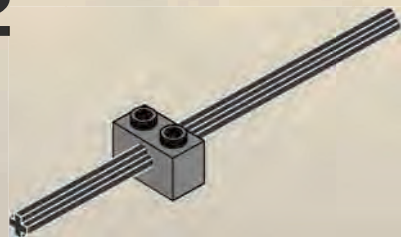

## 3

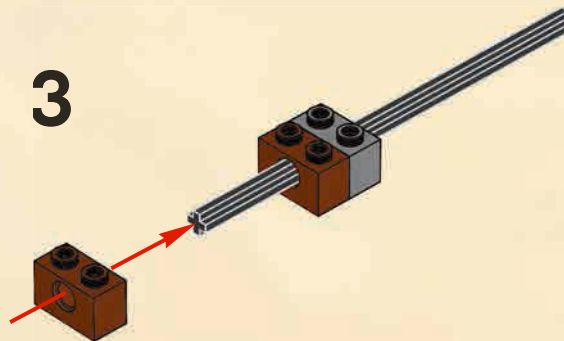

## 4

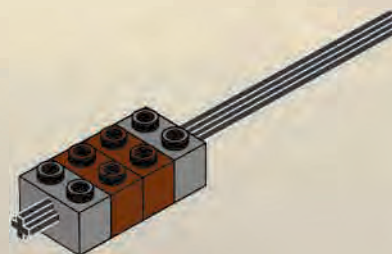

# 2x

12



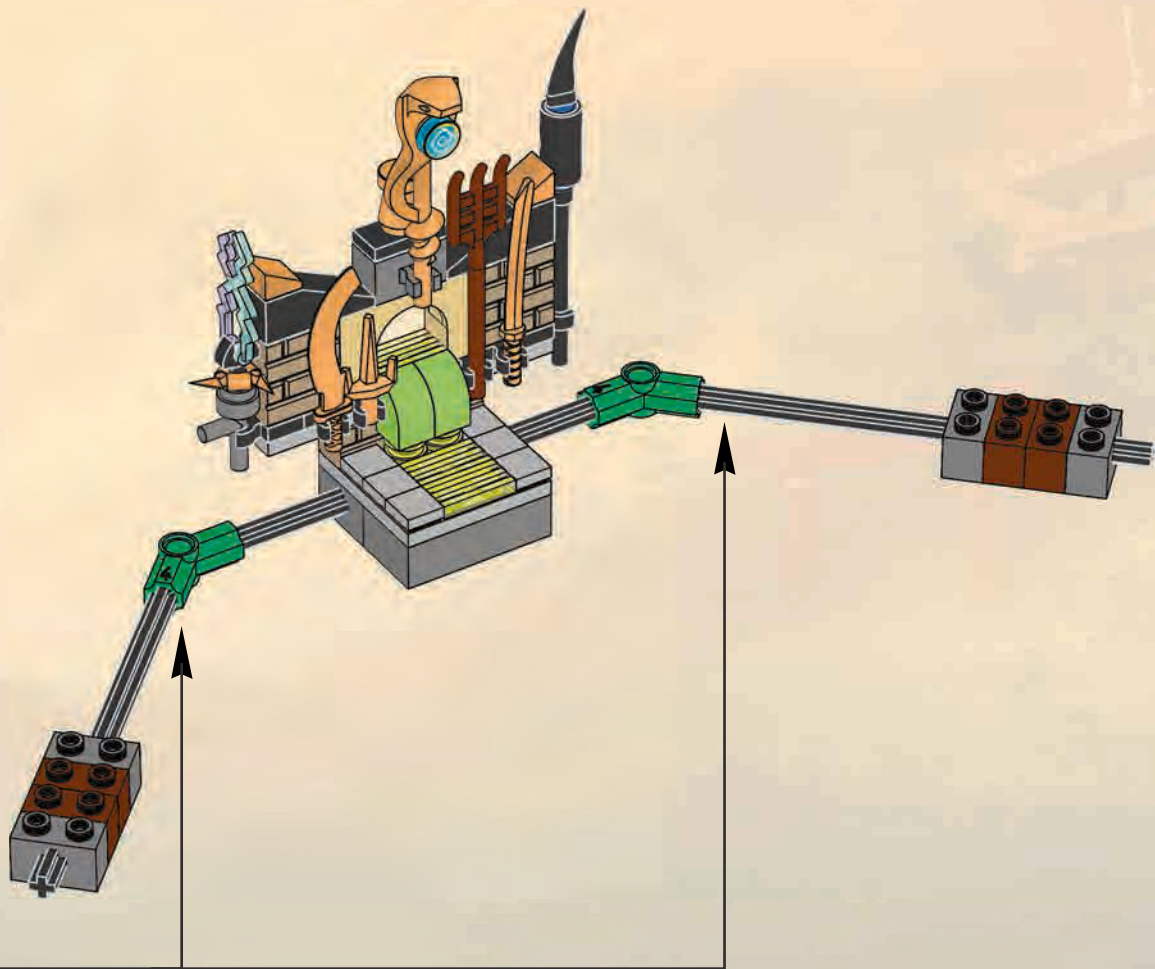

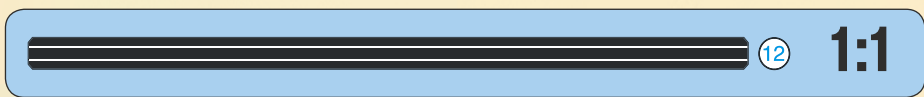
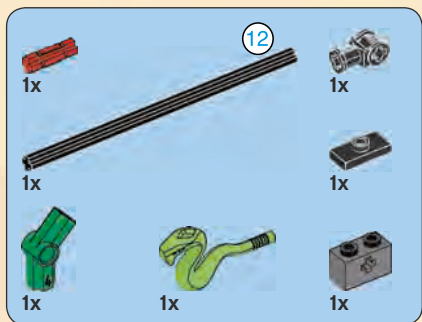

19

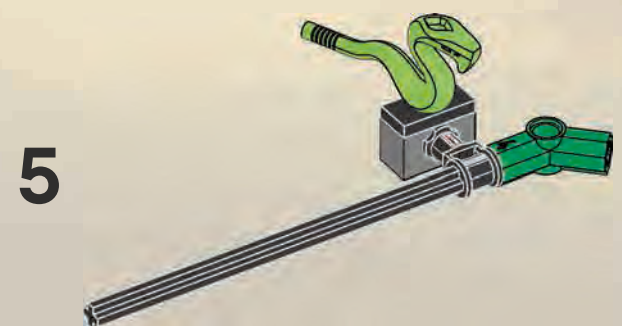
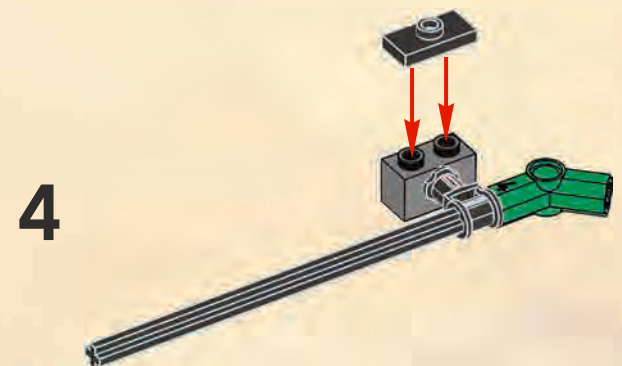

14



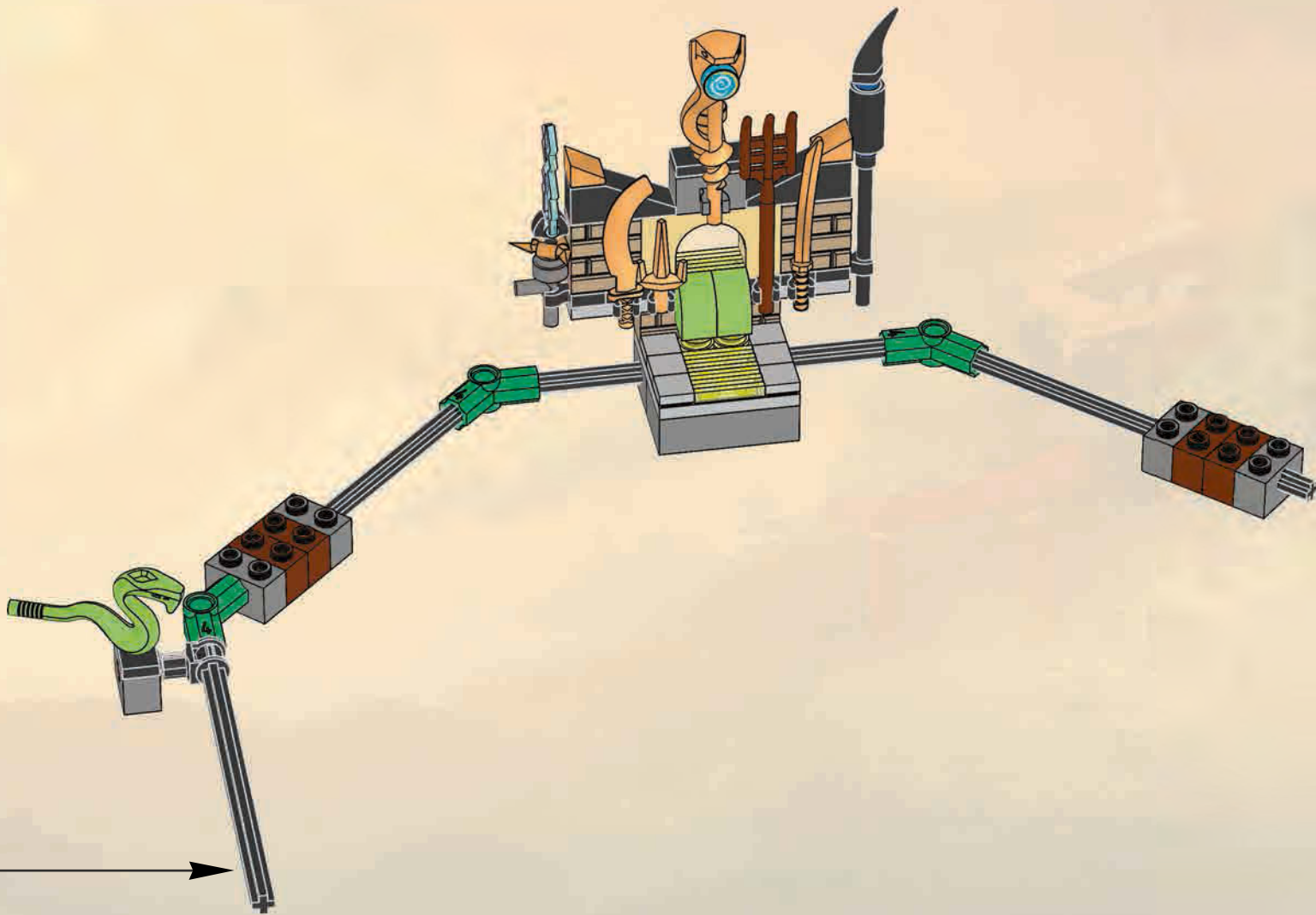

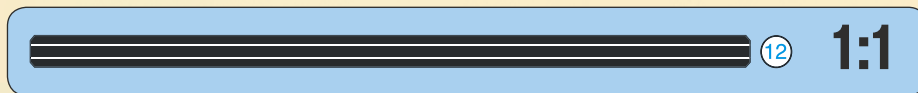
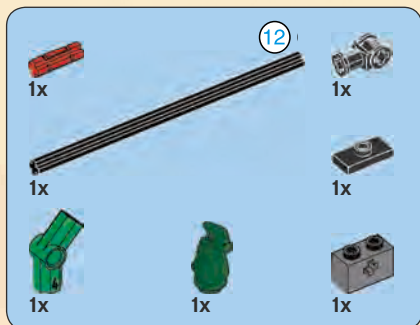

20

1

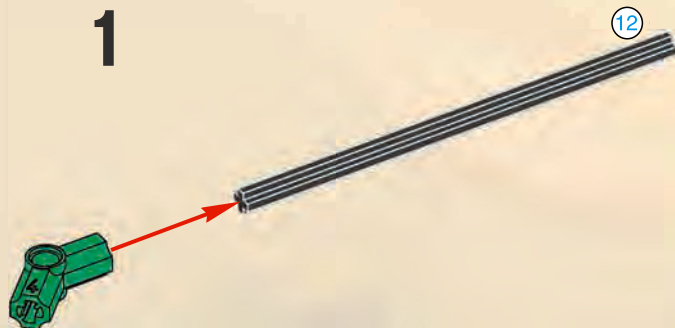

2



16

3



4

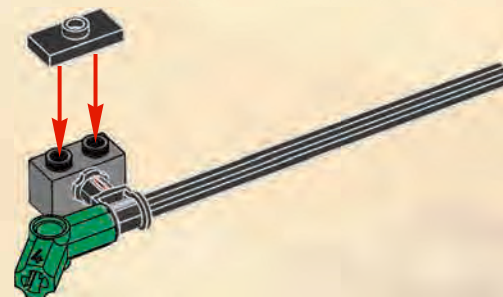

5





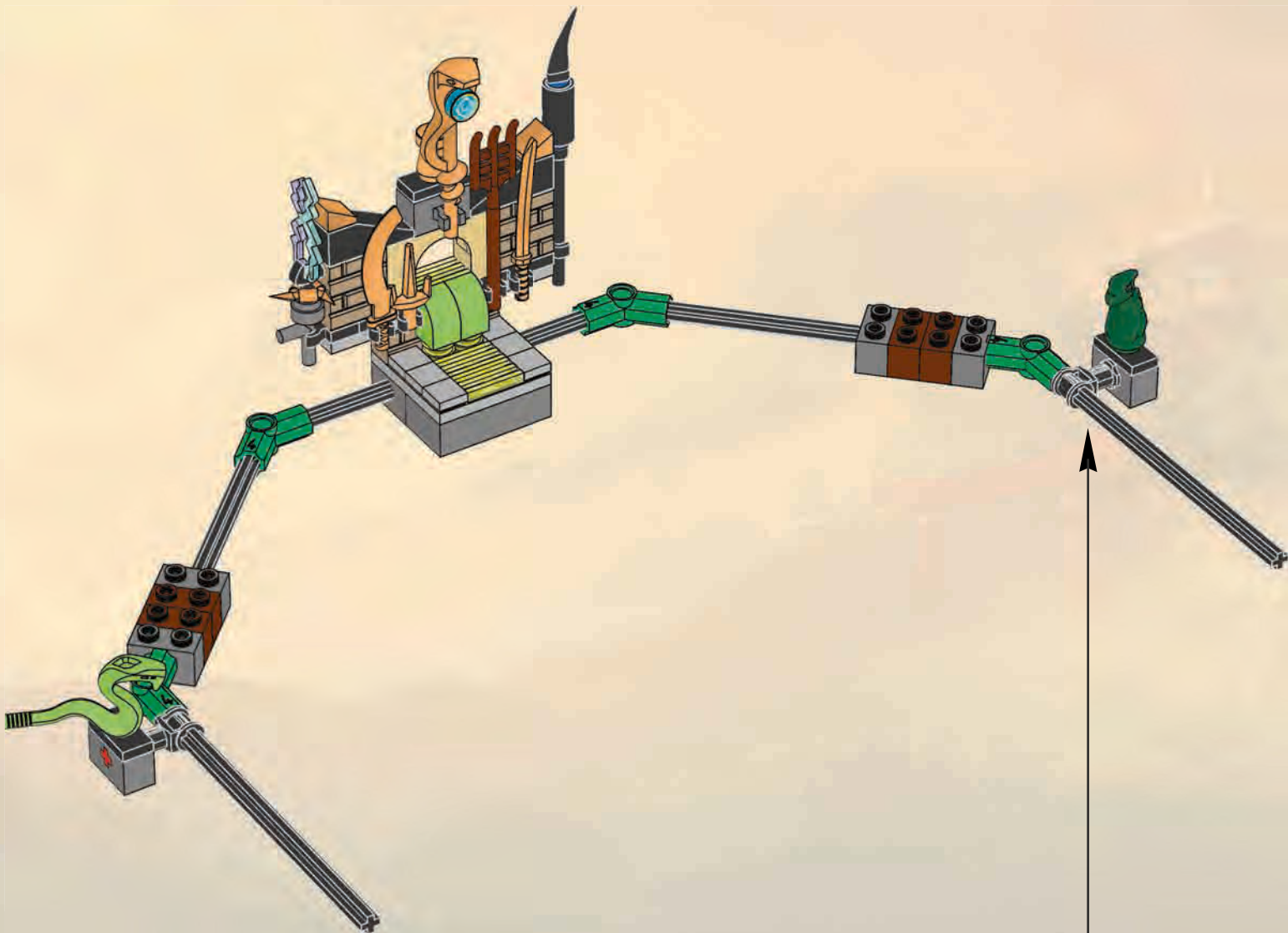

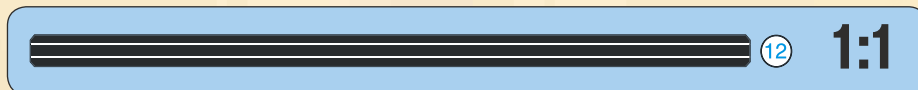
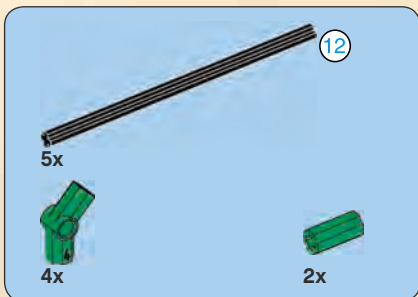

21

1

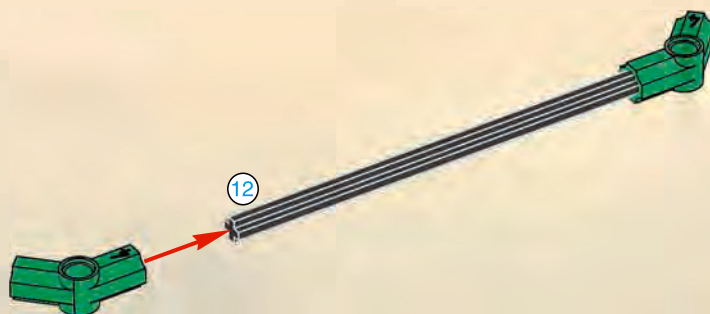



**2**

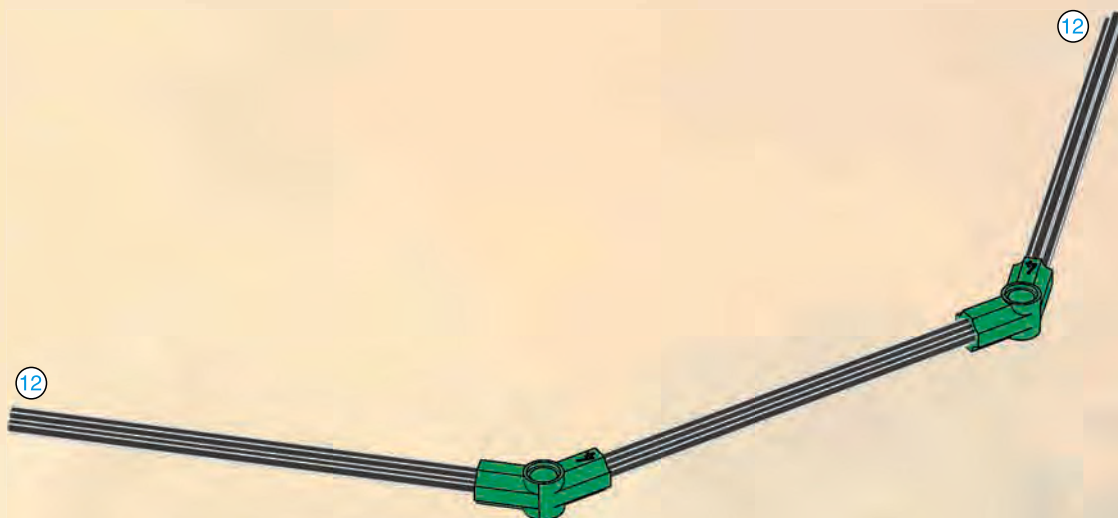

**3**





4

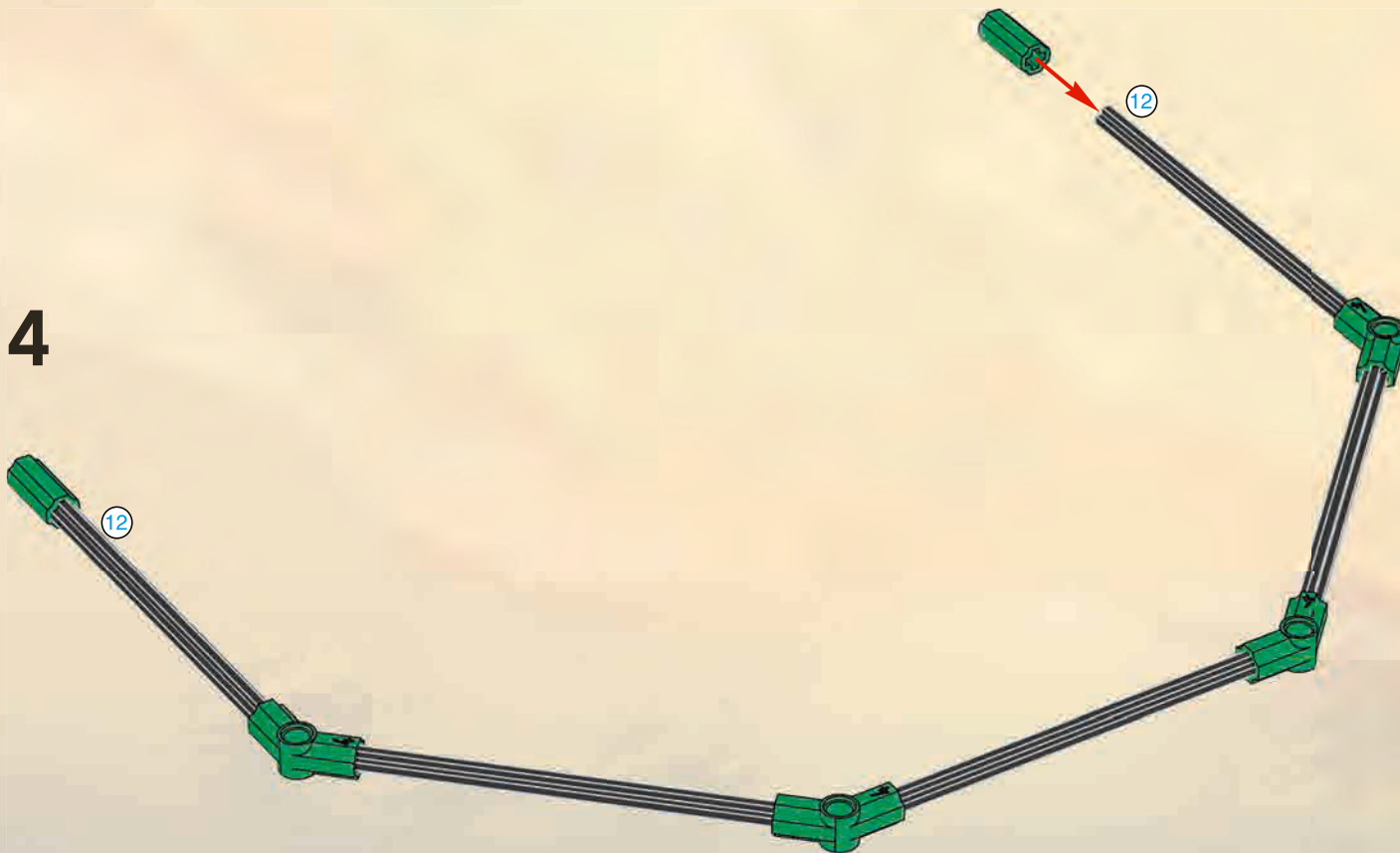

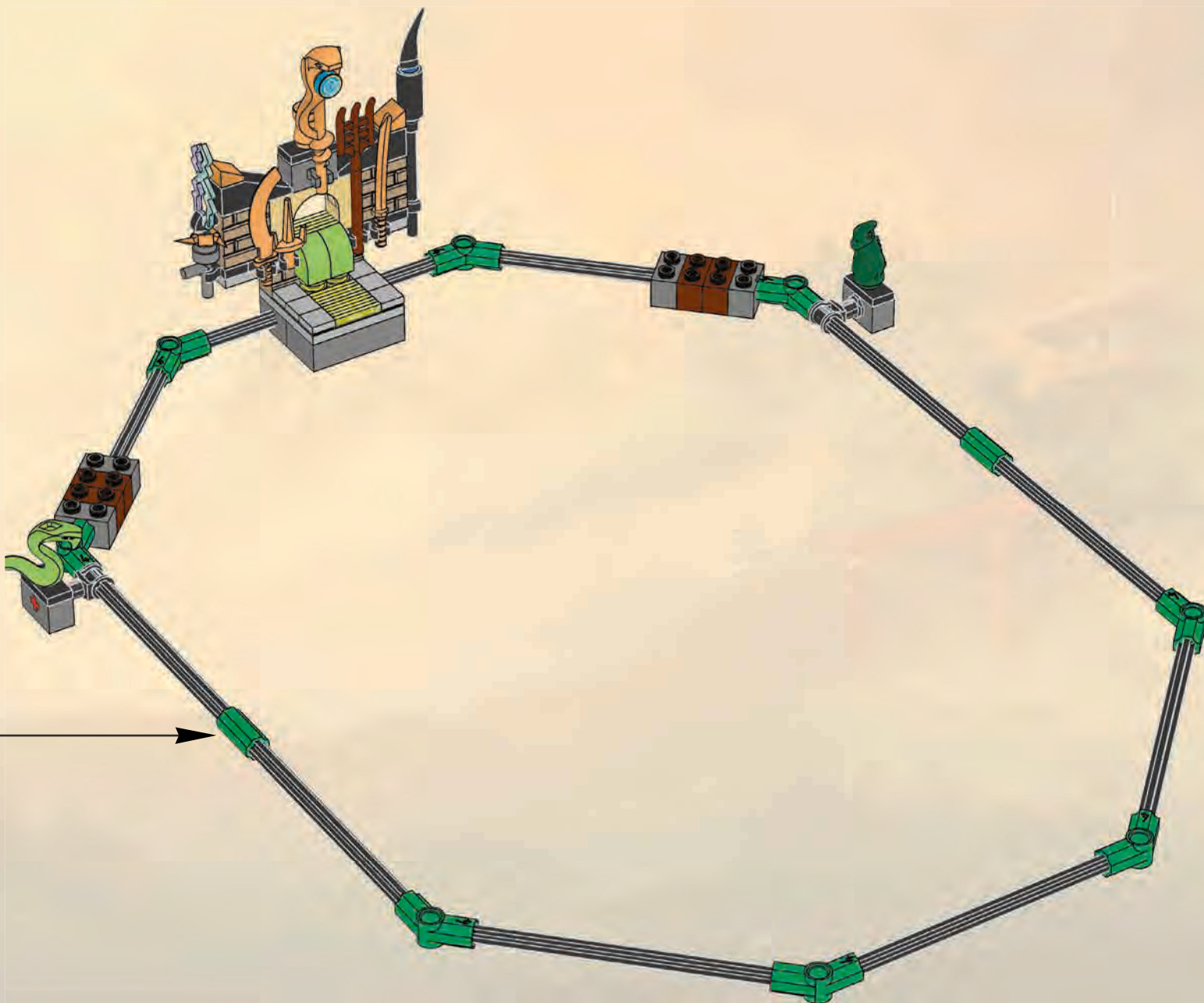

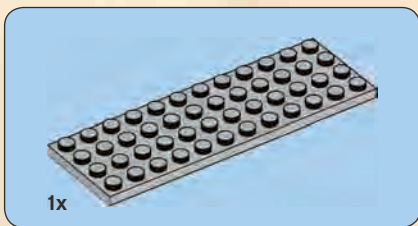
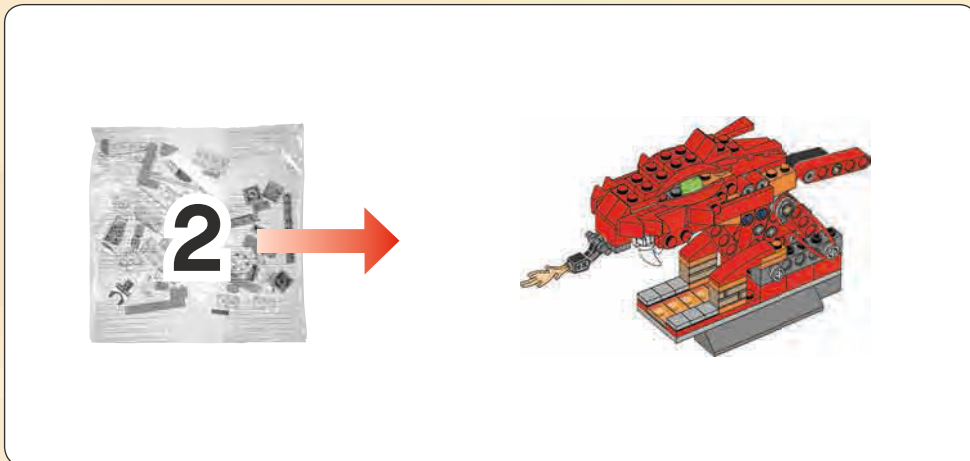

1

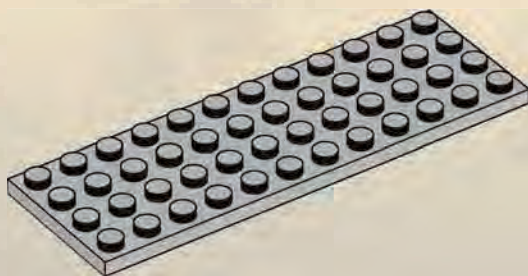

2



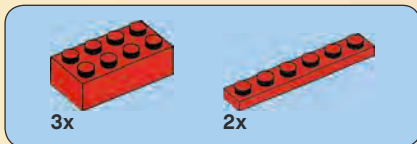

3

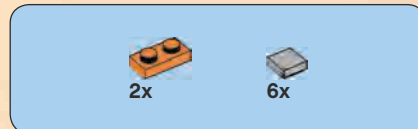
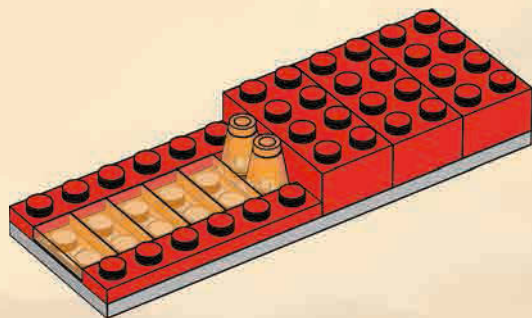

4

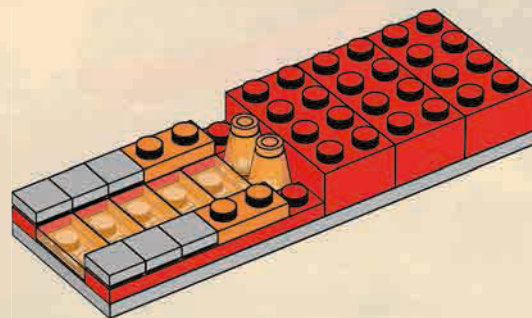

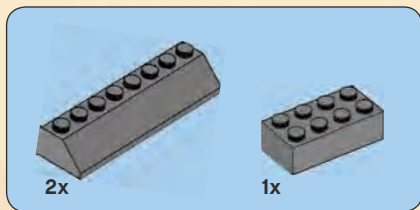

5

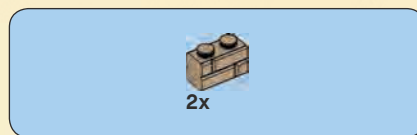
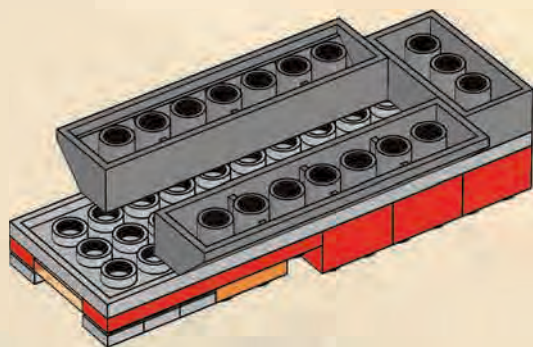
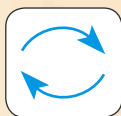

6

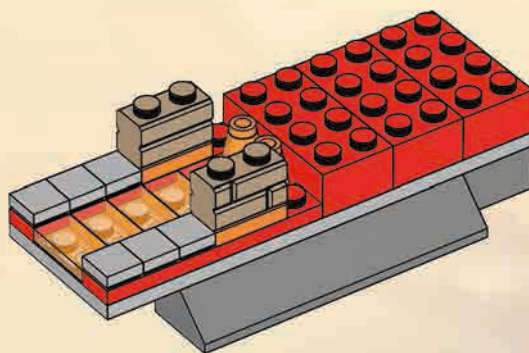
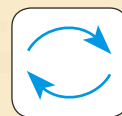





7

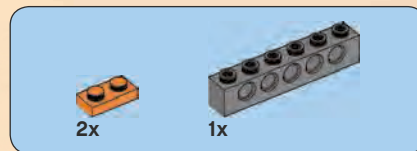
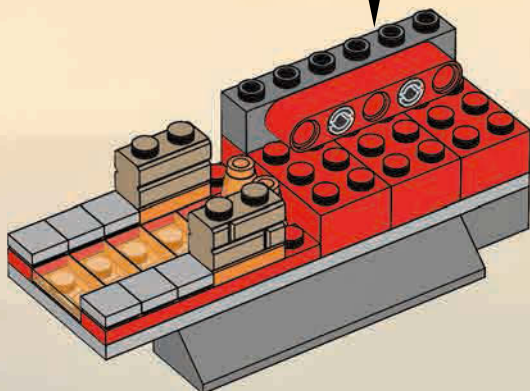
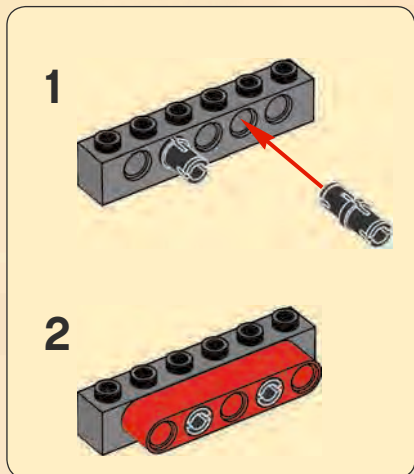

8

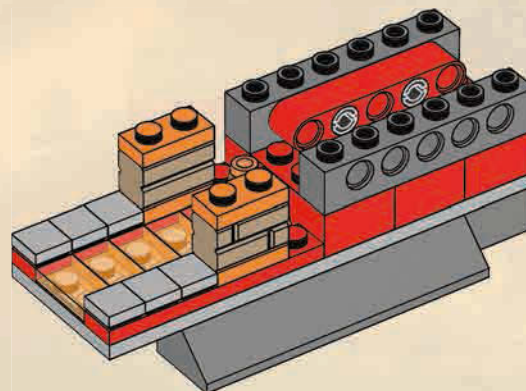



1

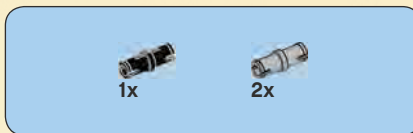
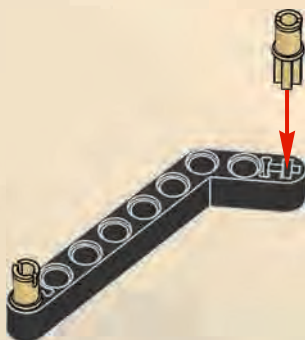

2

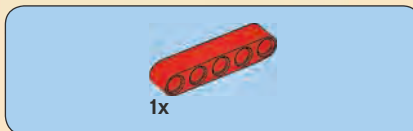

3

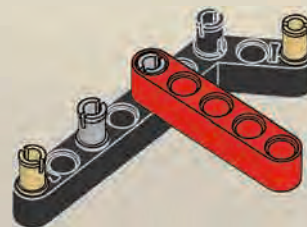

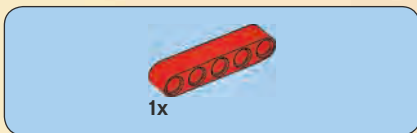

4

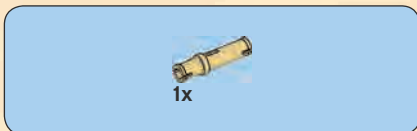

5

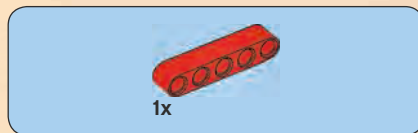
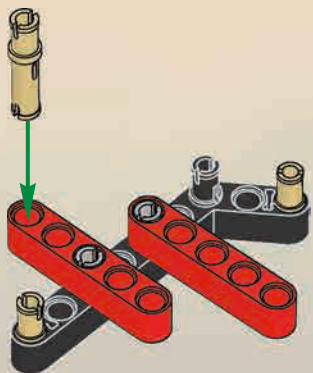

6

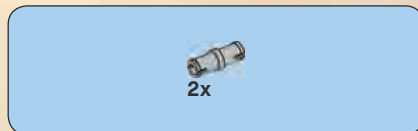

7

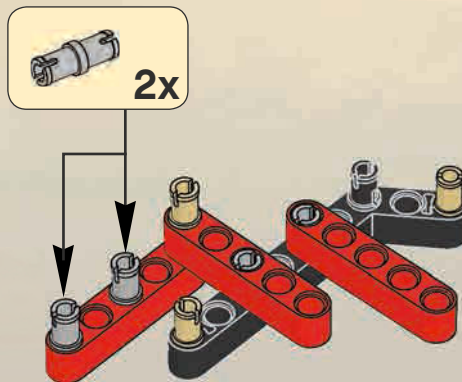

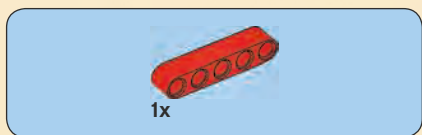

8

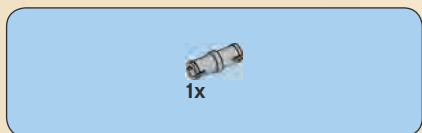
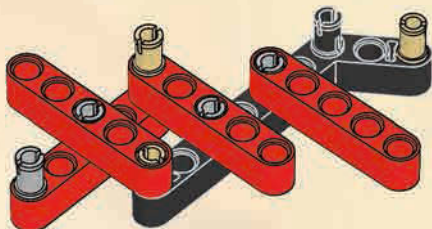

9

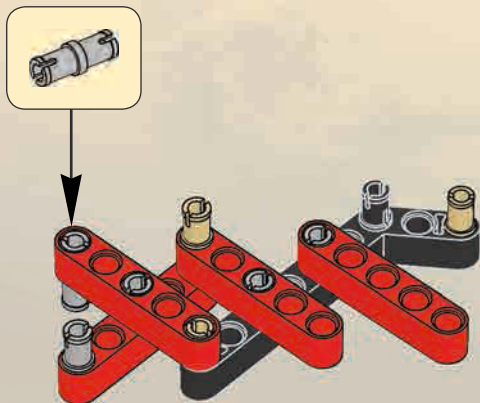

28



10



11





# 12

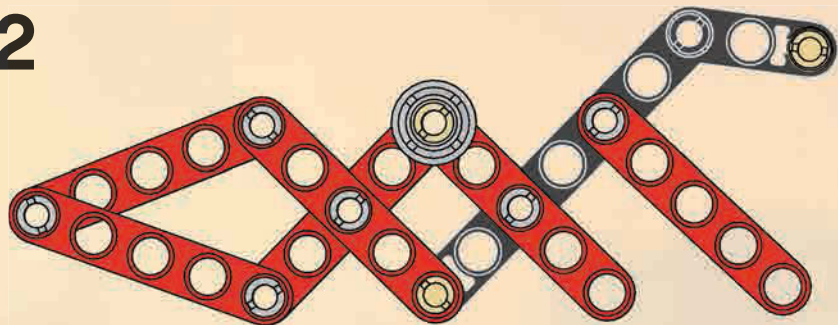

1:1

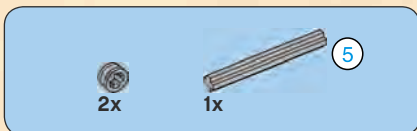

# 13

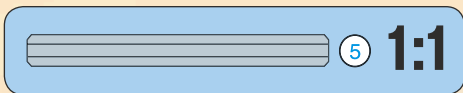

1:1

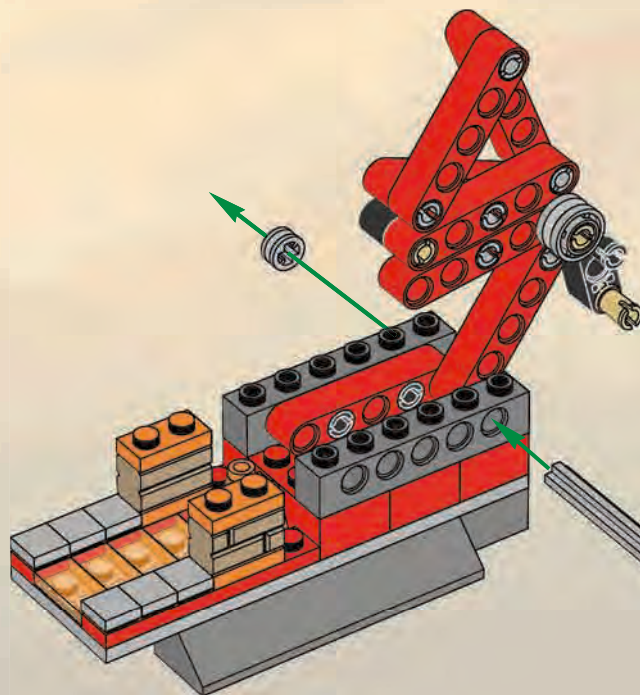

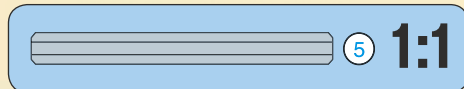
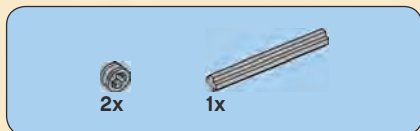

# 14

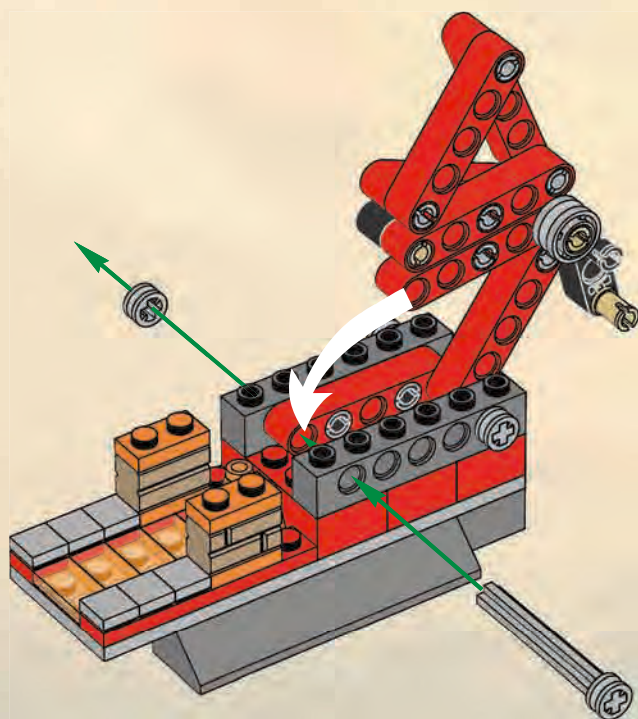

# 15

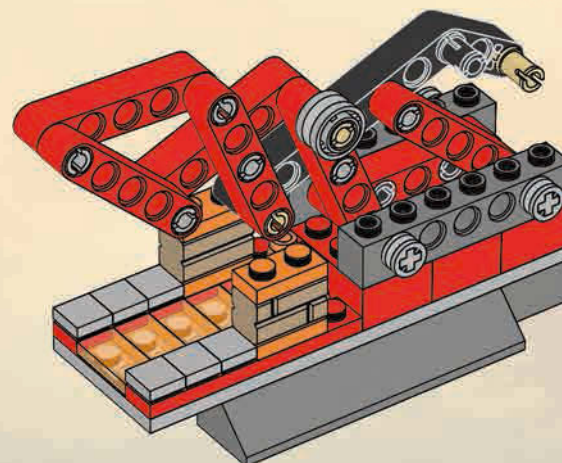

30



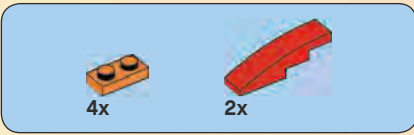

# 16

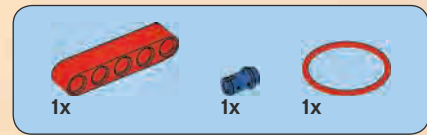
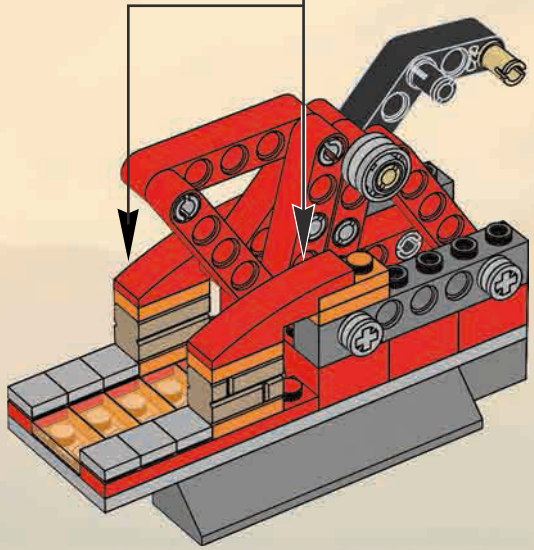
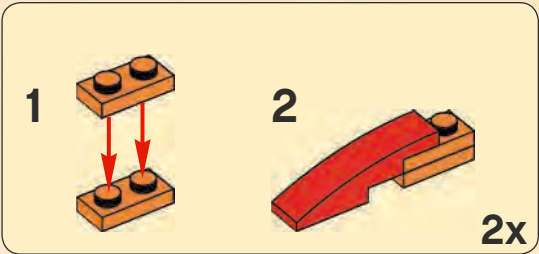

# 17

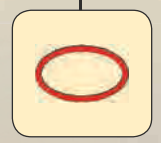
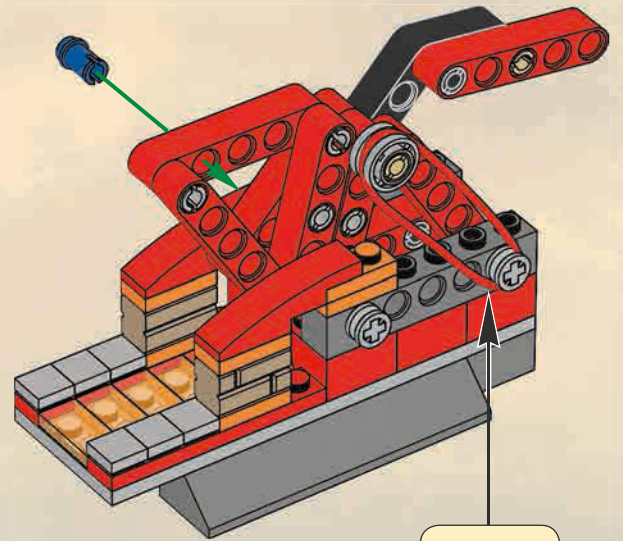

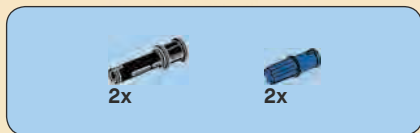

# 18

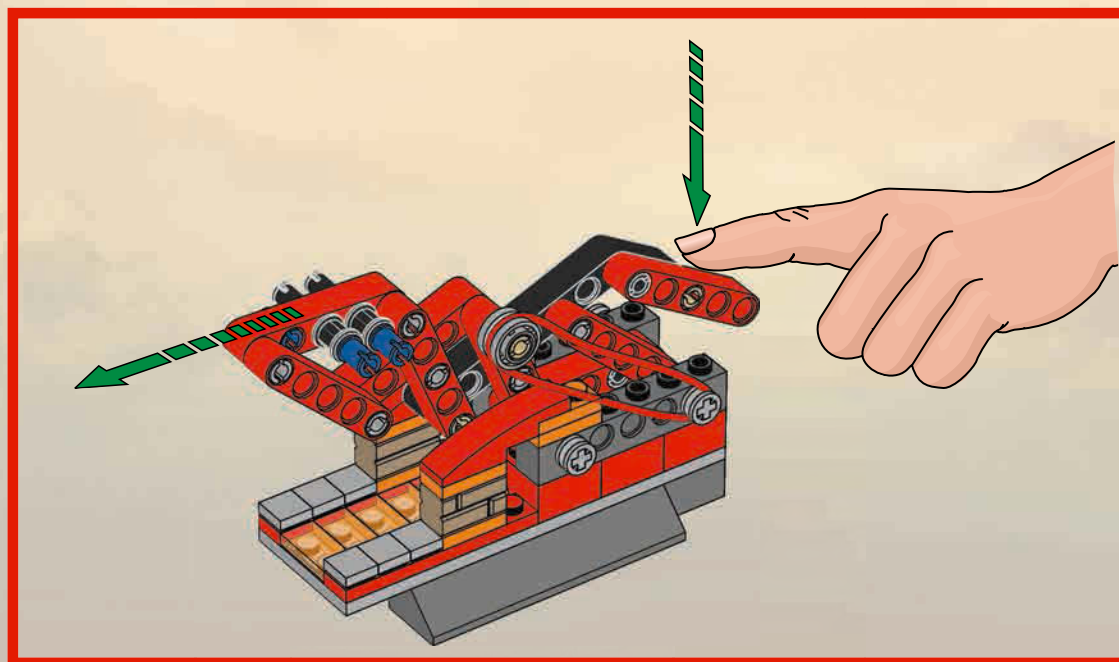
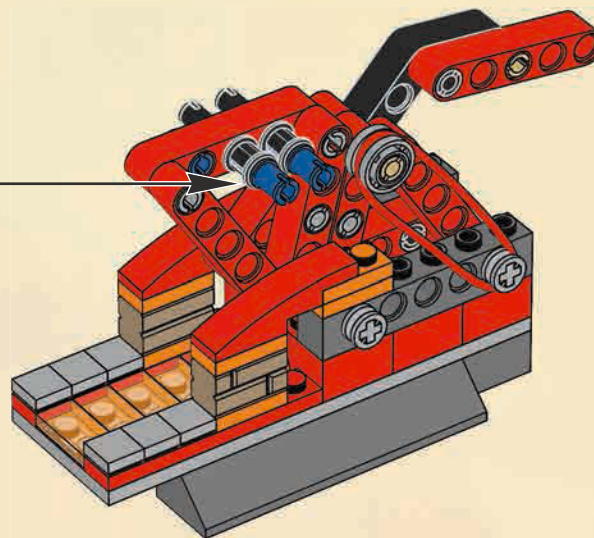
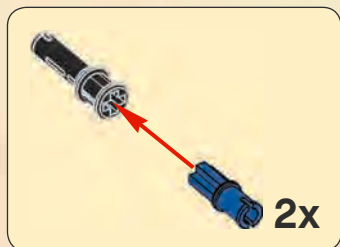

32





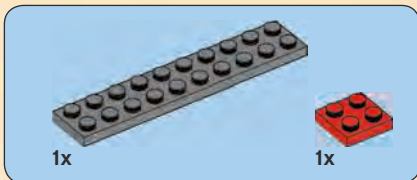
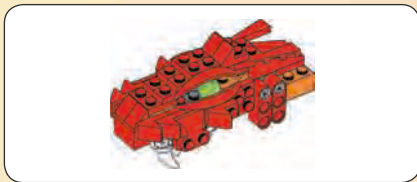

1

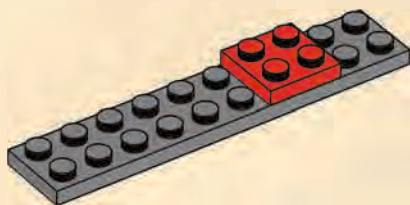

2

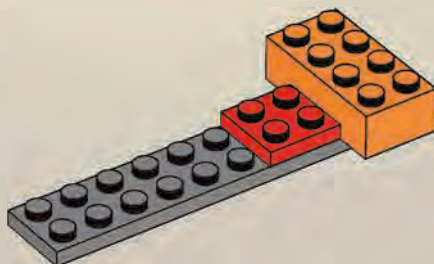

3

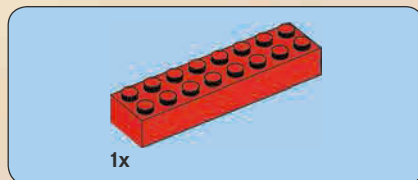
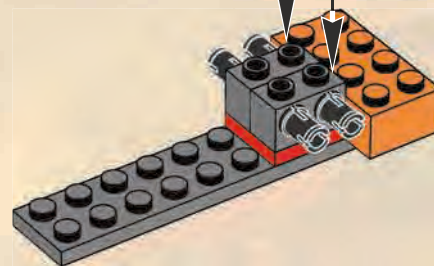
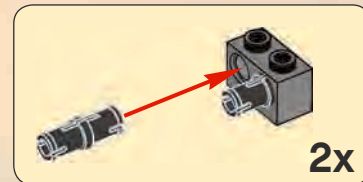

4

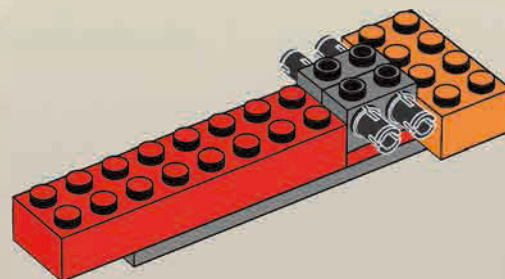



3x



2x

# 5

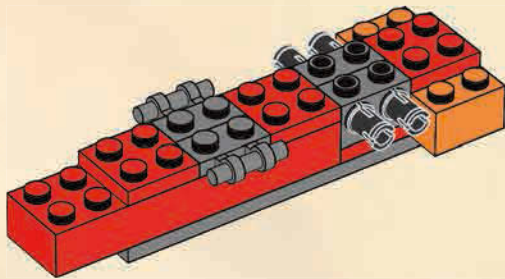

1x



2x

# 6

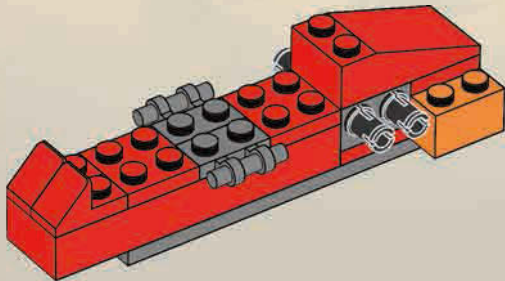

4x

# 7

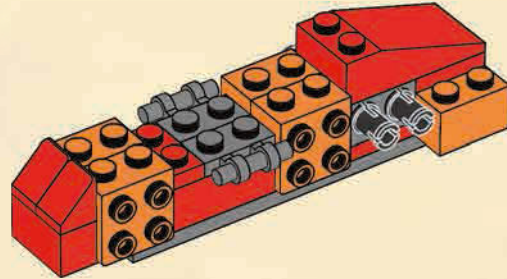

1x



2x



2x

# 8

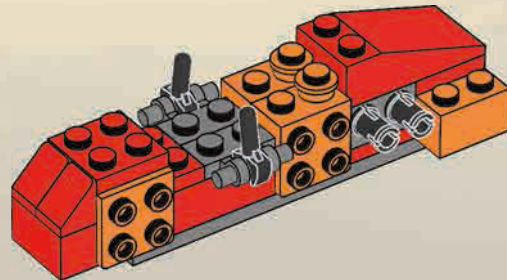



2x

# 9

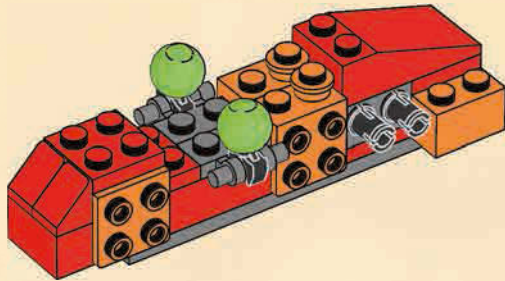

2x

# 10

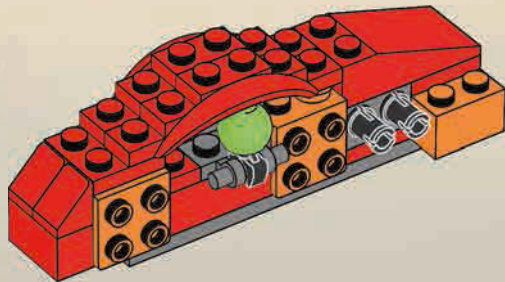

1x

# 11

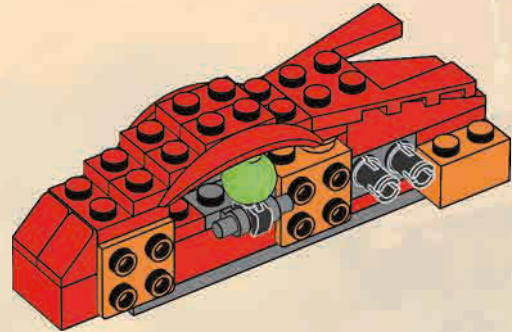

1x



2x

# 12

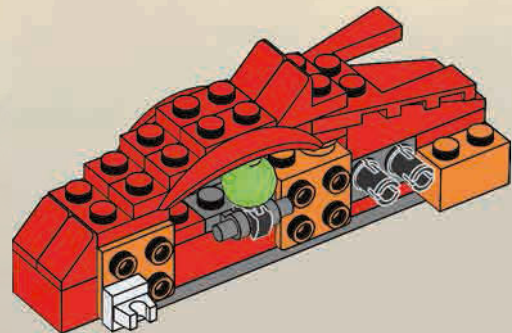



# 13

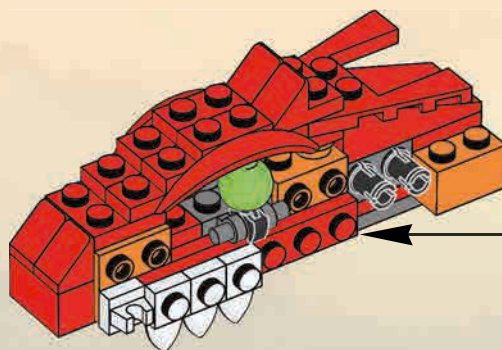
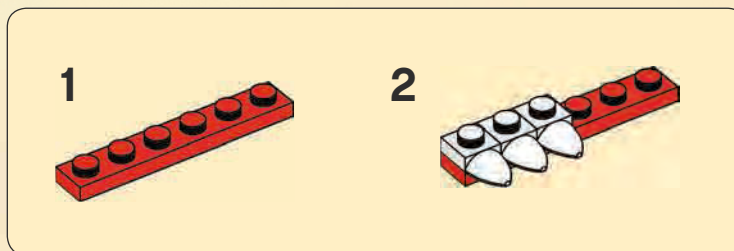



# 14

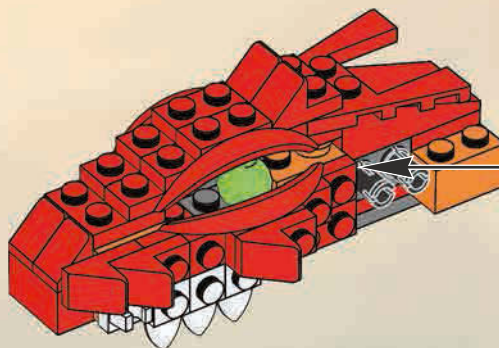
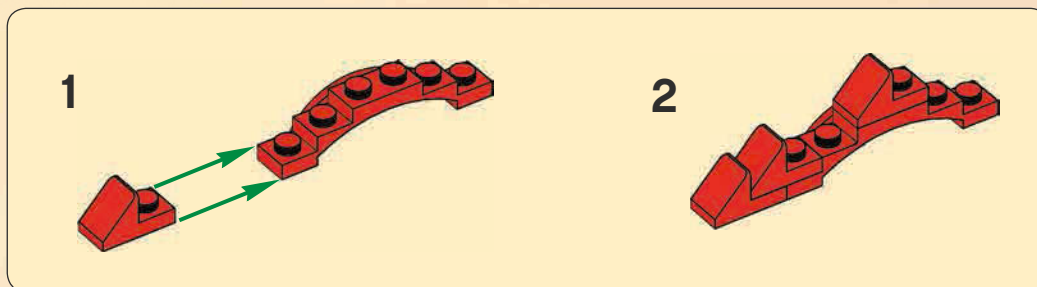



1x

# 15

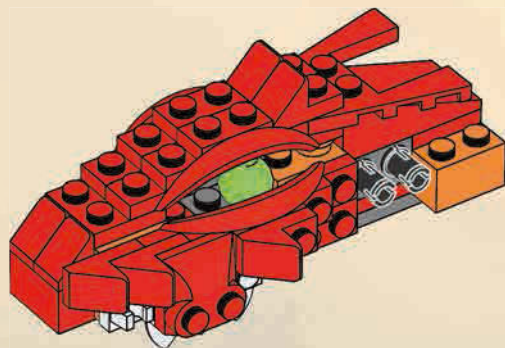

1x

# 16

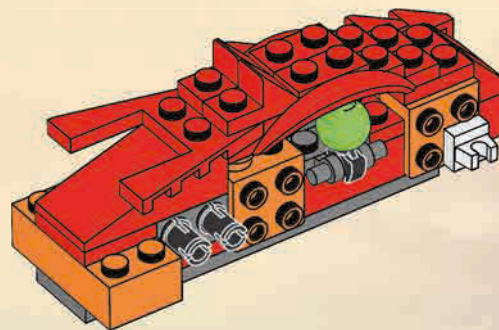
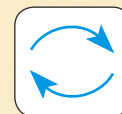



# 17

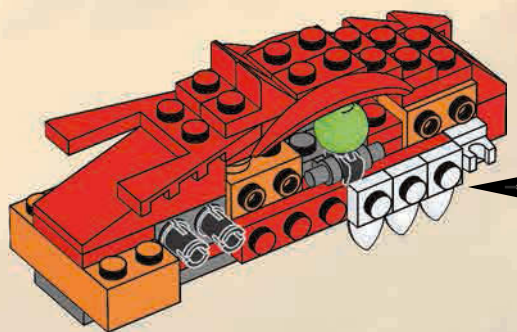
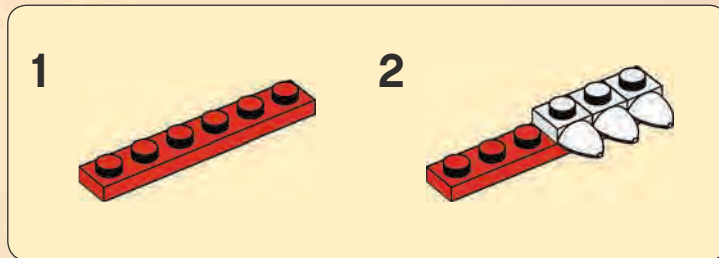



# 18

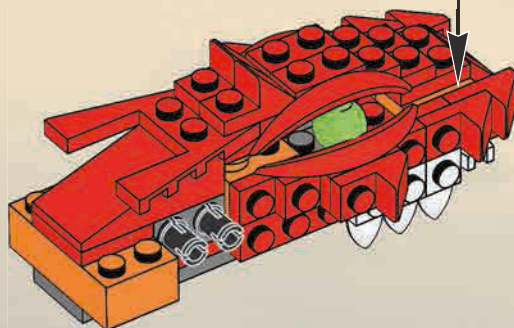
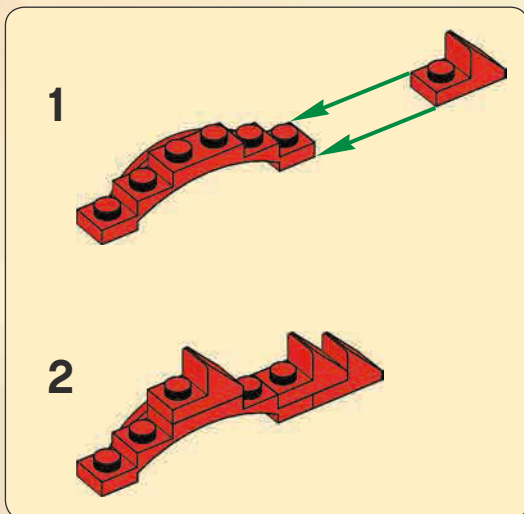

40

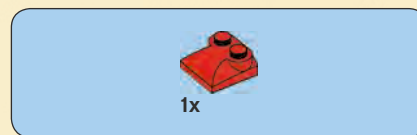

# 19

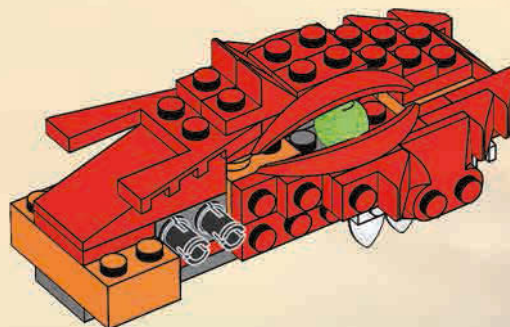





20

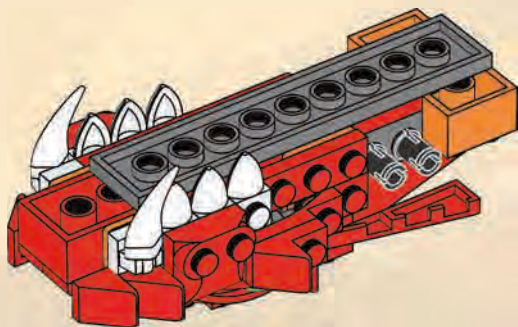
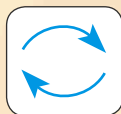

21

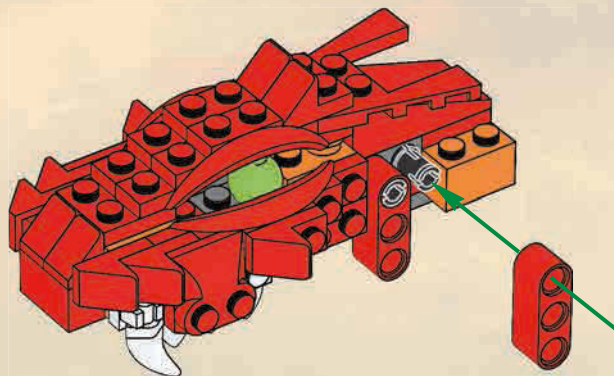
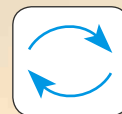



22

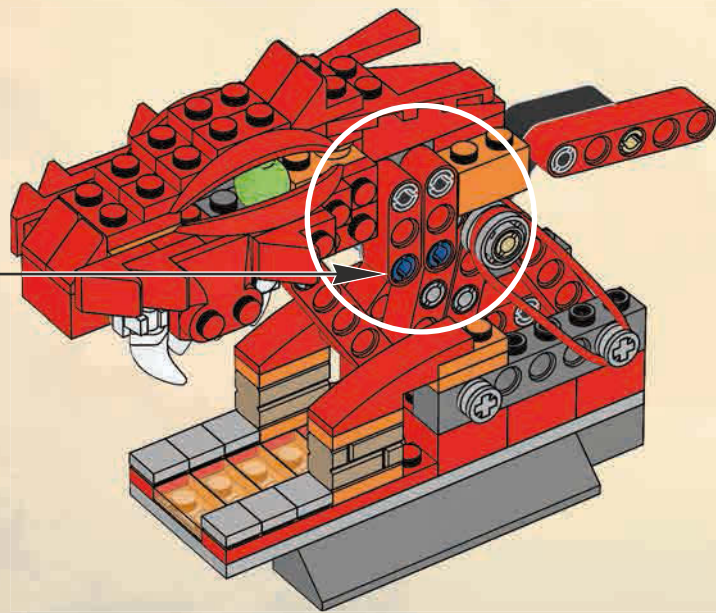



# 23

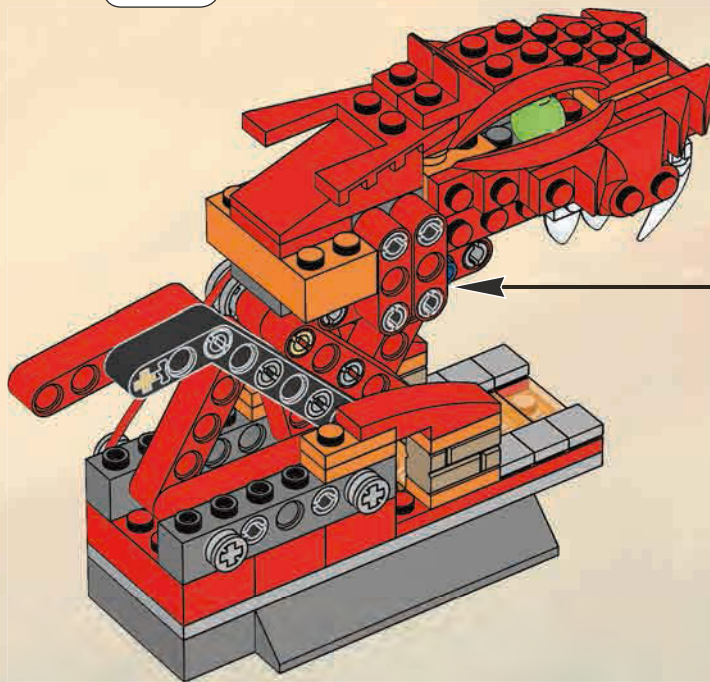
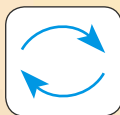

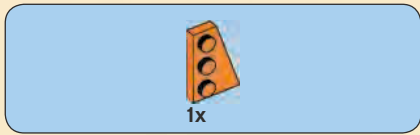

24

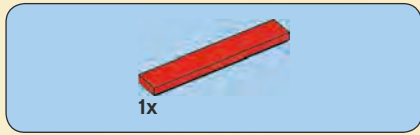
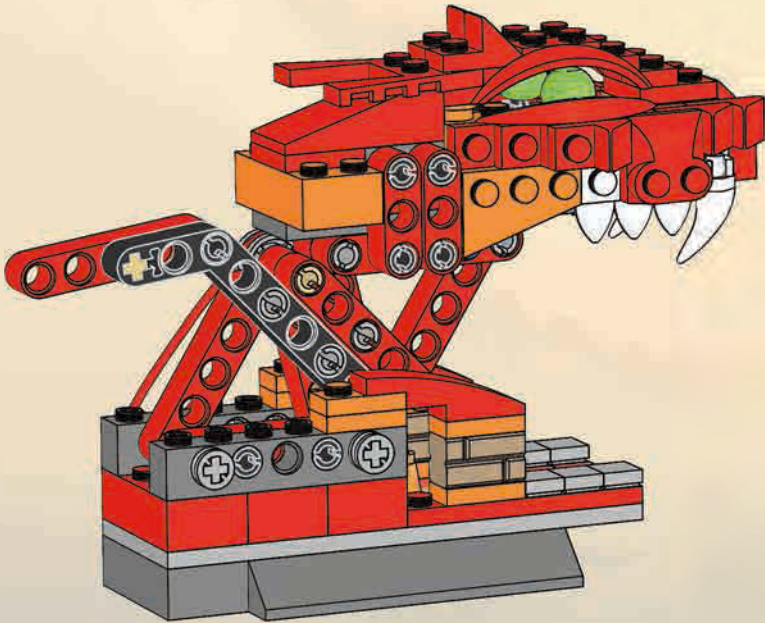

25

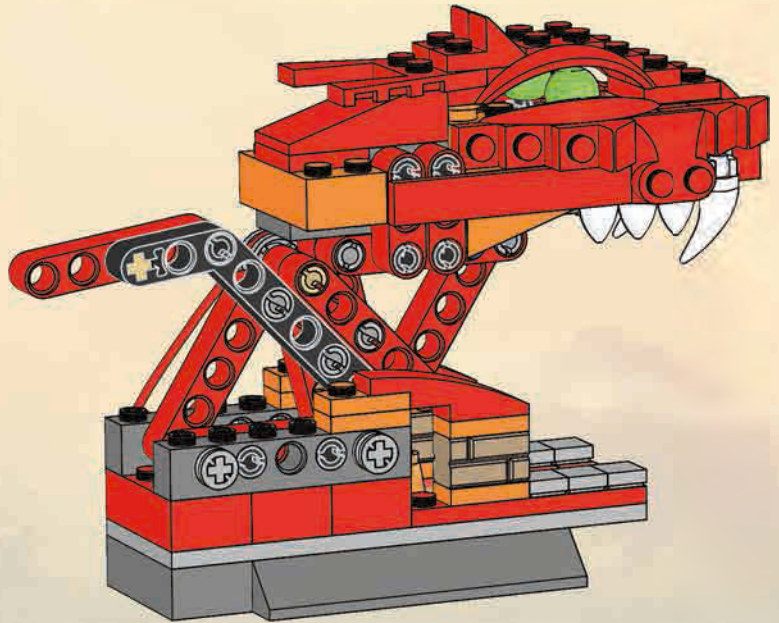



1x

# 26

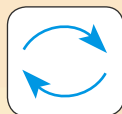

1x

# 27

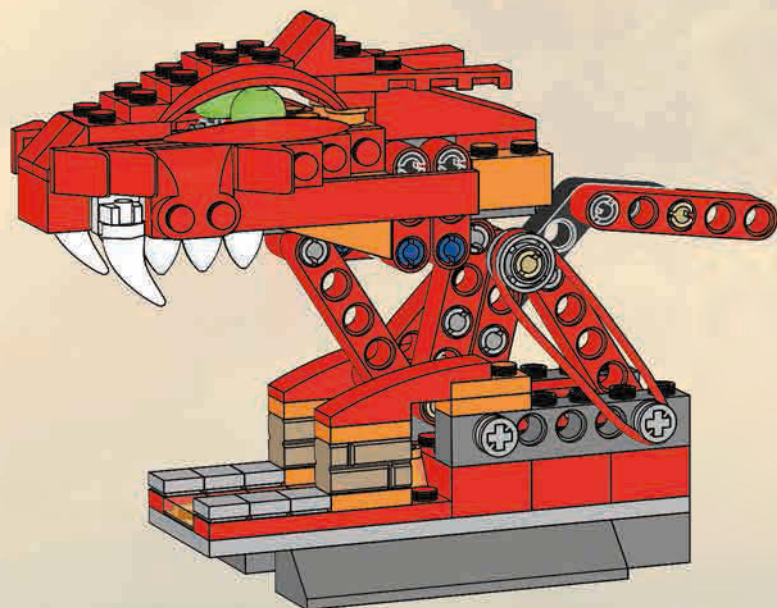

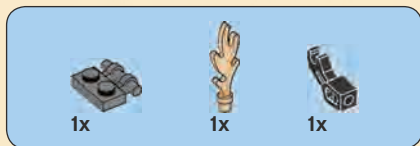

# 28

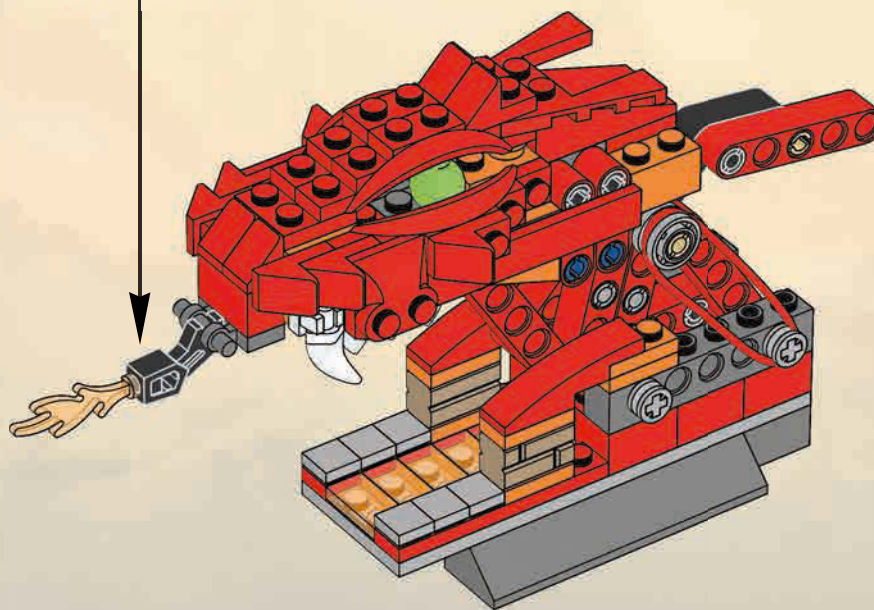

29

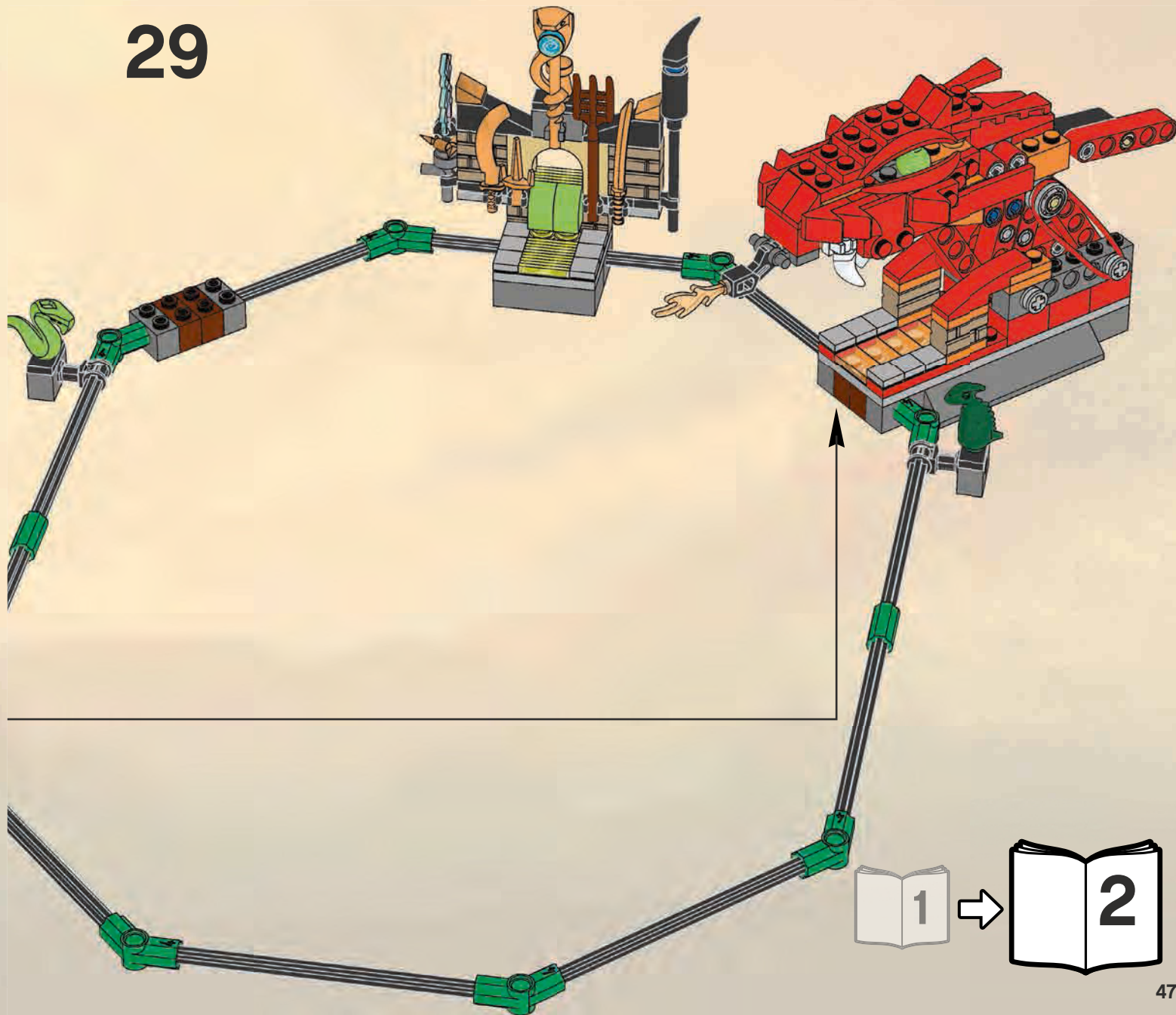

**LEGO club**  
FREE! GRATIS! GRATUIT!



www.LEGOclub.com



LEGO® Club Magazine



LEGO® Club Email

VISIT THE WORLD'S  
BIGGEST LEGO® SHOP!

www.LEGOshop.com

00800 5346 5555



1-866-534-6258 • 1-877-518-5346

US & Canada only

Canada seulement

- \* Freephone. Mobile charges may apply.
- \* Numéros sans frais. Des frais peuvent s'appliquer avec les téléphones cellulaires.
- \* Gebührenfrei, Kosten für Anrufe aus Mobilfunknetzen können abweichen.
- \* Gratis telefonnummer vanaf vaste lijn.
- \* Det er et gratis nummer, når du ringer fra fasttelefon.
- \* Det är gratis, när du ringer från en fast telefon.
- \* Numéro sans frais. Des frais peuvent s'appliquer avec les téléphones portables.



BI115

**YES!** I want to join the LEGO® Club FREE! **OUI!** Je veux m'abonner au LEGO® Club GRATUITEMENT!  
**Ja!** Ich möchte Mitglied im kostenlosen LEGO® Club werden. **Ja!** Ik wil graag GRATIS lid worden van de LEGO® Club.  
**Ja!** Jeg ønsker å melde meg inn i LEGO® Club gratis! **Ja!** Jag vill gå med i LEGO® Club GRATIS!

First name • Prénom  
Vorname • Voornaam  
Fornavn • Förnamn

Last name • Nom de famille  
Name • Achternaam •  
Etternavn • Efternamn

Date of Birth • Date de naissance  
Geburtsdag • Geboortedatum  
Fødselsdato • Födelsedatum

Boy • Garçon •  
Junge • Jongen •  
Gutt • Pojk

Girl • Fille •  
Mädchen • Meisje  
Jente • Flicka

Street • Adresse  
Straße, Hausnr.  
Straat, huisnr. • Adress

City • Ville  
Ort • Woonplaats  
Poststed • Postort

State  
Prov. County

Zip/Postcode  
Code Postal • PLZ  
Postcode  
Postnummer

Country  
Pays Land

Email • Courriel  
E-Mail • E-post

- Fill in your email address and we will send you a membership confirmation and monthly email newsletters. If you do not wish to receive the newsletters please tick here. Remplis ton adresse e-mail et nous t'envoyons une confirmation d'adhésion ainsi que le bulletin e-mail mensuel. Si tu ne désires pas recevoir le bulletin, coche cette case. Vul je e-mailadres in en we sturen je een bevestiging van je lidmaatschap en maandelijke e-mail nieuwsbrieven. Als je geen e-mail wilt ontvangen, kruis dan dit vakje aan.
- Ich möchte per E-Mail den monatlichen LEGO Club Newsletter erhalten. Ønsker du at vi skal sende en liten hilsen til barnet ditt for å bekrefte medlemskapet, ber vi deg kryss av i feltet, samt oppgi e-postadressen som hilsenen skal sendes til. Om du vill att vi ska skicka en bekräftelse på ditt barns medlemskap, ber vi dig sätta ett kryss i rutan och skriva den e-post adress som bekräftelsen ska skickas till.
- If you do not wish to receive additional mailings from the LEGO Club please tick here. Si tu ne désires pas recevoir de courrier supplémentaire du Club LEGO, coche cette case. Als je geen verdere post van de LEGO Club wilt ontvangen, kruis dan dit vakje aan.
- Dersom du ønsker å motta annen informasjon fra LEGO Gruppen, setter du et kryss her.

Mail to: / Poster à: **LEGO® Club**  
P.O. Box 1157  
Enfield, CT USA  
06083-1157

Per Post an: **LEGO® Club**  
Postfach 14 15  
D-36243 Niederaula

Send til: **LEGO® Club Norge**  
Postboks 58  
1314 Vøyenenga

Mail to: **LEGO® Club**  
33 Bath Road  
Slough SL1 3UF  
United Kingdom

Stuur op naar: **LEGO® Club**  
Postbus 40250  
3504 AB Utrecht

Skickas till: **LEGO® Club Sverige**  
Ubox 841  
202 29 Malmö

Poster à: **LEGO® Club**  
21 rue de la banque  
75 002 PARIS  
FRANCE

The English language version of the magazine can only be mailed to addresses in the US, Canada, the UK, and Republic of Ireland. Club membership is valid for two years and includes free copies of the LEGO Club Magazine and e-mail newsletters. In the US and Canada please allow up to 6 weeks for delivery of your first magazine. In the UK and Republic of Ireland please allow six to 14 weeks for delivery of your first magazine. By signing this form you consent the LEGO Club to use your child's data for LEGO mailings. The data will only be used for LEGO mailings and will not be sold, rented or otherwise disclosed to any company outside the LEGO Company except for companies acting as our agents to help us provide services requested by the child. This coupon is valid for one free membership per person, group or organization. Photocopied coupons are accepted. La version française du magazine peut être postée uniquement au Canada. L'abonnement est valide pour 2 ans et inclut des exemplaires gratuits du Magazine LEGO Aux E U et au Canada, aller 6 semaines pour la livraison initiale. En remplissant ce formulaire, vous consentez à ce que LEGO utilise les informations de votre enfant pour des envois postaux de LEGO. L'information sera utilisée uniquement pour des envois postaux par LEGO et ne sera en aucun cas, vendue, louée, échangée ou divulguée à d'autres compagnies autres que la compagnie LEGO, à l'exception des compagnies affiliées qui nous procurent des services auxquels l'enfant ou à fait la demande. Formulaire photocopiés acceptés. Mit der folgenden Unterschrift erteile ich, für mein Kind den Beitritt als Mitglied zum kostenlosen LEGO Club, der von der LEGO GmbH, D-85627 Grasbrunn, betrieben wird. Die Mitgliedschaft beinhaltet die Zusendung des LEGO Club Magazins und kann beiderseits jederzeit beendet werden. Mit der Mitgliedschaft im LEGO Club sind keinerlei Verpflichtungen verbunden. Das deutschsprachige LEGO Club Magazin wird nur an Adressen in Deutschland, Österreich und der Schweiz versendet. Eine Anmeldebestätigung kann nur per E-Mail geschickt werden. Das Magazin erscheint fünfmal jährlich. Daher kann die Zustellung des ersten Heftes bis zu drei Monate dauern. Die Mitgliedschaft ist beiderseitig jederzeit kündbar, ohne dass Ihnen Kosten entstehen. Sie können der werblichen Nutzung Ihrer Daten jederzeit widersprechen. Kündigung und Widerspruch können Sie telefonisch erklären (00800) 5346 5555, Anruf gebührenfrei, Kosten für Anrufe aus dem Mobilfunknetz können abweichen oder an die LEGO Club Magazine. Ved å undertegne dette skjemaet, gir du ditt samtykke til at LEGO Club kan bruke opplysningene om barnet ditt i LEGO forsendelser. Dataene vil utelukkende bli brukt i LEGO forsendelser og vil ikke bli solgt, utleid eller på annen måte gjøres tilgjengelig for selskaper utenfor LEGO gruppen, unntatt selskaper som er våre agenter og som hjelper oss å tilby tjenestene barnet ettertar. Dette skje mået gjelder for ett gratis medlemskap per person, gruppe eller organisasjon. Den svenske versionen av tidsningen kan endast skickas till adresser i Sverige. Club medlemskapet är giltigt i 2 år och innefattar gratis exemplar av LEGO Club Magazine. Vånligen räkna med minimum 6 veckor för leverans av din första tidning. Genom att skicka in ditt här formuläret godkänner du att LEGO Club använder barnets uppgifter för LEGO utskick. Uppgifterna kommer bara att användas för LEGO utskick och kommer inte att säljas, hyras ut eller vidarebefordras till något företag som inte tillhör LEGO Gruppen, med undantag av företag som agerar som våra ombud för att tillhandahålla tjänster som barnet har begärt. Den här kupongen gäller för ett gratis medlemskap per person, grupp eller organisation. En complétant ce bulletin d'adhésion, vous acceptez que LEGO Club utilise les données relatives à votre enfant pour l'envoi de courriers concernant LEGO. Ces données seront uniquement utilisées pour l'envoi d'information concernant LEGO et ne seront ni vendues, ni louées, ni cédées par d'autres sociétés que le groupe LEGO, à l'exception des sociétés agissant pour le compte de LEGO en tant que sous-traitant de services divers. L'abonnement au LEGO Club est valable pour une période de 2 ans. Il inclut l'envoi par courrier du magazine LEGO Club et par email des newsletters. Un délai de 6 à 14 semaines est à prévoir pour la réception de votre premier magazine. Ce bulletin d'adhésion gratuit est valable pour l'inscription d'une seule personne. Les photocopies sont acceptées. ATTENTION! Le bulletin d'adhésion doit être rempli et signé par un parent ou un tuteur.

Parent's signature • Signature d'un parent ou d'un tuteur •  
Unterschrift Erziehungsberechtigte(r) • Handtekening ouders •  
Foreldres/foresatters underskrift • Föräldras/foormyndares underskrift

Date  
Datum  
Date

LEGO and the LEGO logo are trademarks of the/ont des marques de commerce de/son marcas registradas de LEGO Group. ©2012 The LEGO Group. 6002474