



# NINJAGO

Masters of Spinjitzu



9457



1

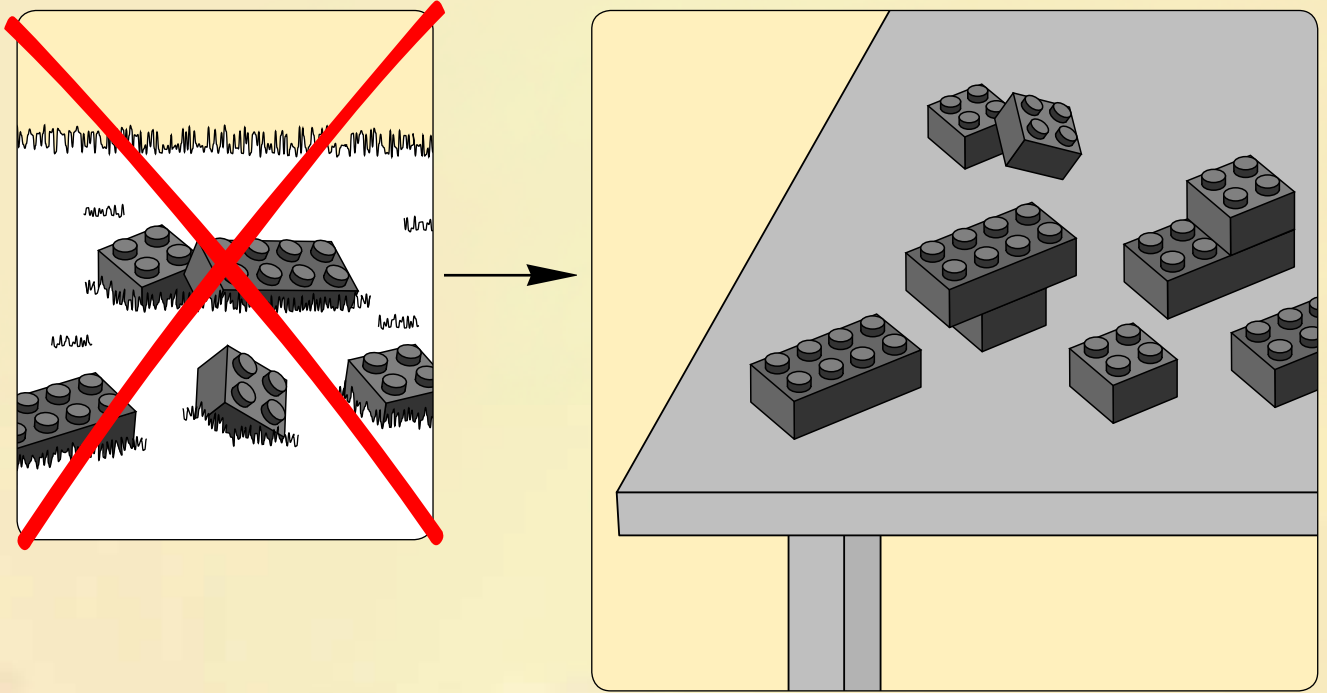

2





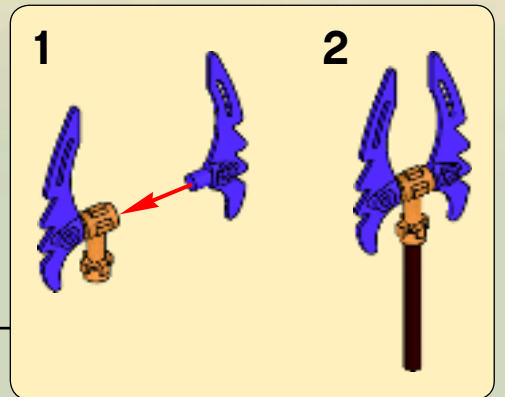
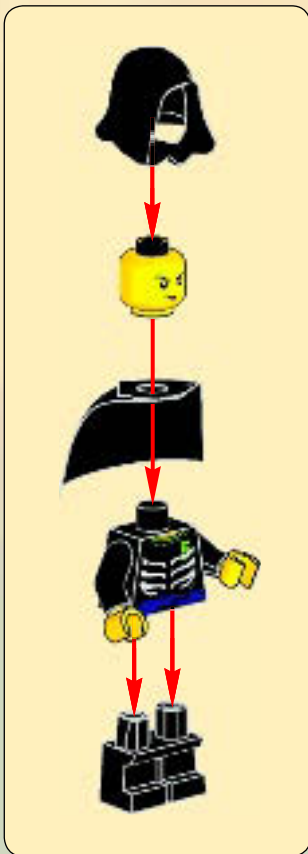
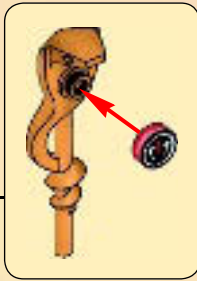
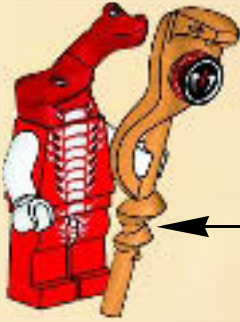
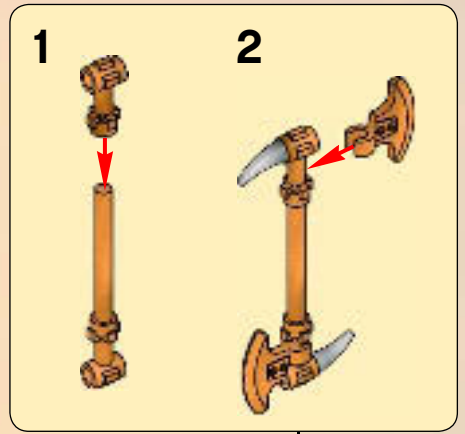
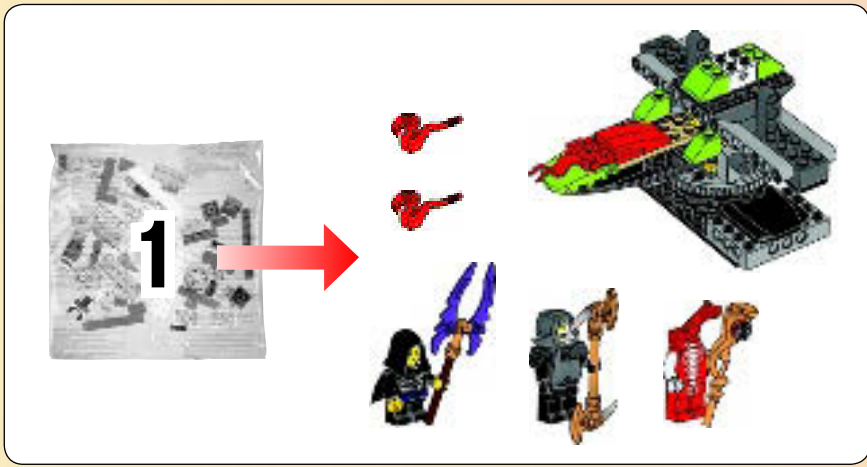

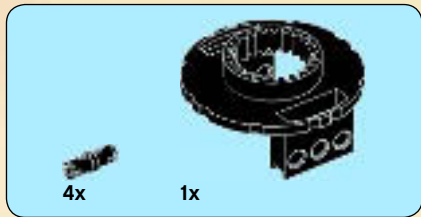

1

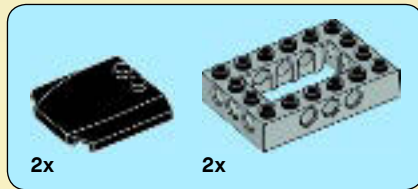
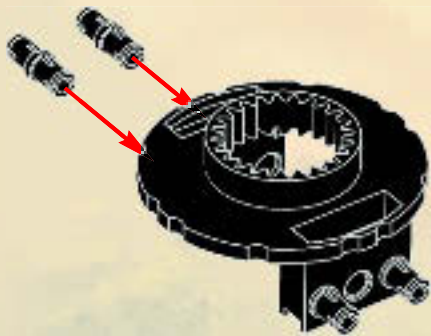

2

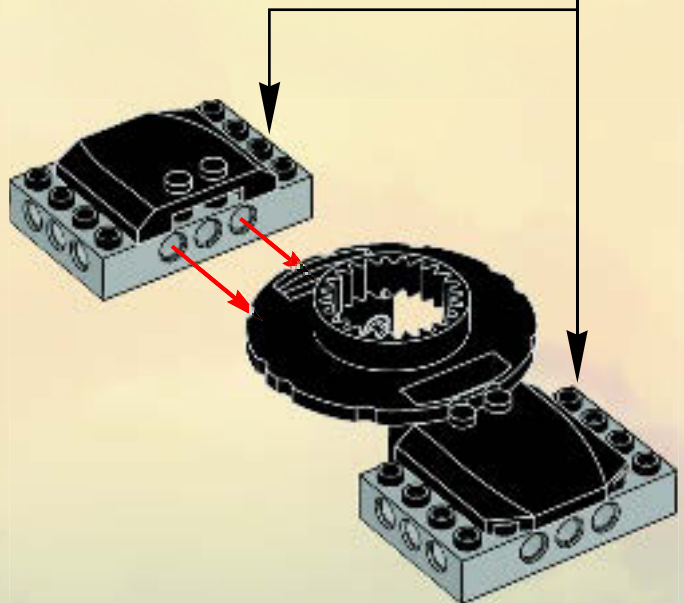
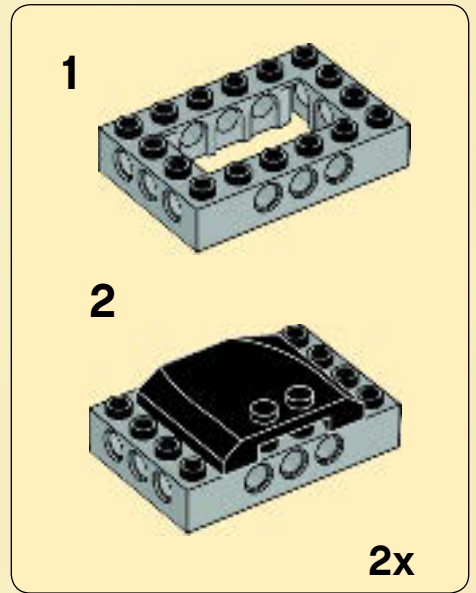





3

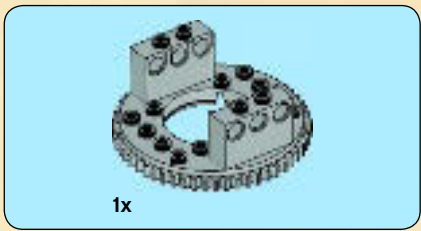
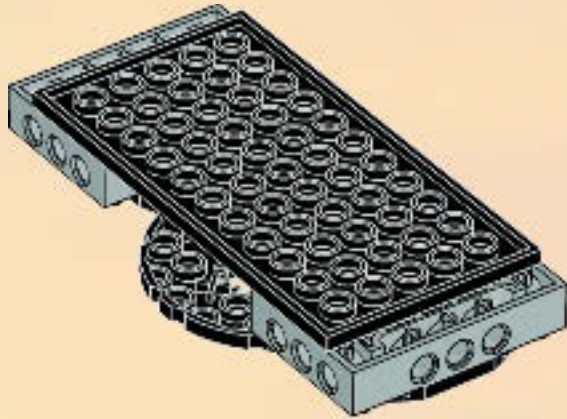
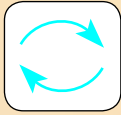

4

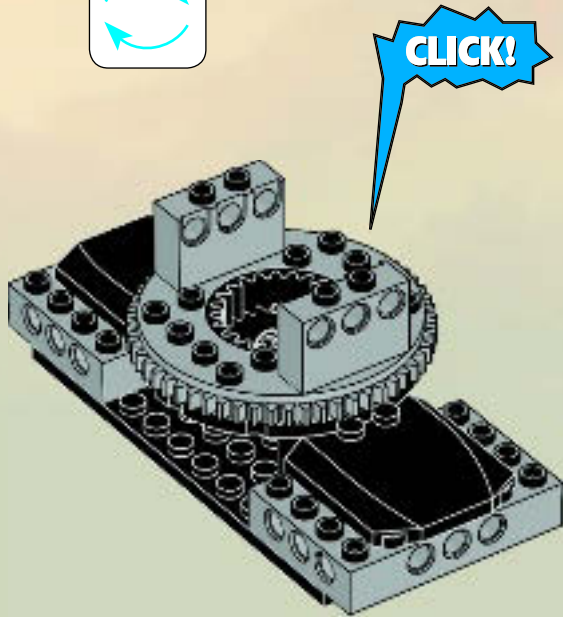
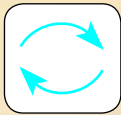

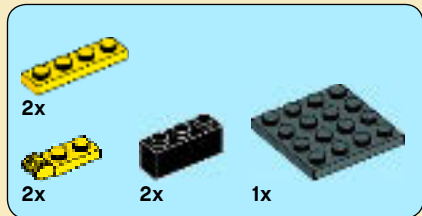

# 5

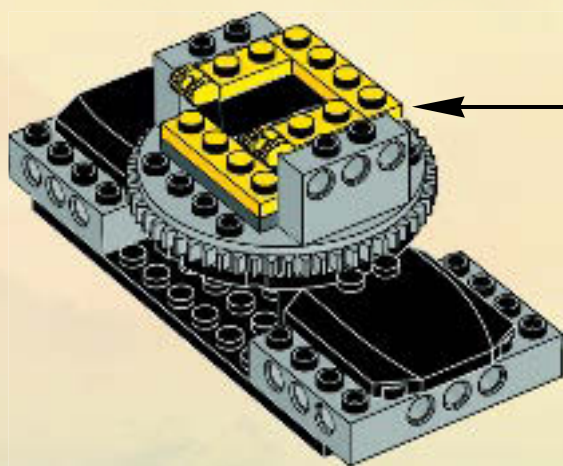
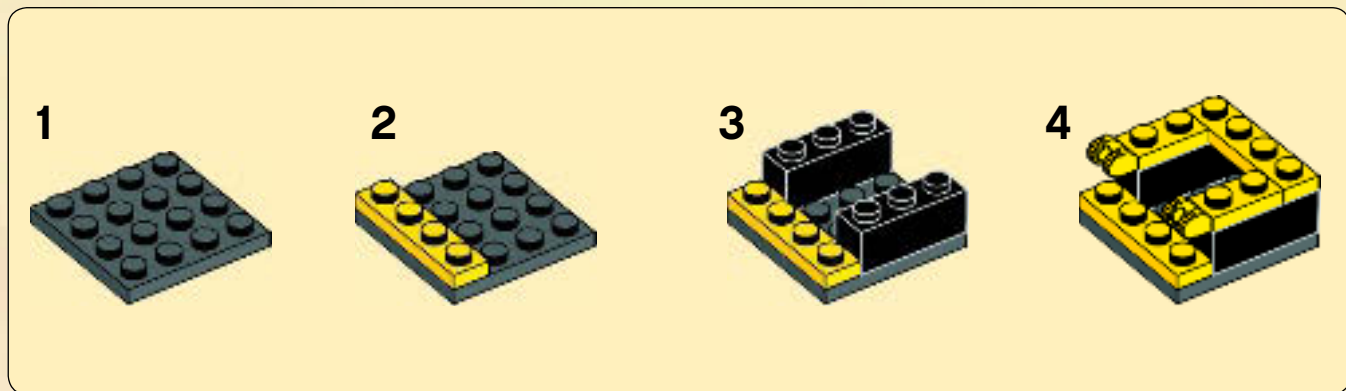





4x

6

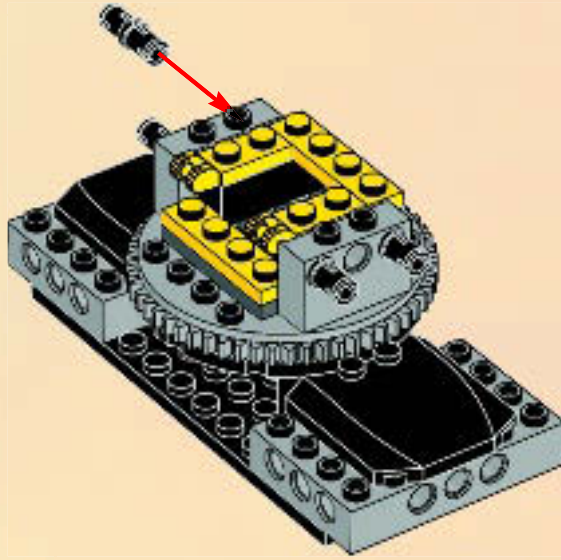

2x

7

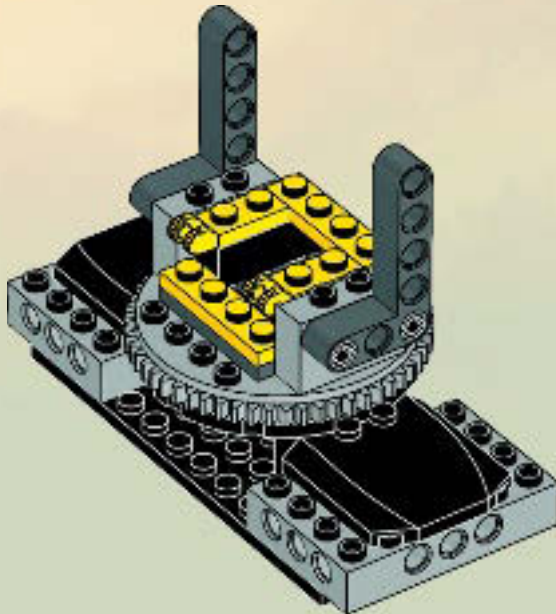

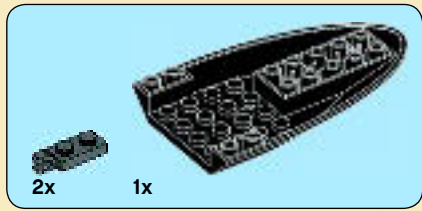

1

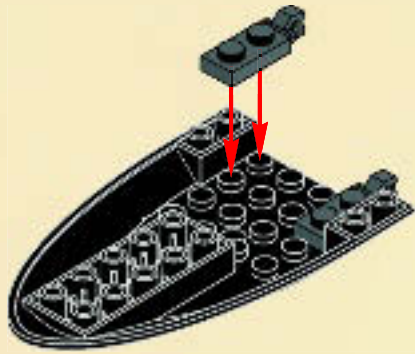

2

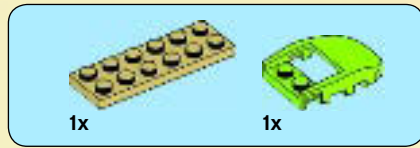
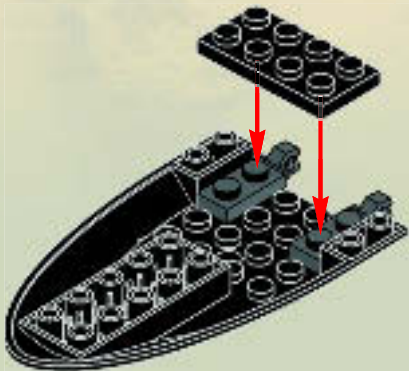

3



4

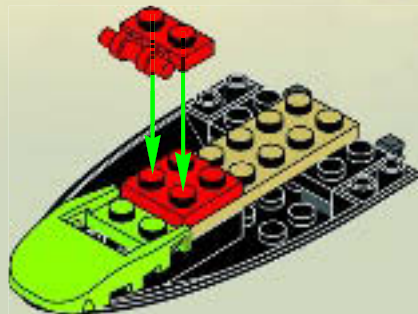





5

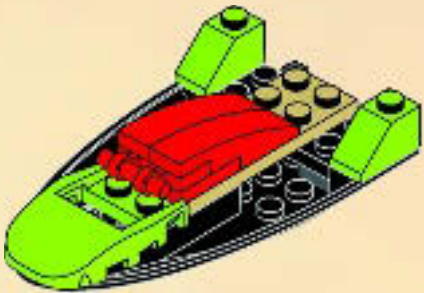

6

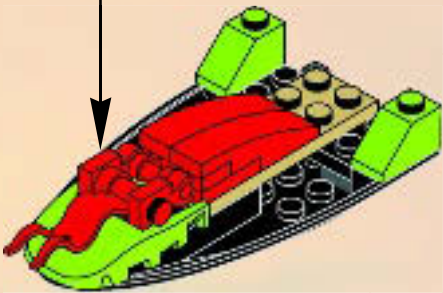
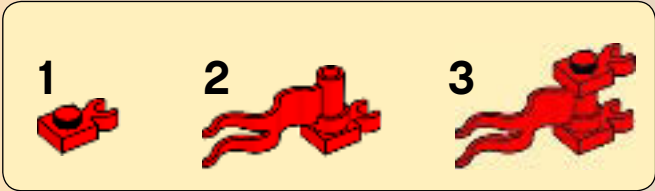

8

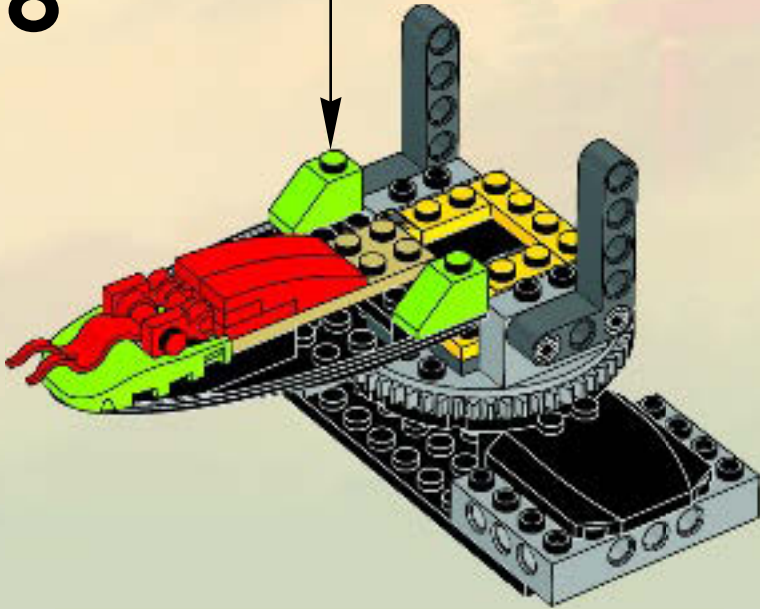

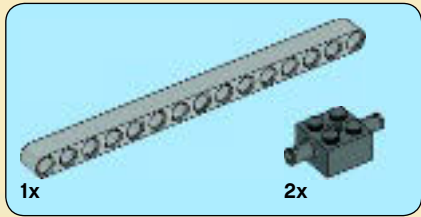
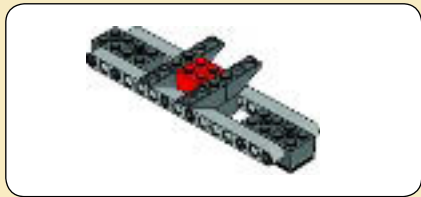

1

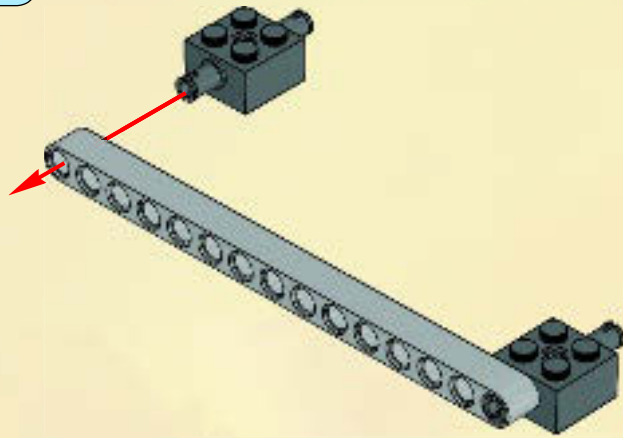

2

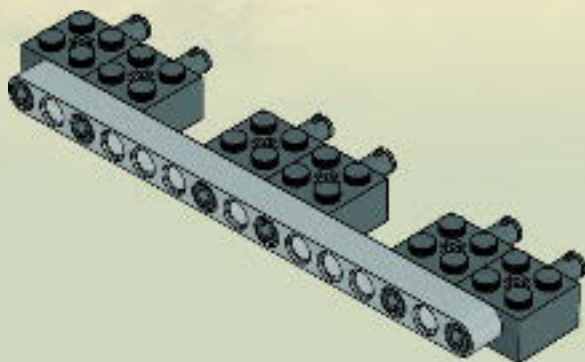



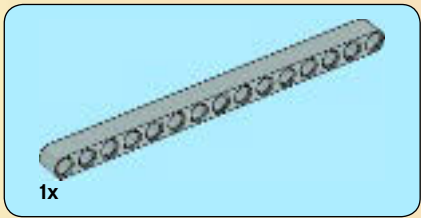

3

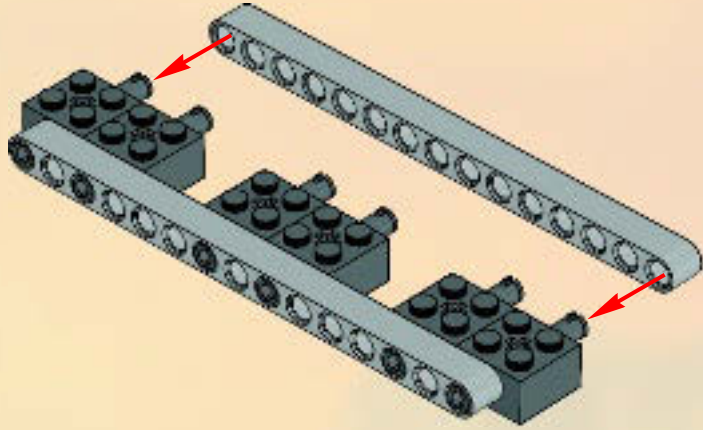

4

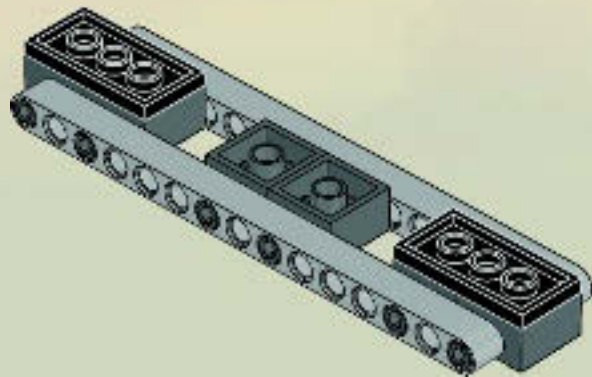

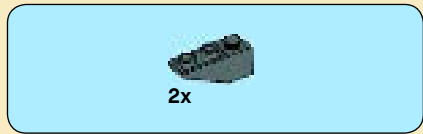

5

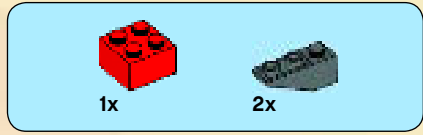
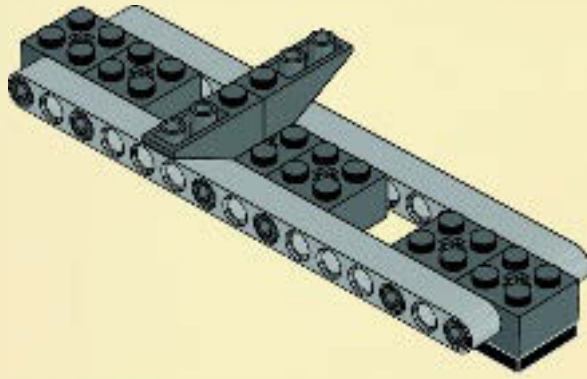
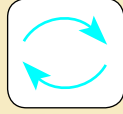

6

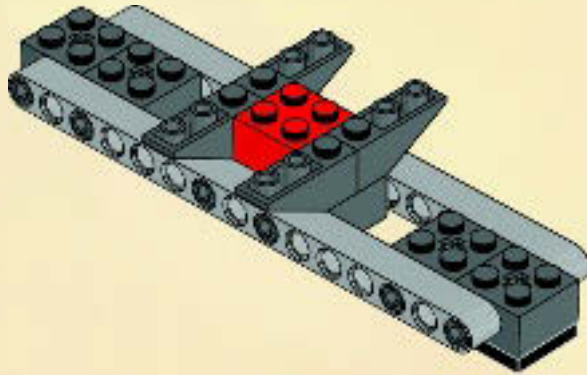

9

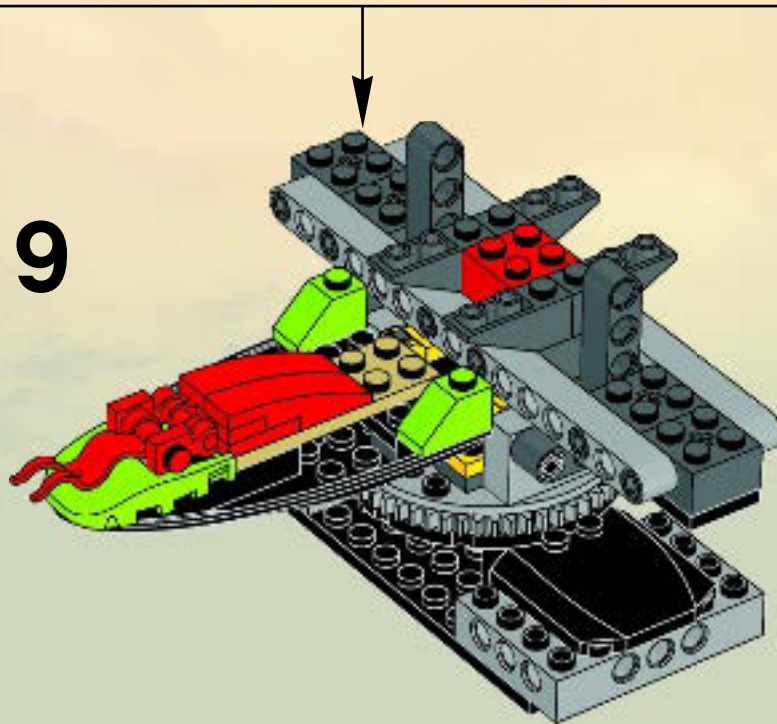



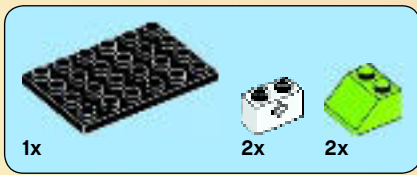

# 10

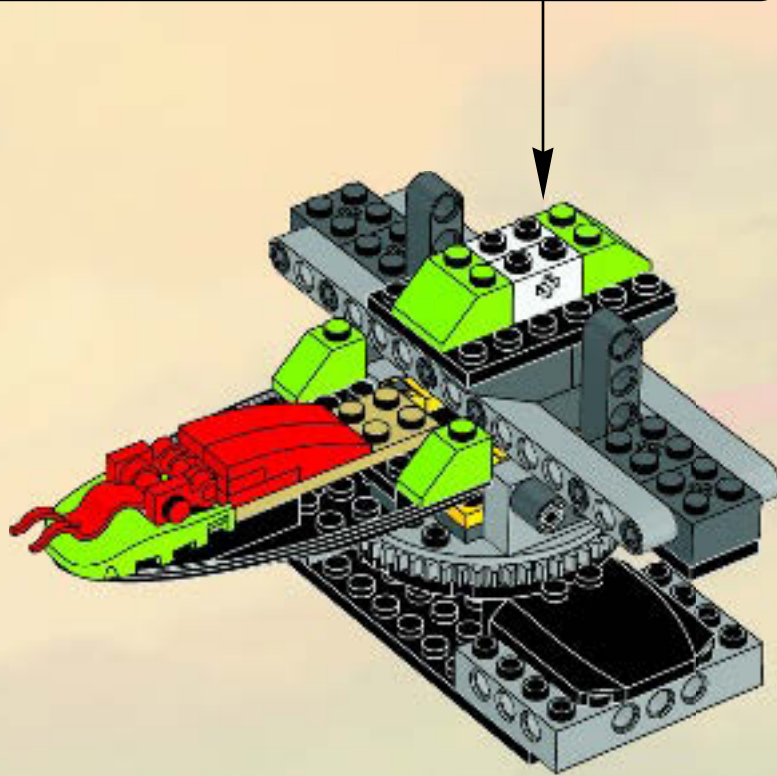
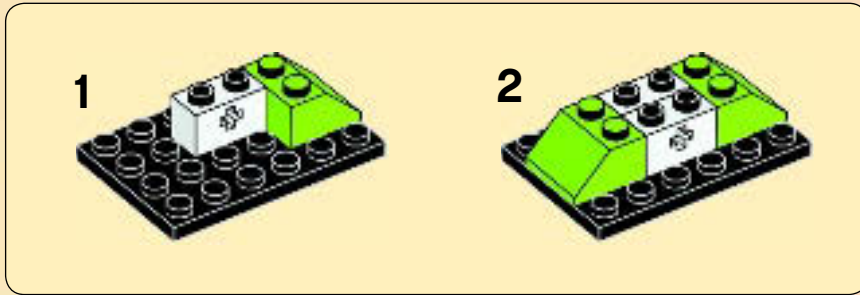

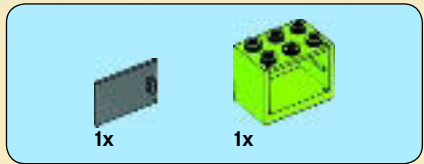
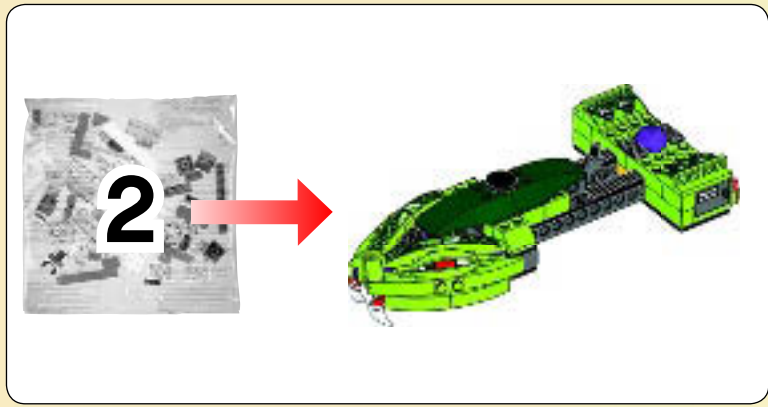

**1**

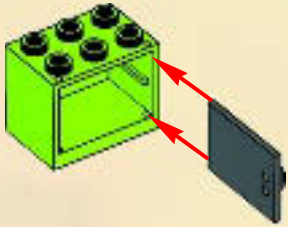

**2**

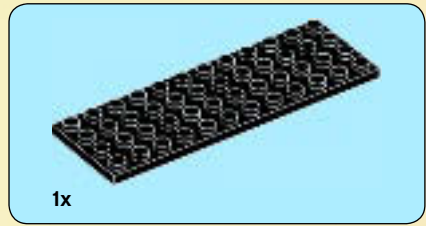
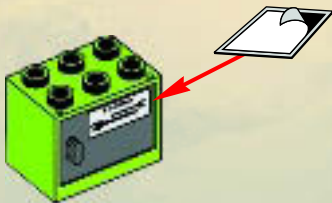

**3**

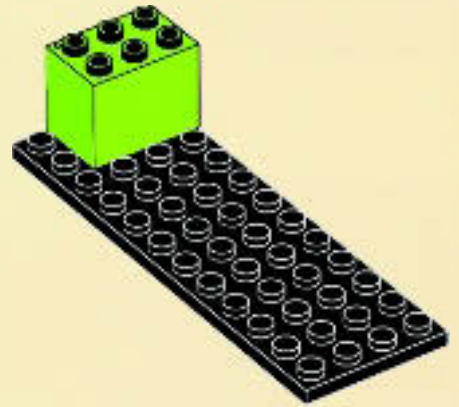

**4**

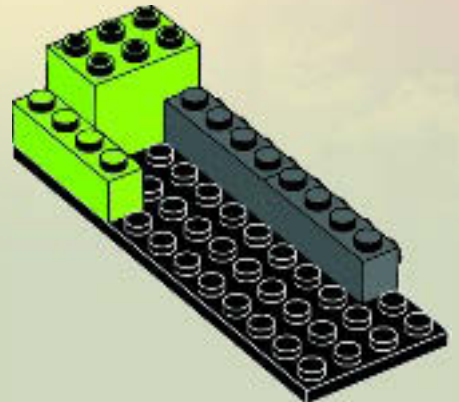

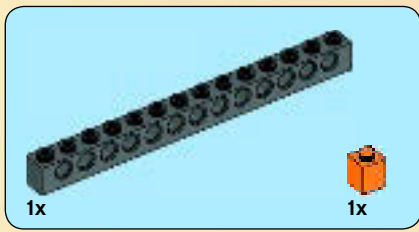

5

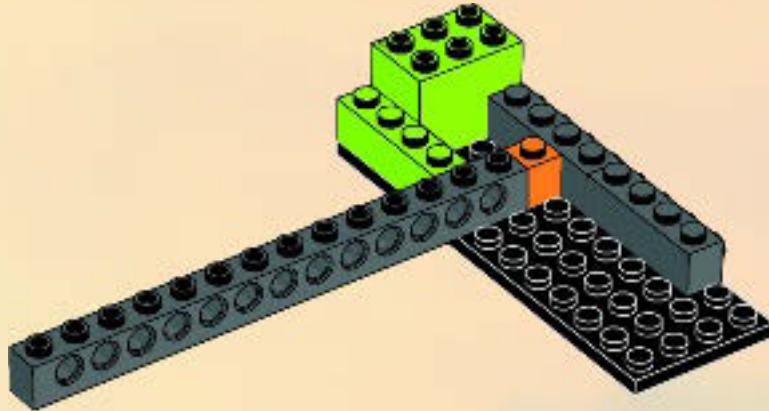

6

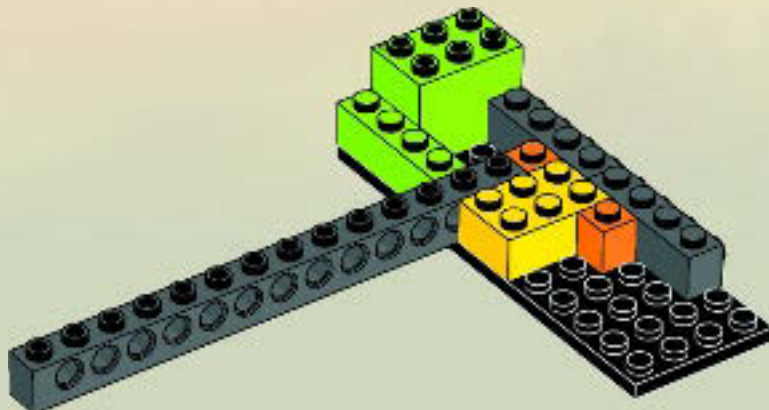



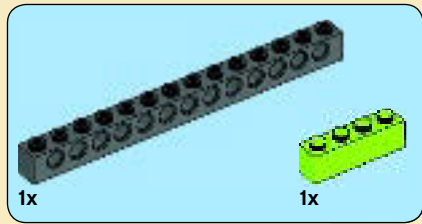

7

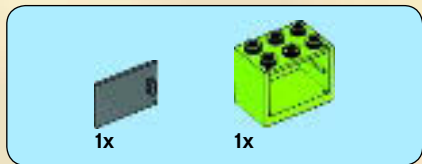
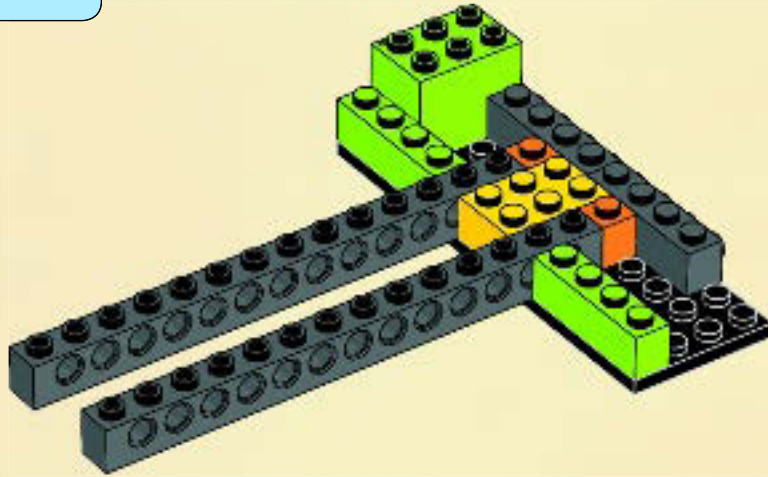

8

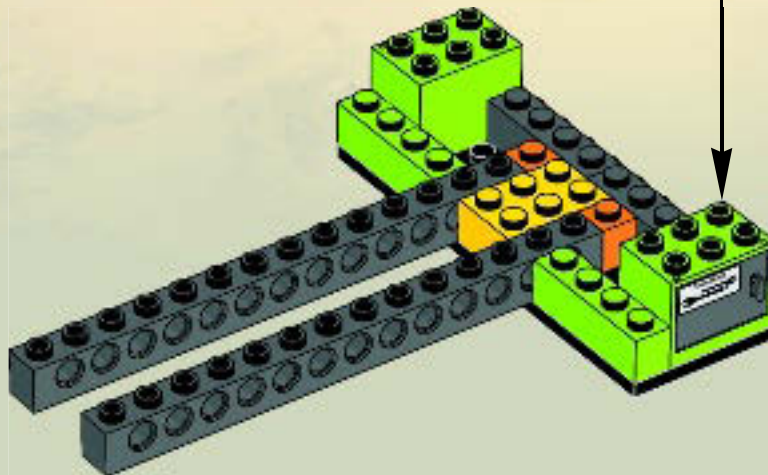
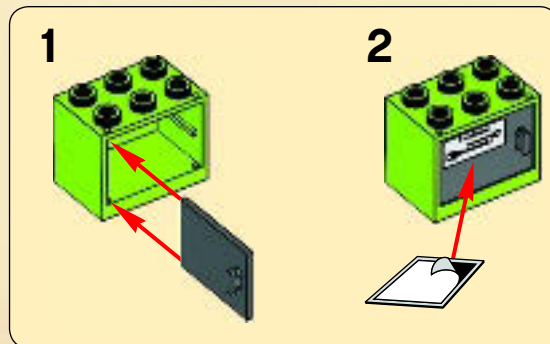

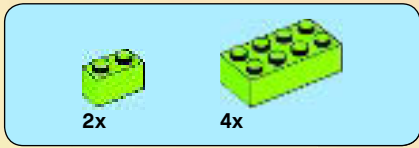

9

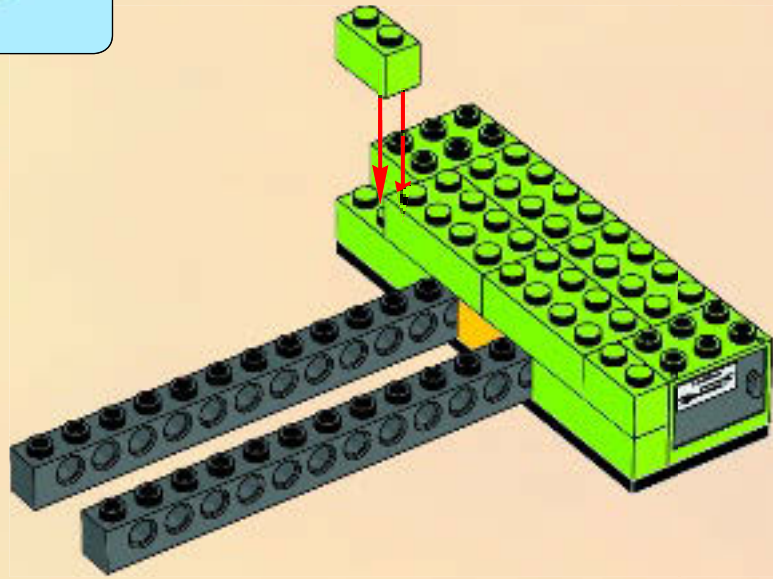

10

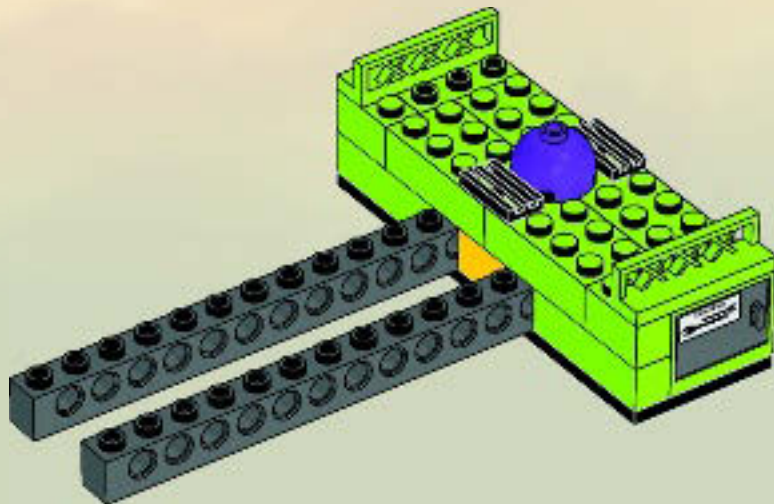

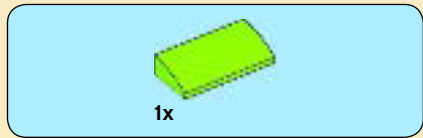

11

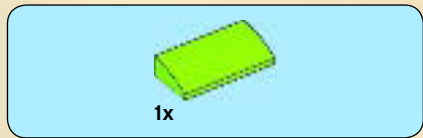
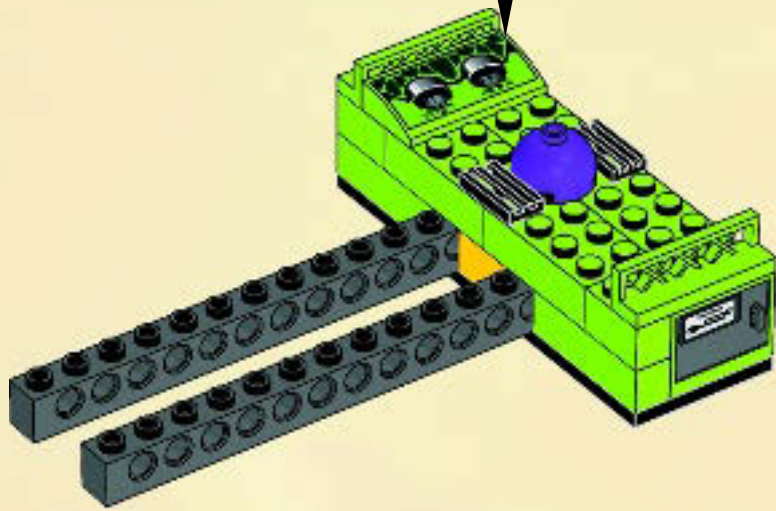
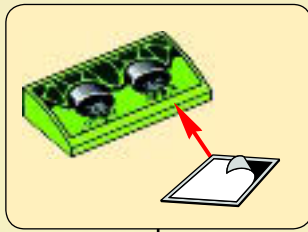

12

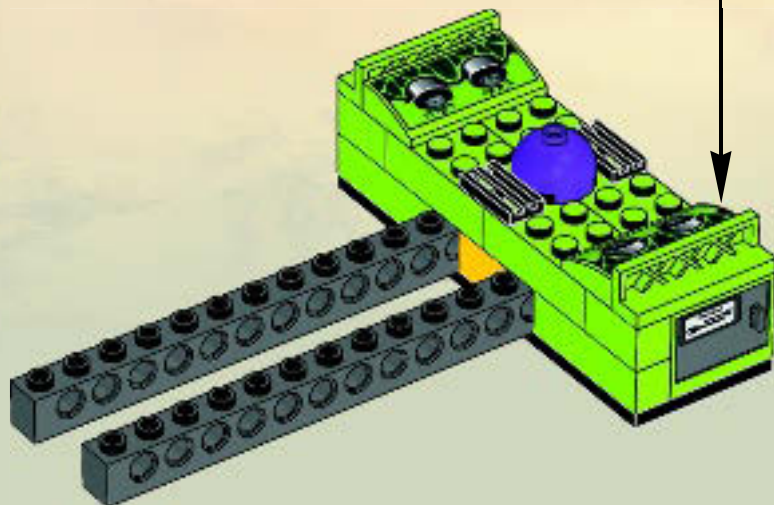



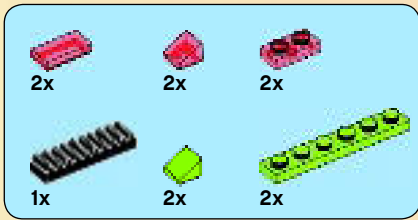

# 13

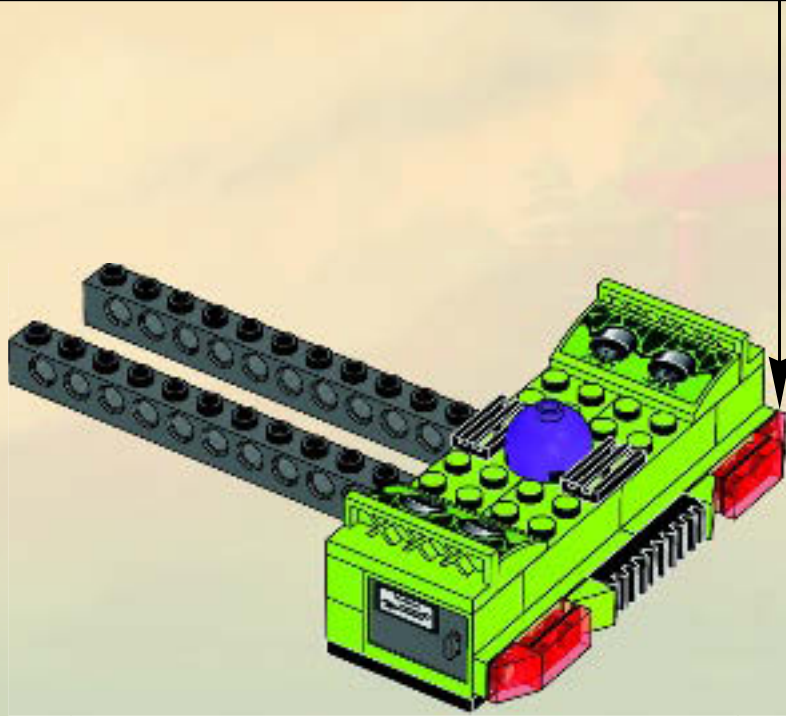
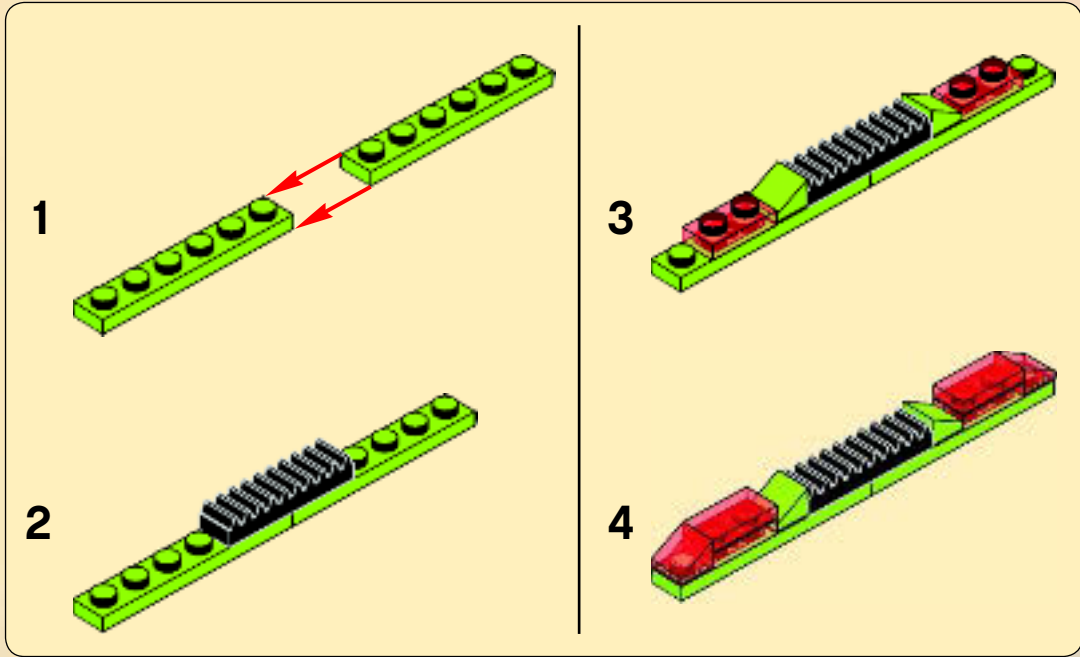



1

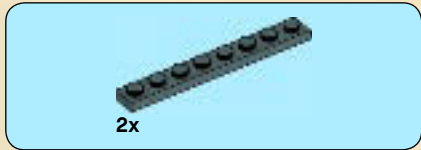
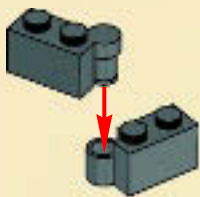

2



3

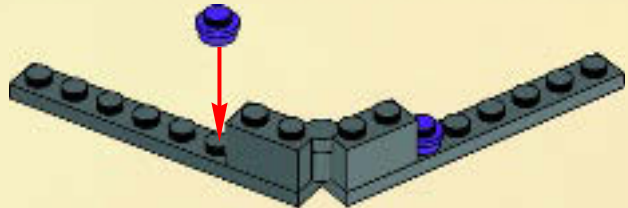

4

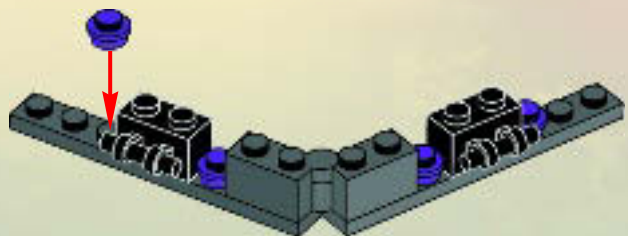



5

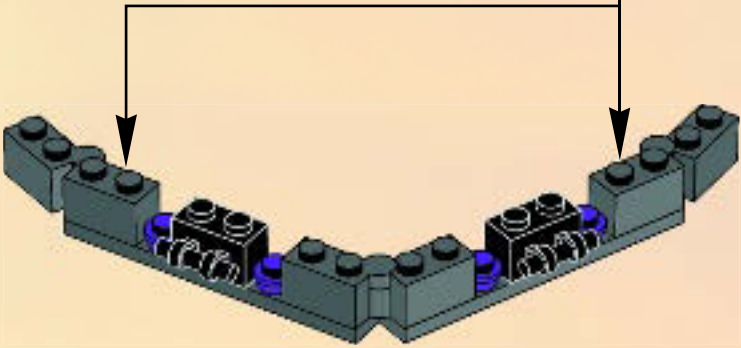
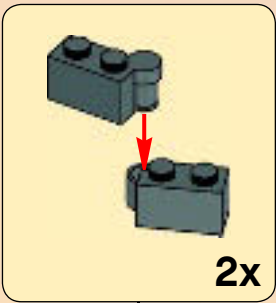

6





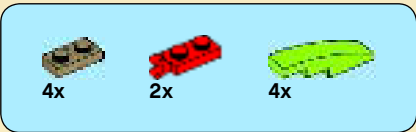

# 7

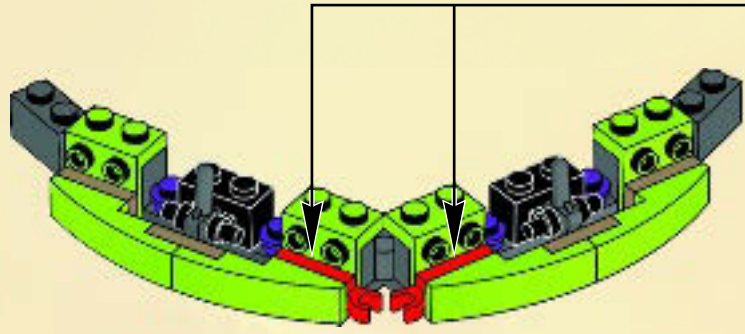
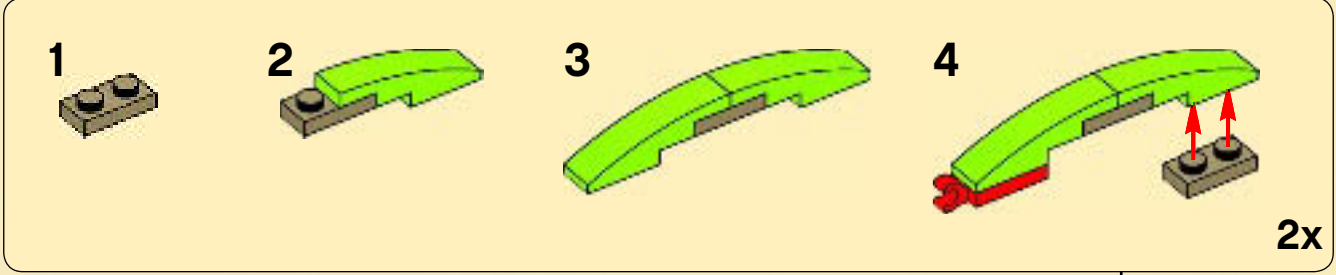

# 8





9

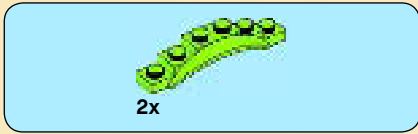

10





2x

# 11



1x

# 12

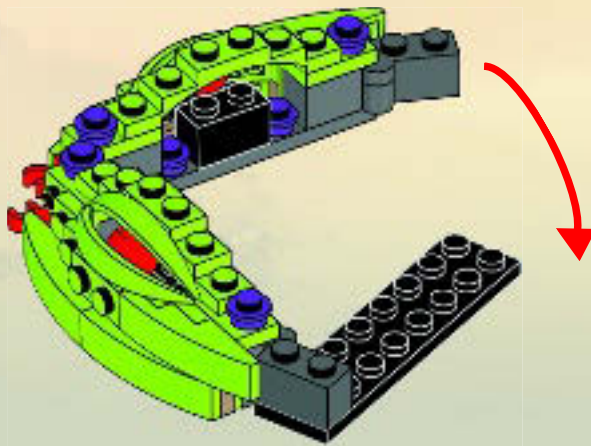



# 13

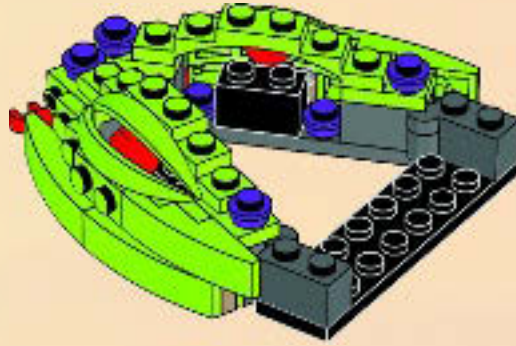

# 14

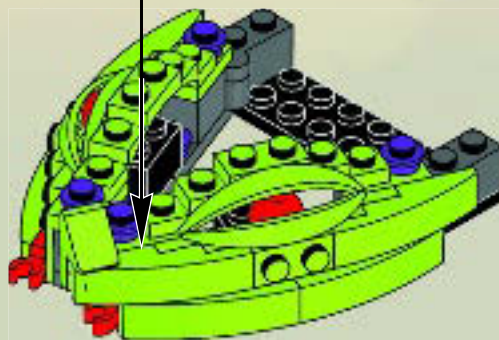



# 15

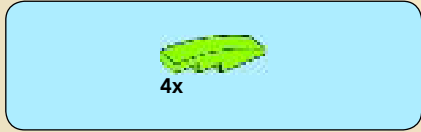
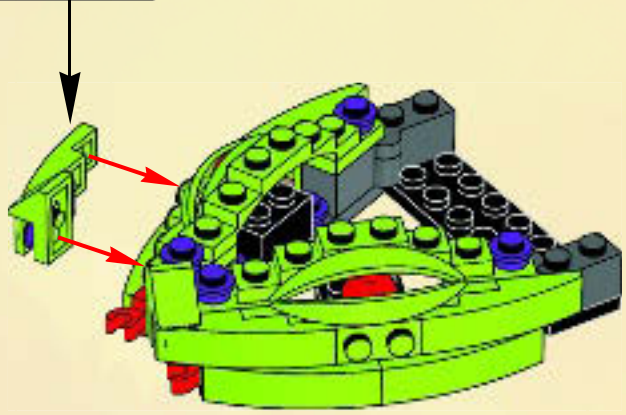

# 16

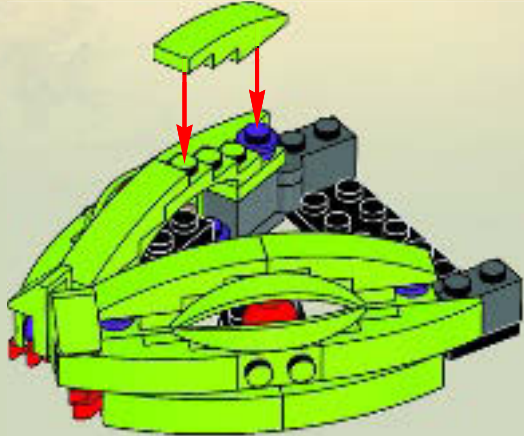

17

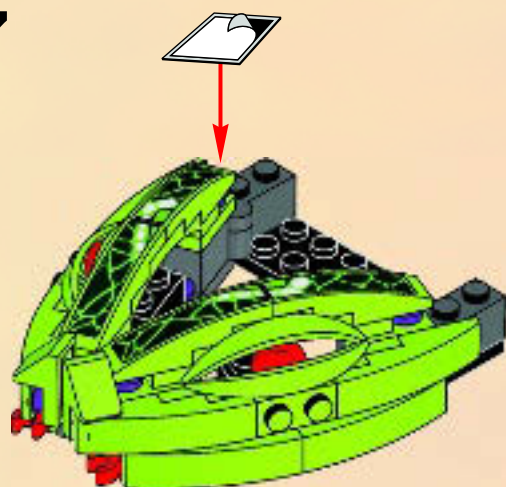

18

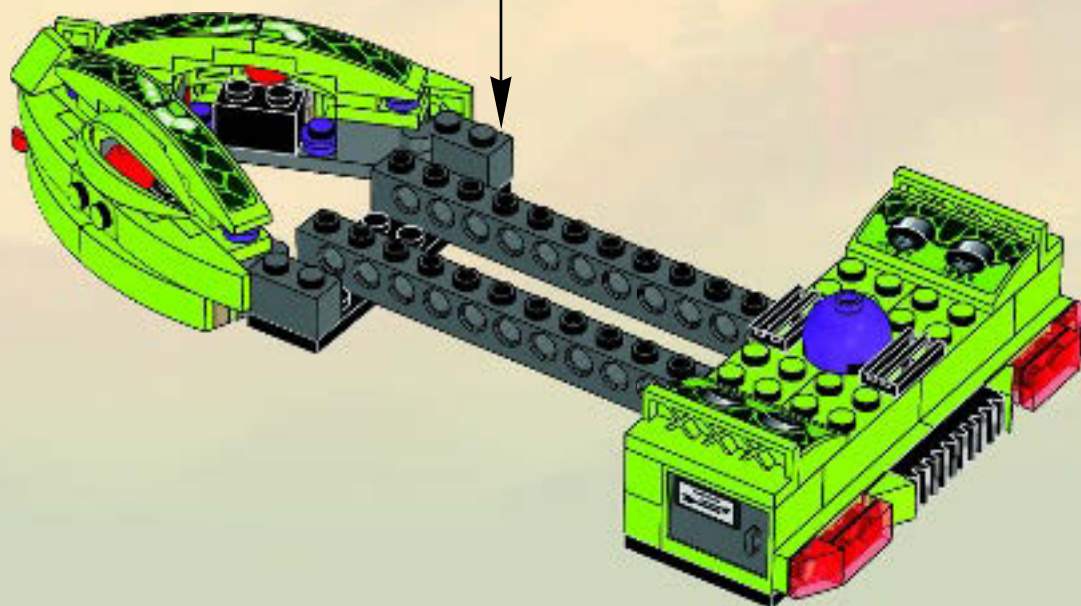

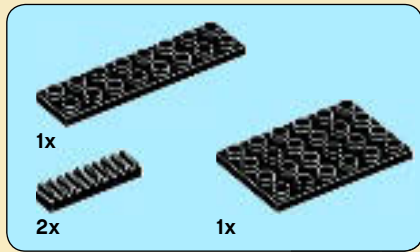

19

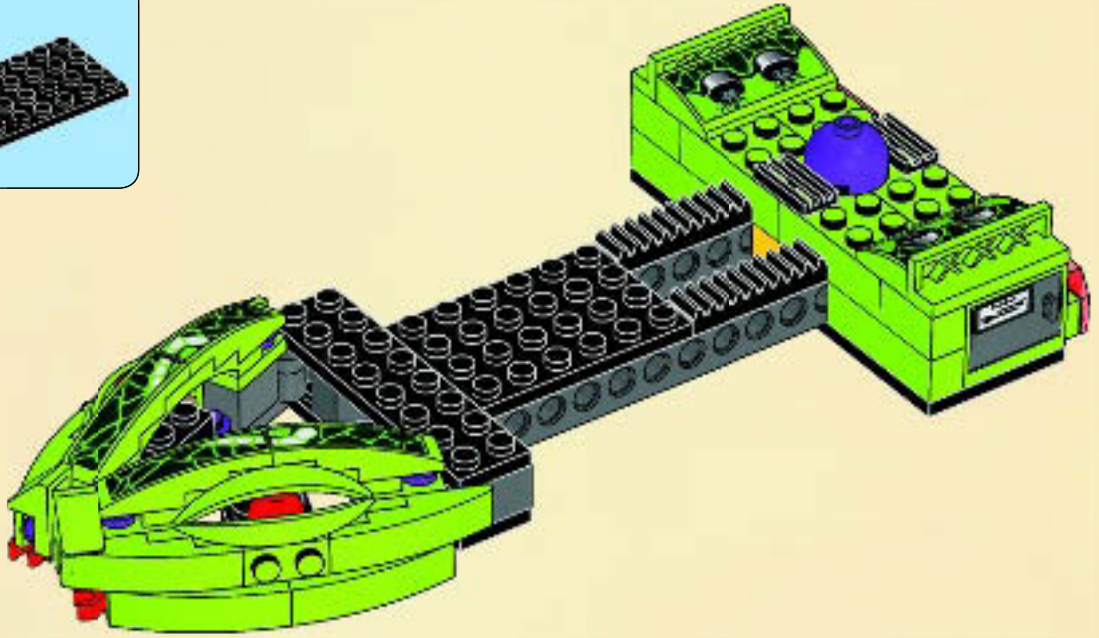

20

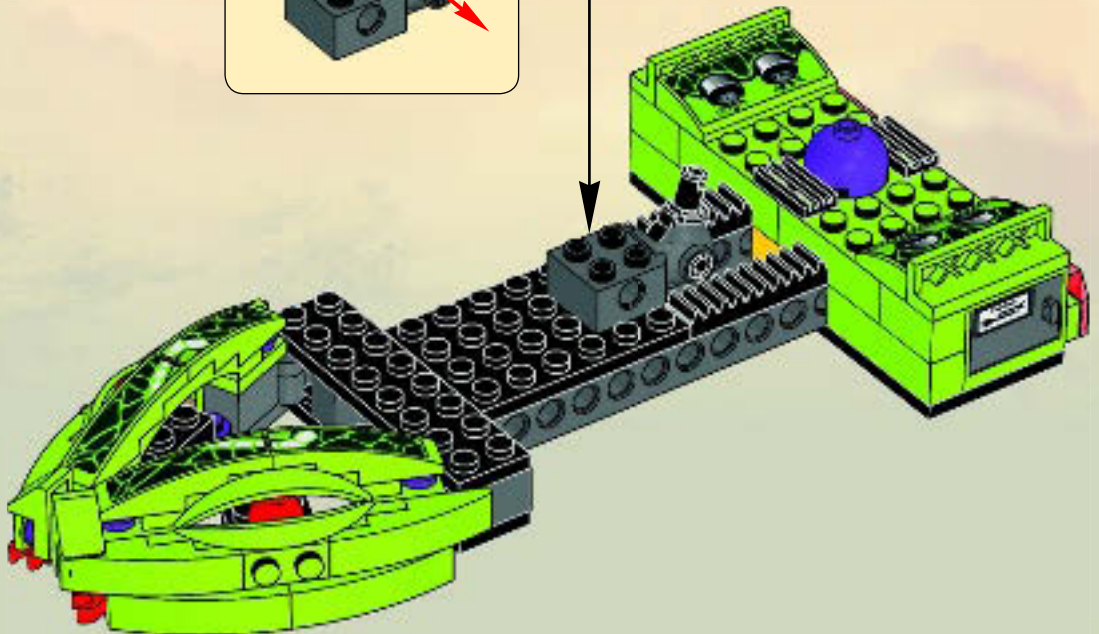
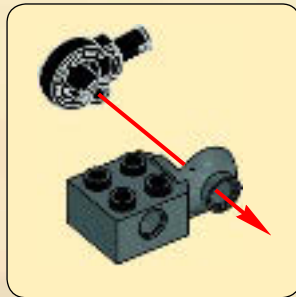



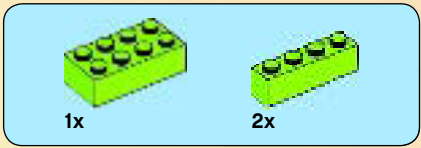

21

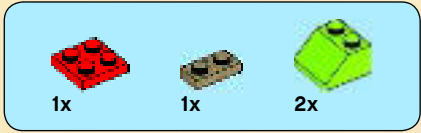
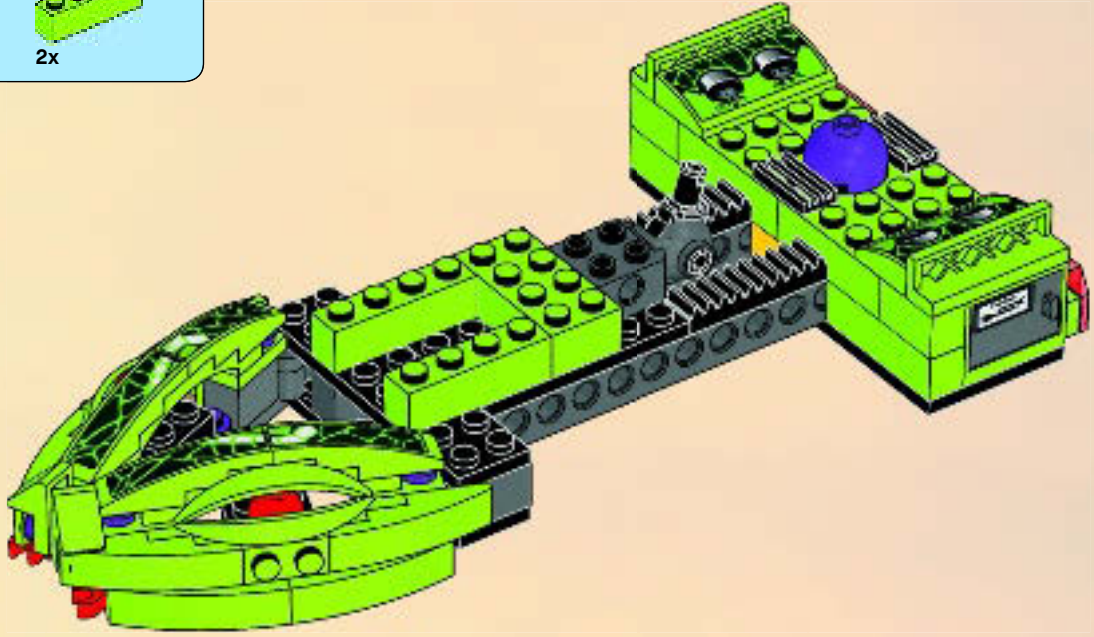

22

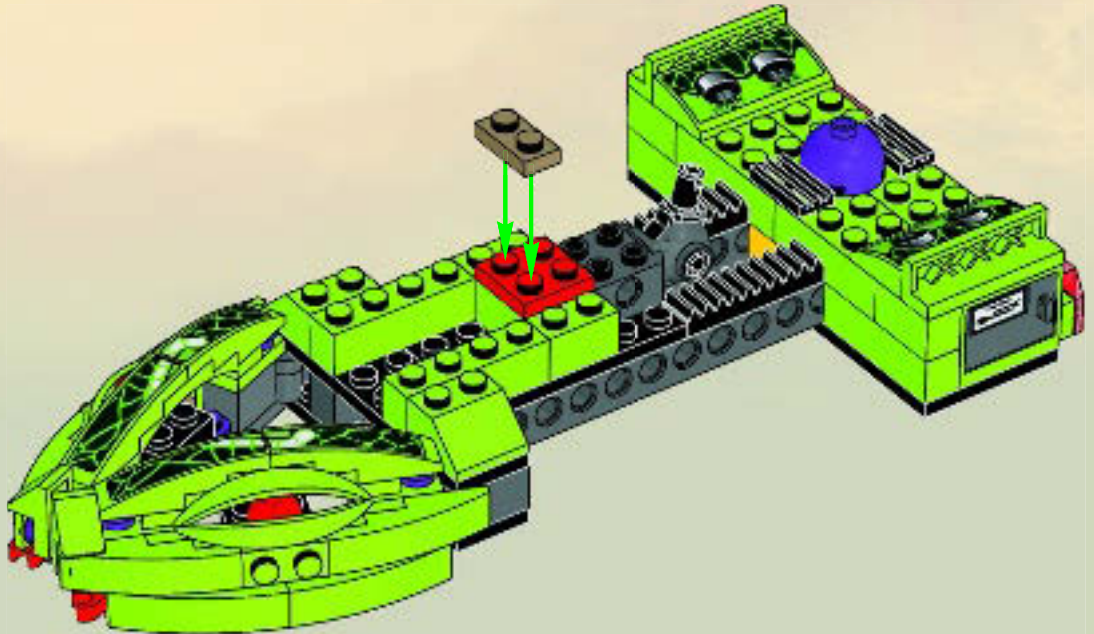



23

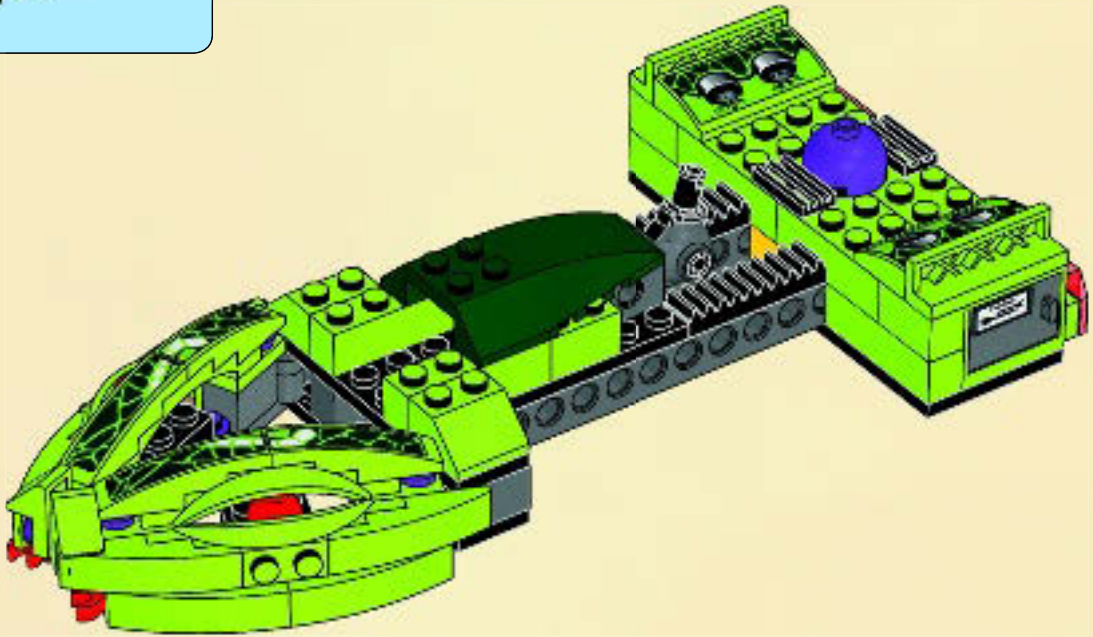

24

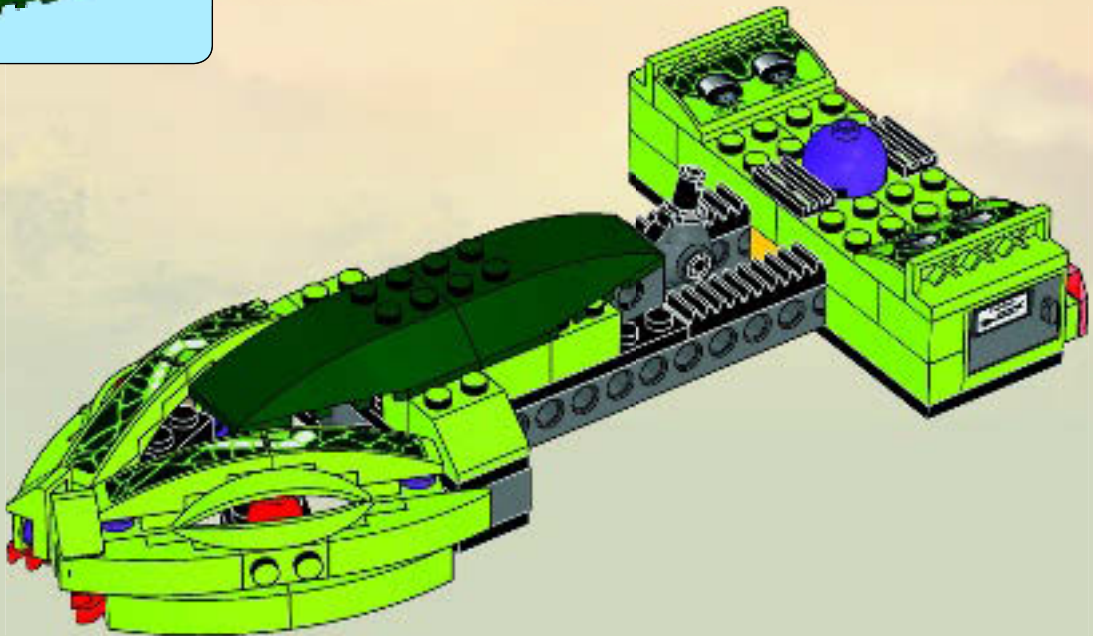





1x



2x

# 25

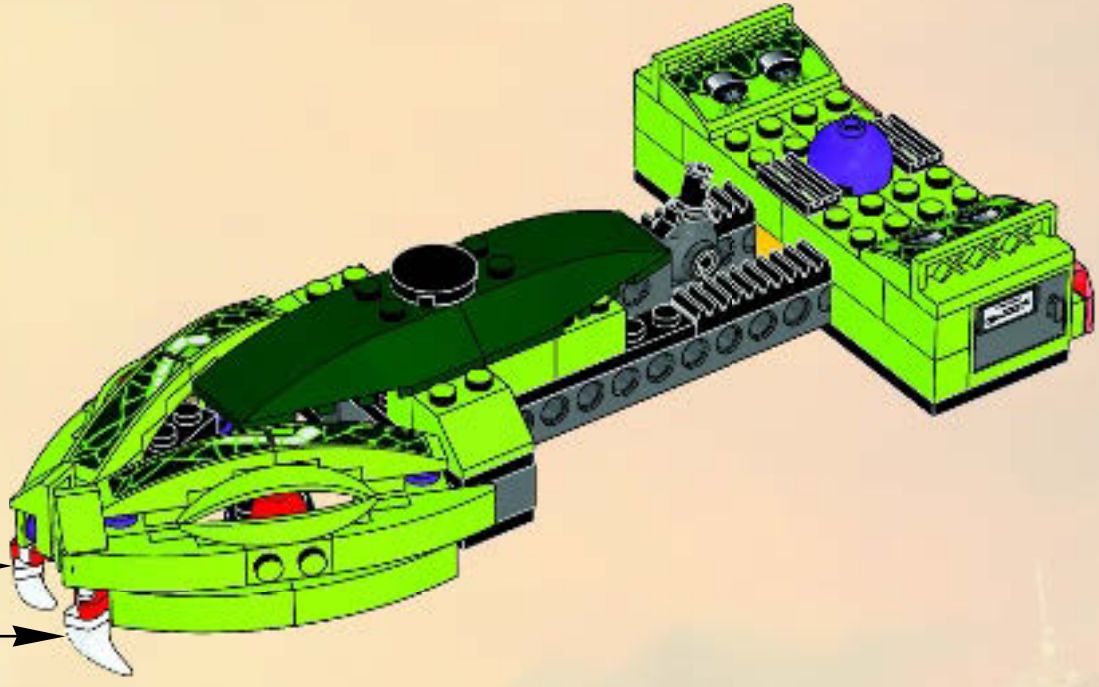

# 26

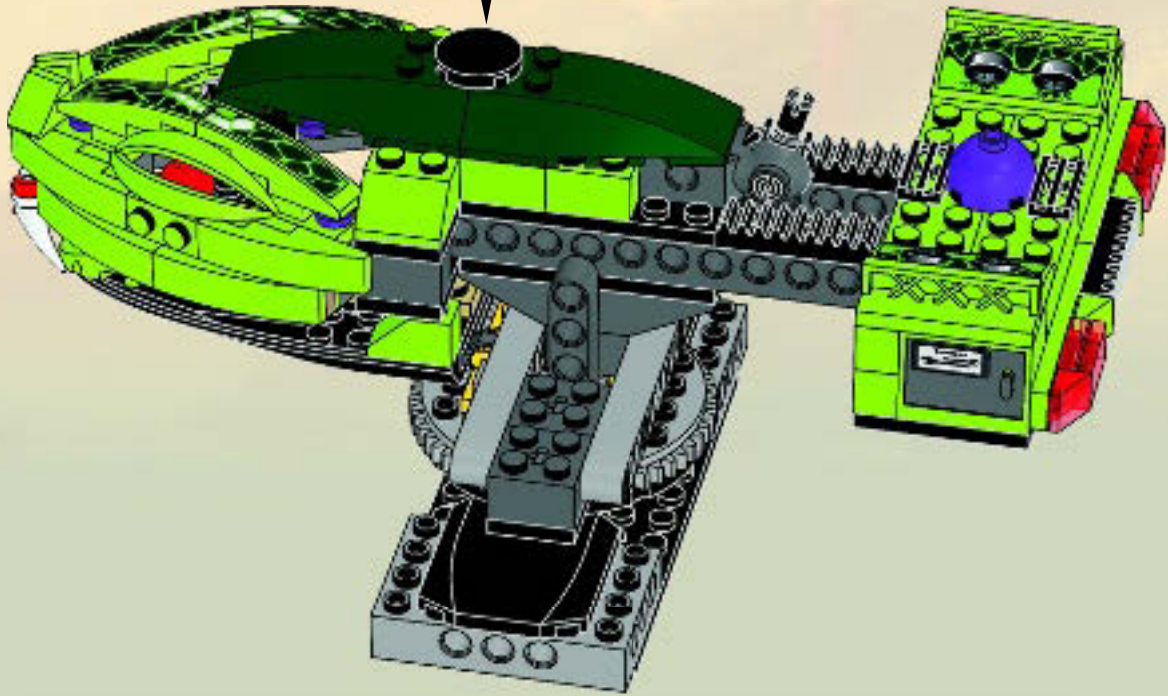

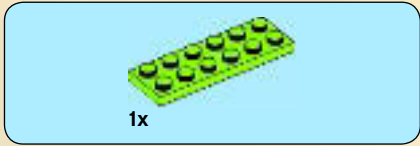
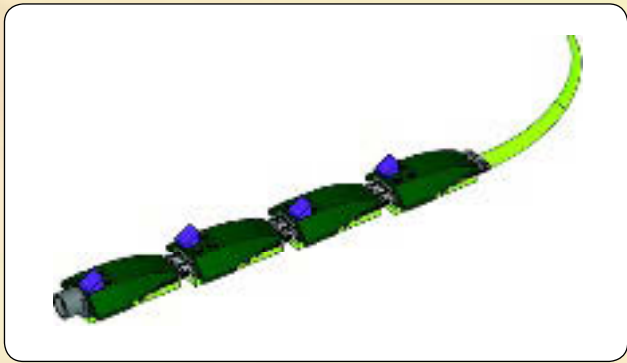
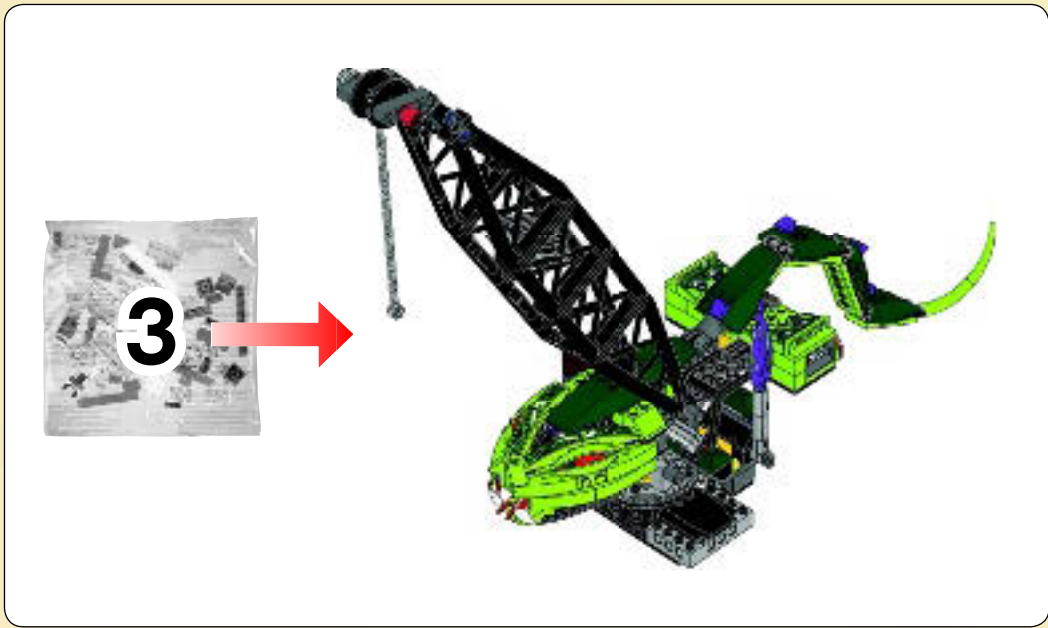

1





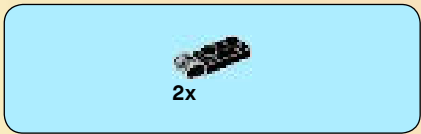

2

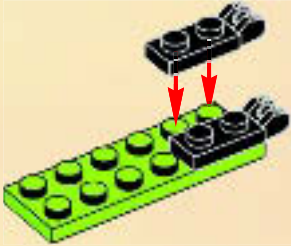

4



3

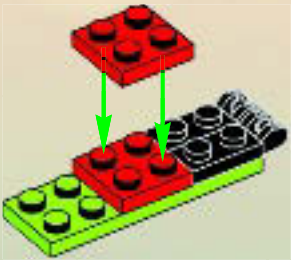

5



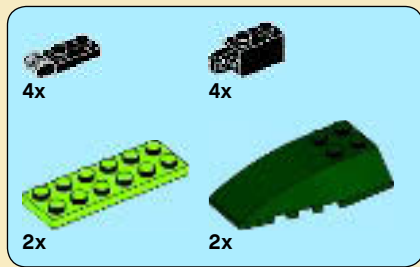

# 6

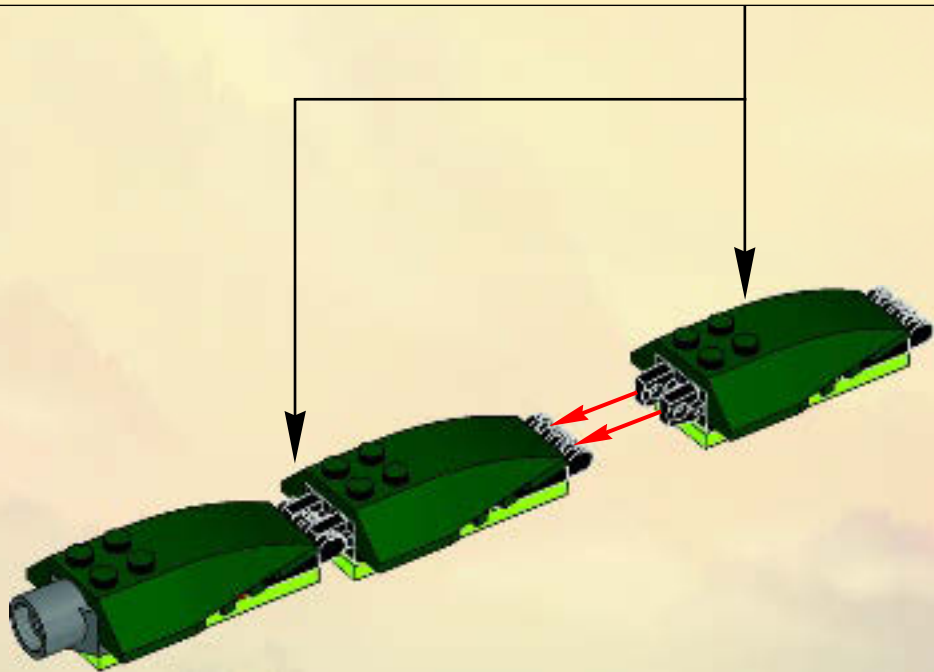
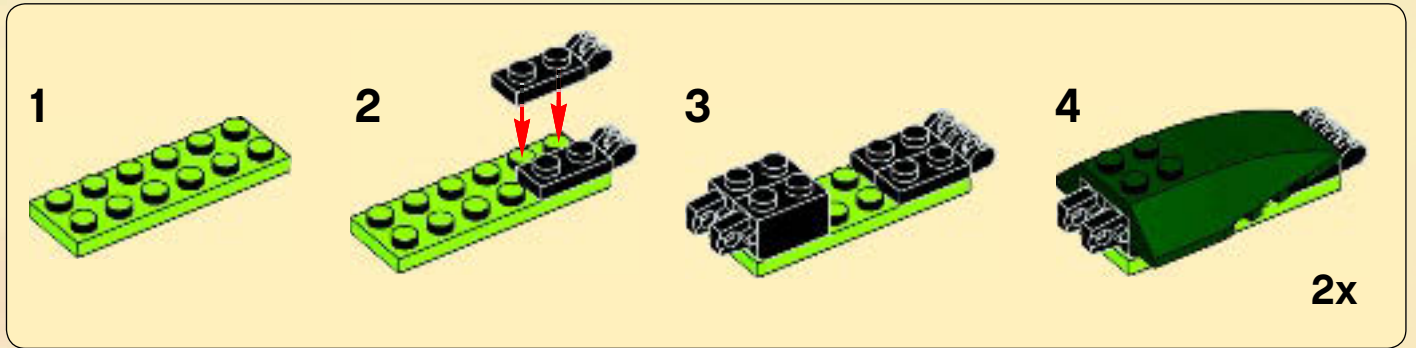

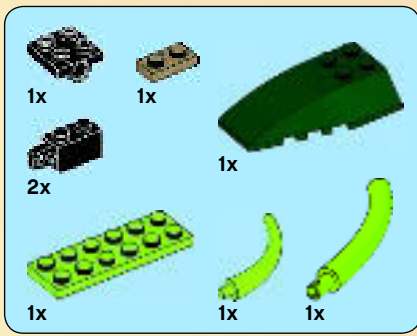

7

1

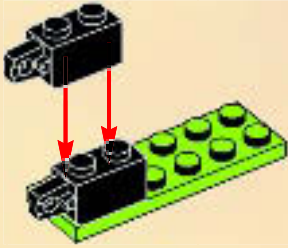

2



3



4

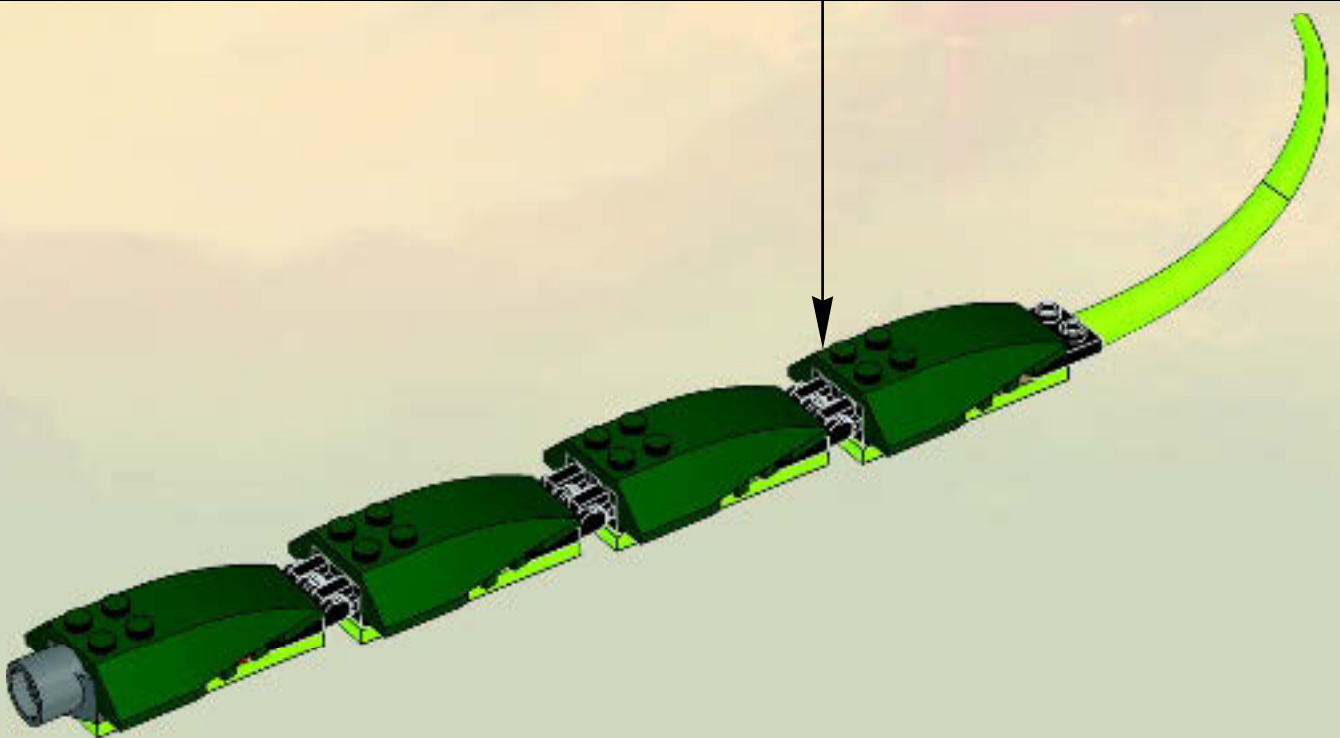
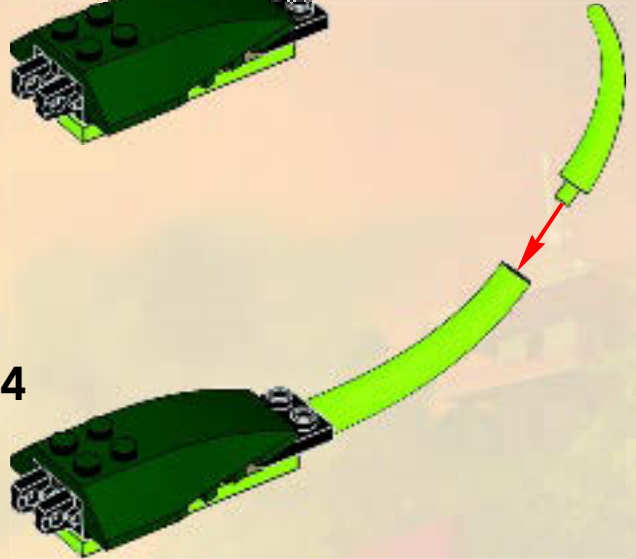



4x

8

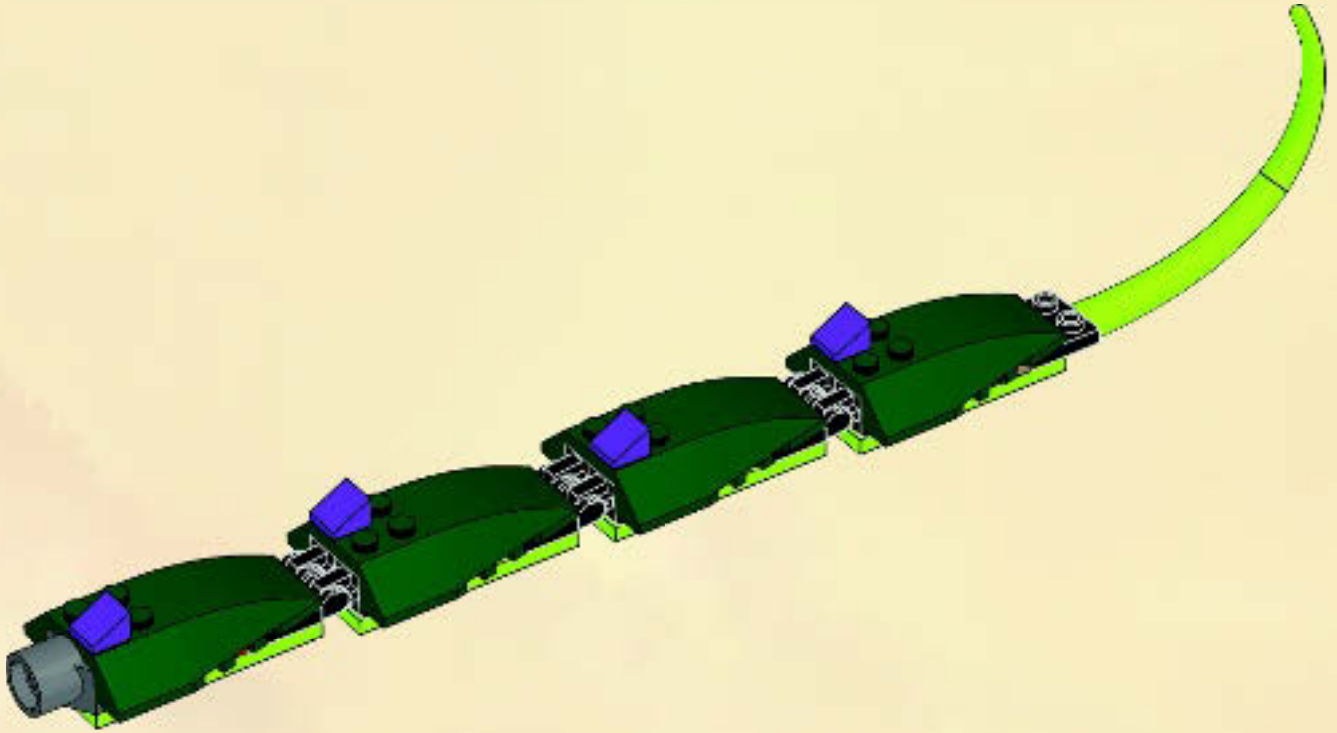



27

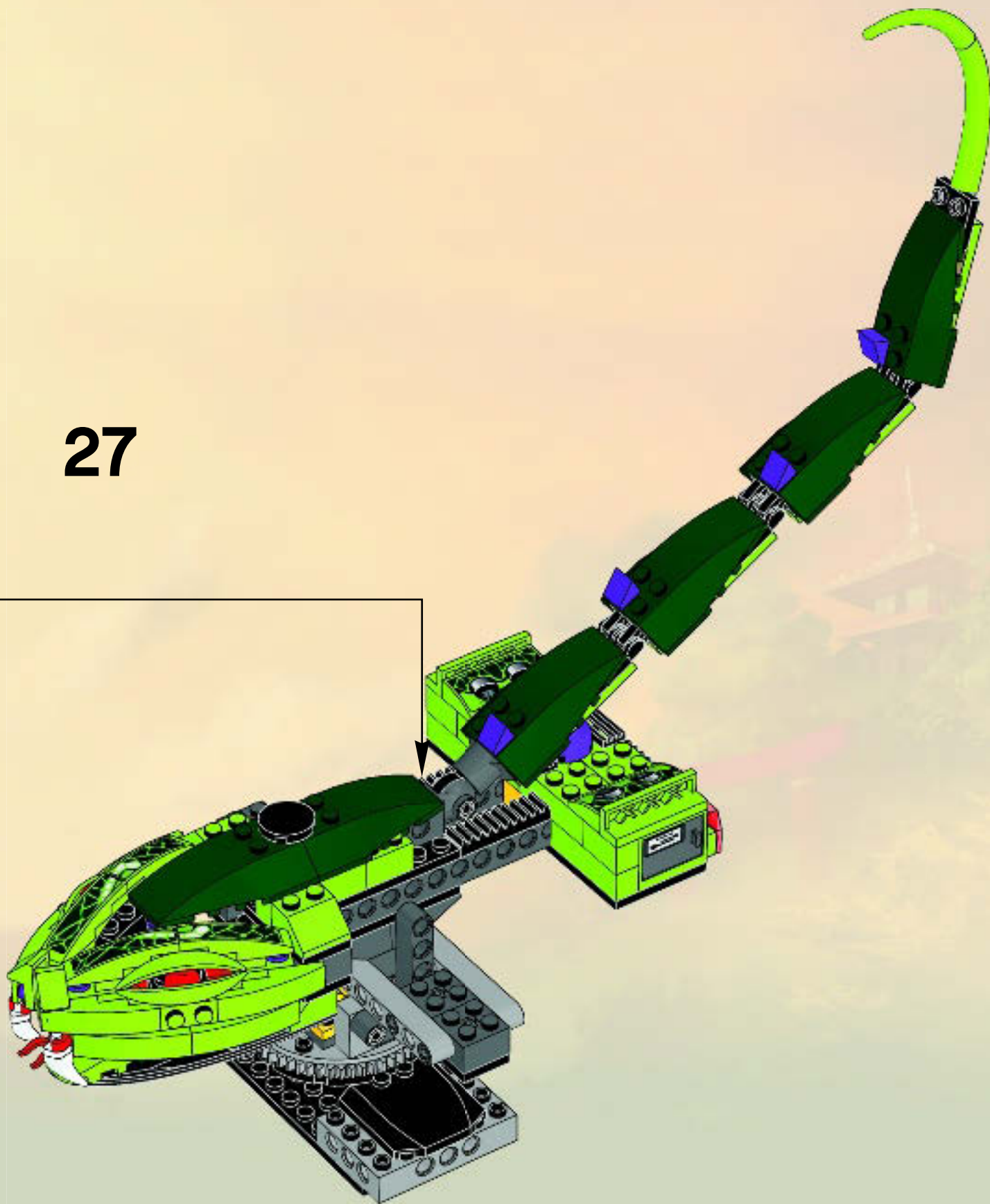

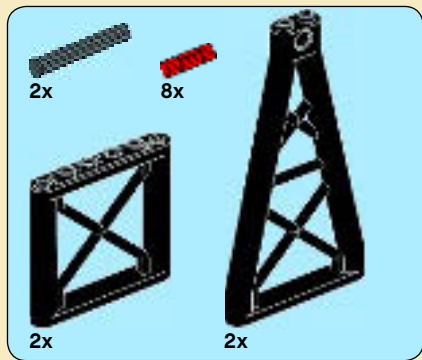

# 28

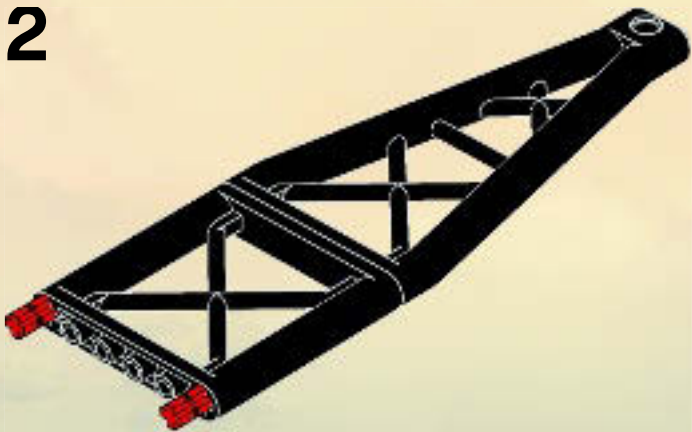
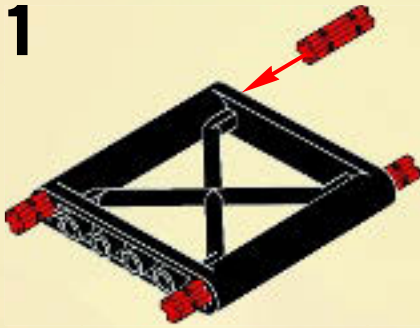

2x







1x

29

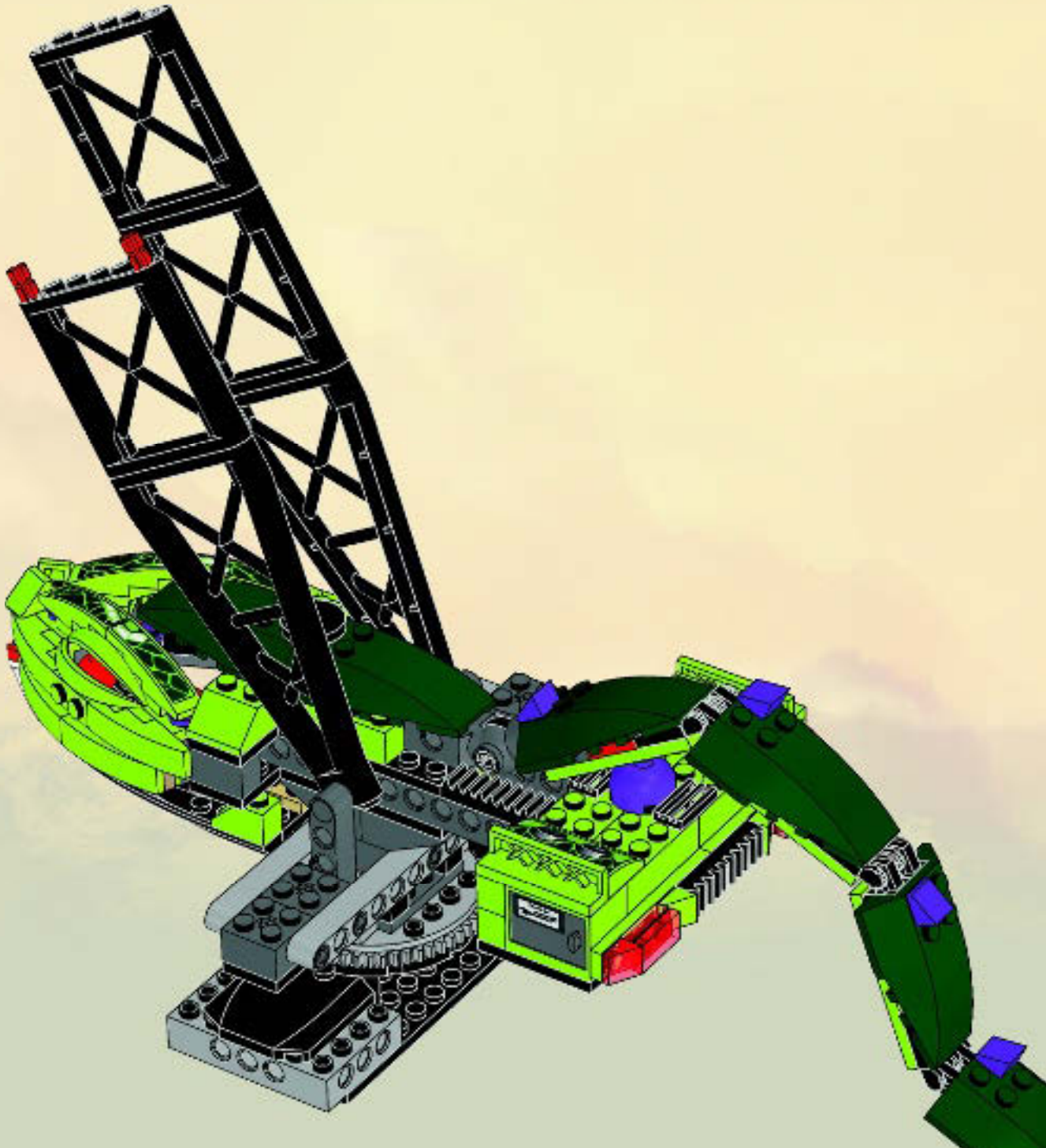





# NINJAGO

Masters of Spinjitzu



NINJAGO.COM





# NINJAGO

Masters of Spinjitzu



- ☐  
9445
- ☐  
9442
- ☐  
9443
- ☐  
9446
- ☐  
9567  
9552
- ☐  
9564
- ☐  
9553
- ☐  
9561
- ☐  
9552
- ☐  
9566
- ☐  
9566
- ☐  
9441  
9558  
9579



- ☐  
9444
- ☐  
9441  
9558
- ☐  
9441  
9444  
9446
- ☐  
9579
- ☐  
9562  
9440
- ☐  
9444  
9558  
9566
- ☐  
9551
- ☐  
9440  
9445  
9446  
9553  
9558
- ☐  
9562
- ☐  
9558
- ☐  
9558  
9563  
9567
- ☐  
9564





9551



9443



9446



9446



9443



9446



9552



9444  
9579



9561  
9553



9442  
9558



9579  
9558



9562



9564



9443



9442  
9445



9446



9446  
9551  
9558  
9561



9579



9579



9567



9563



9440



9445  
9563





# NINJAGO

Masters of Spinjitzu







1

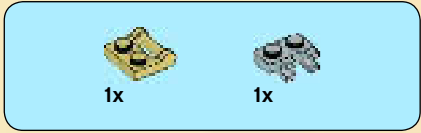

2

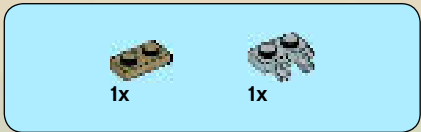

3

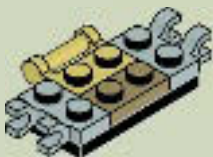

4

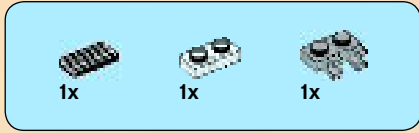
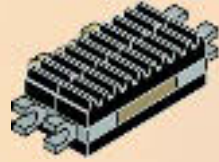

5

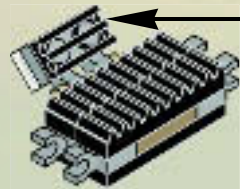
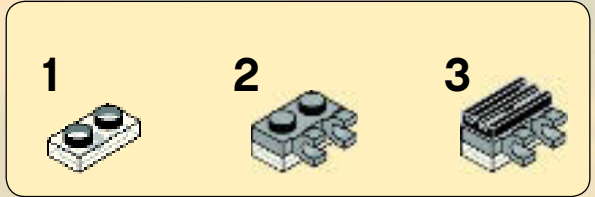

30



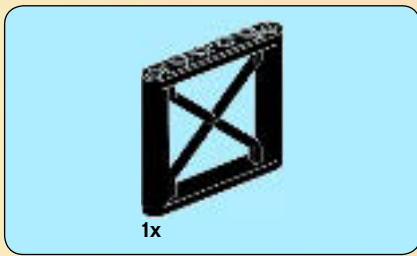

31



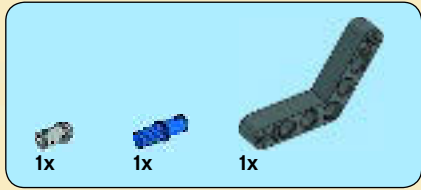

1

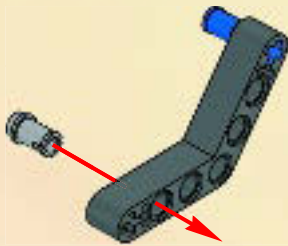

2

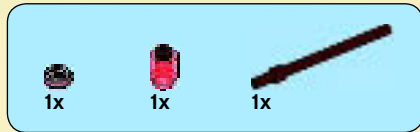
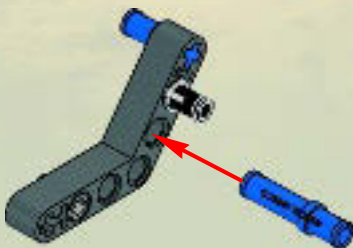

3

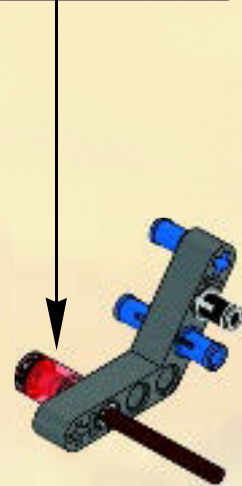
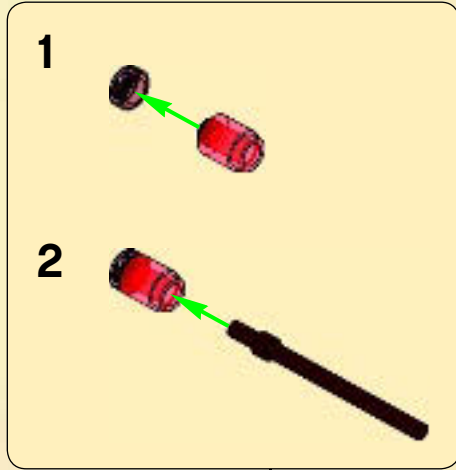





4

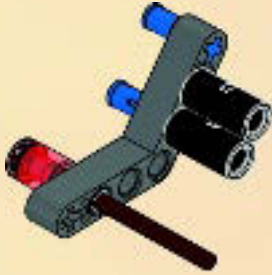

5

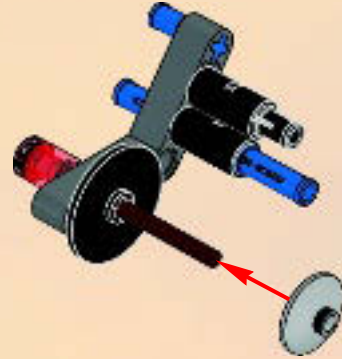

4

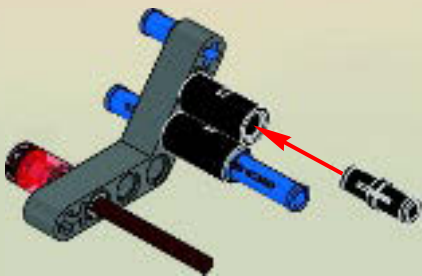

6

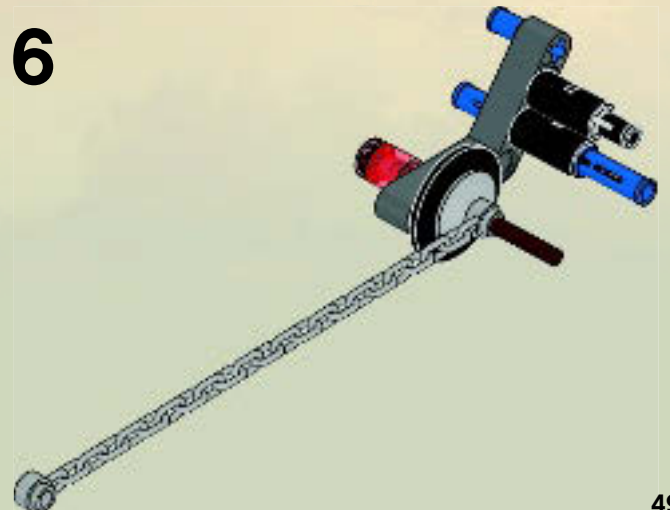



7

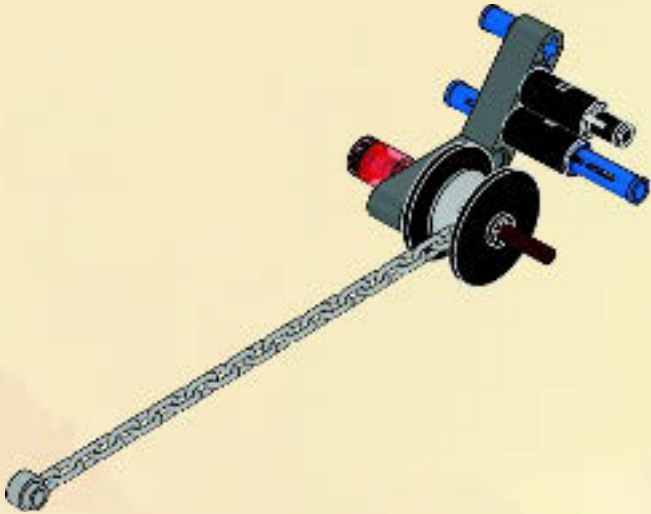

9

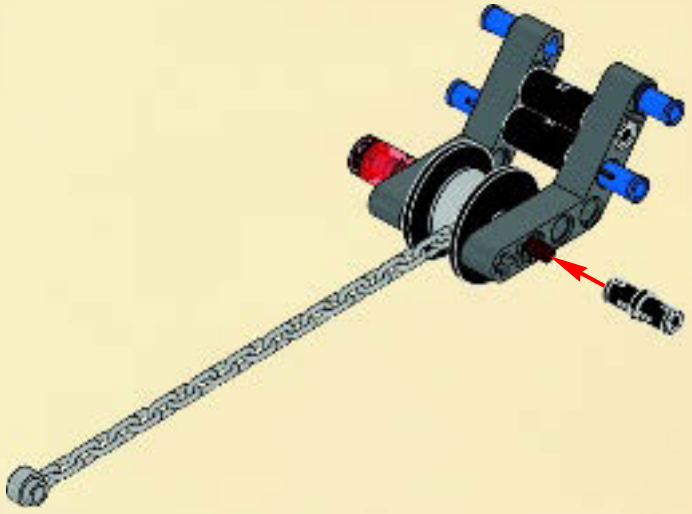

8

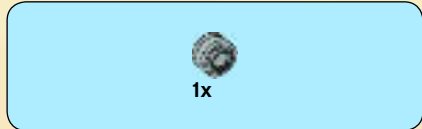
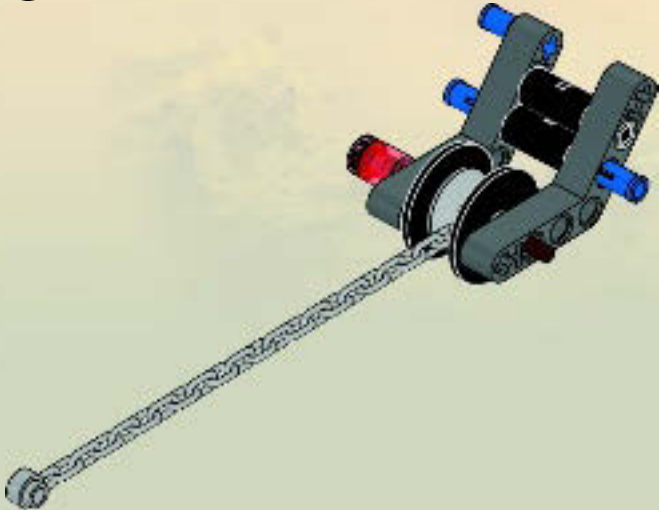

10

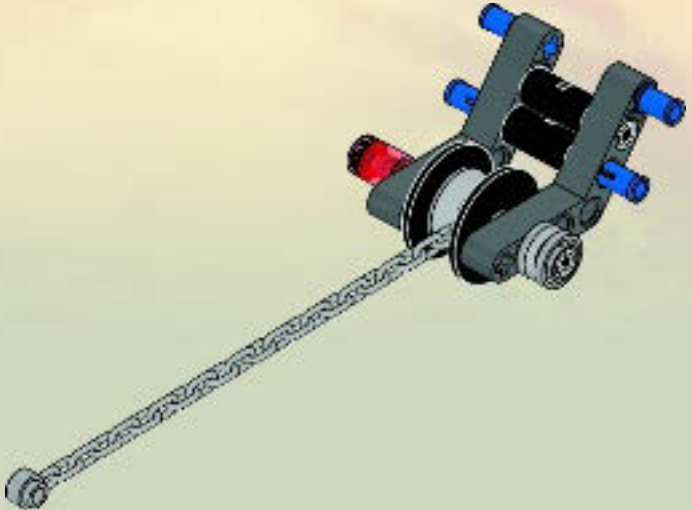

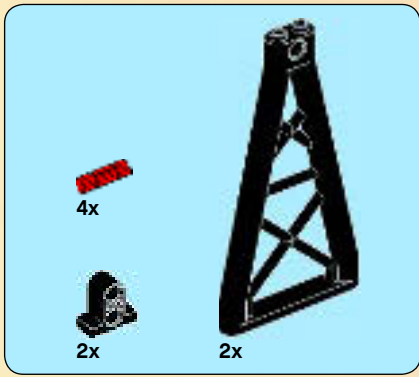

11

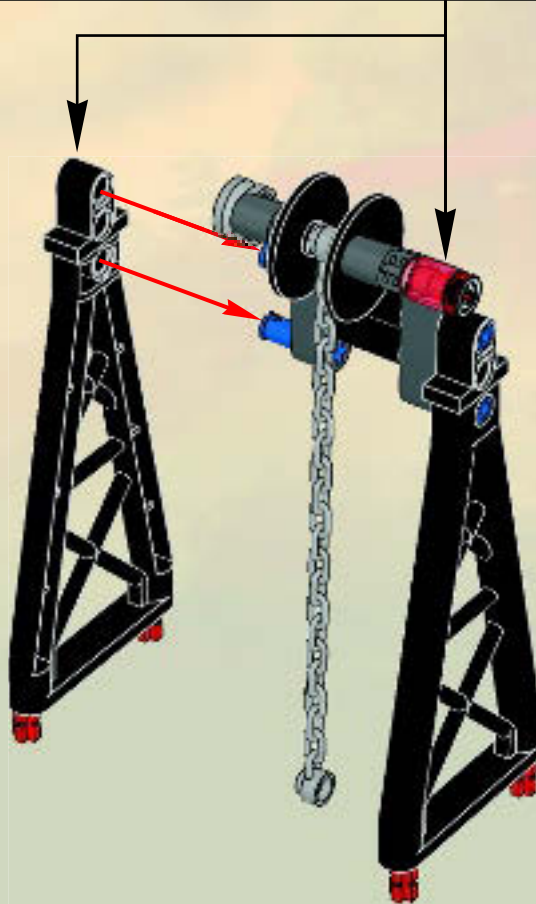
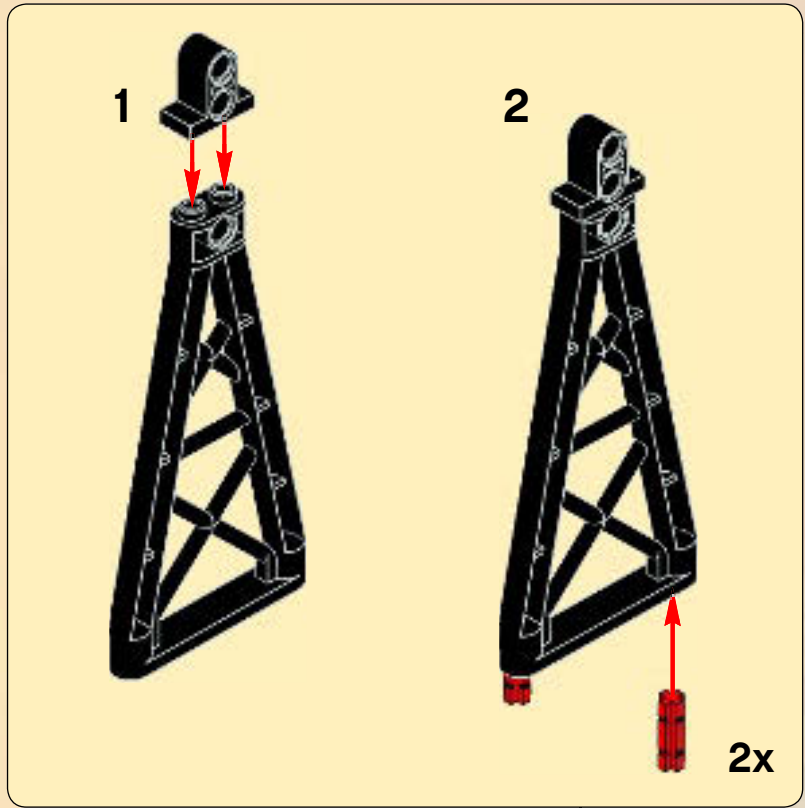





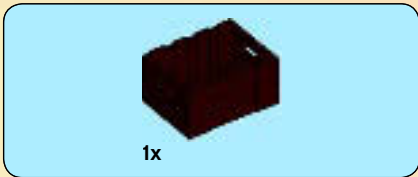

33





1



2

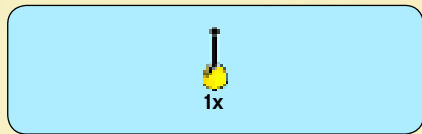

3

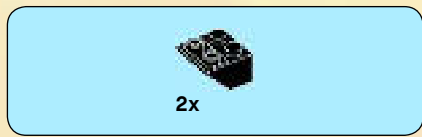

4



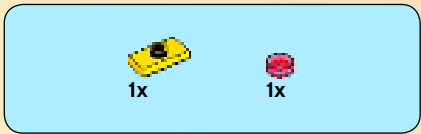

5

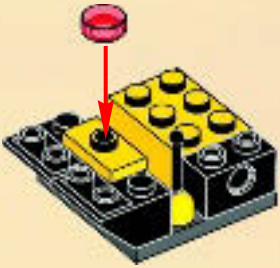

7



6

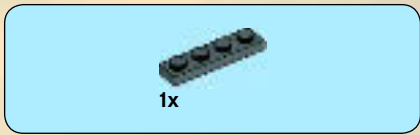

8

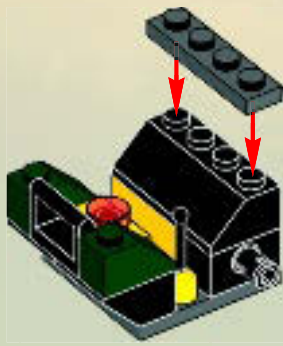



9



10



11

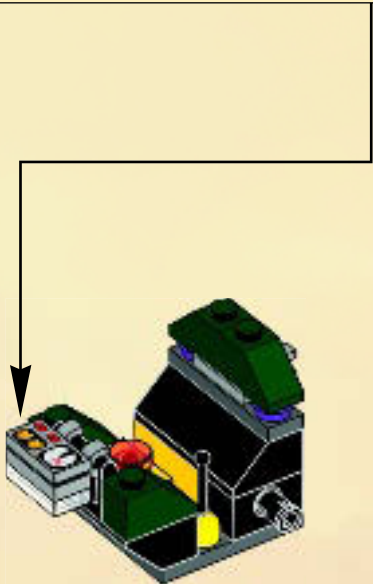
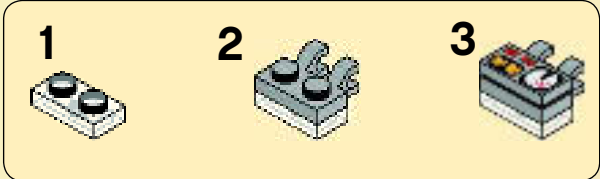



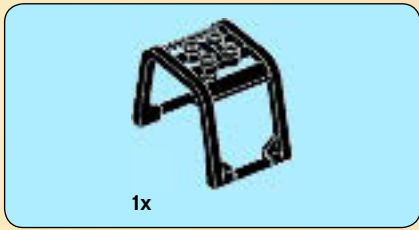

12

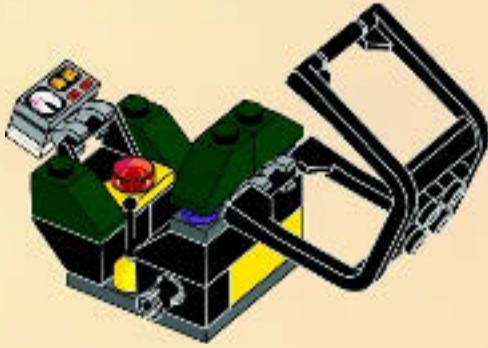

13

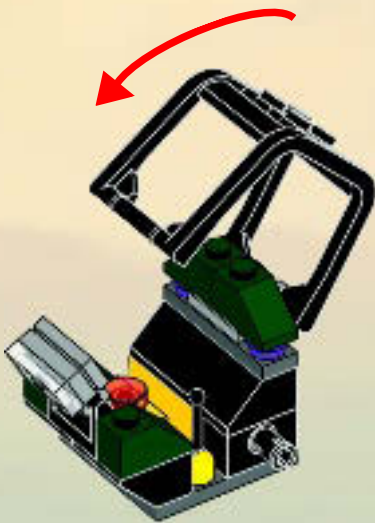

14

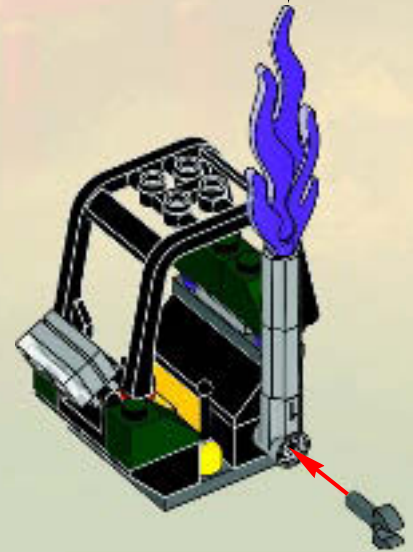
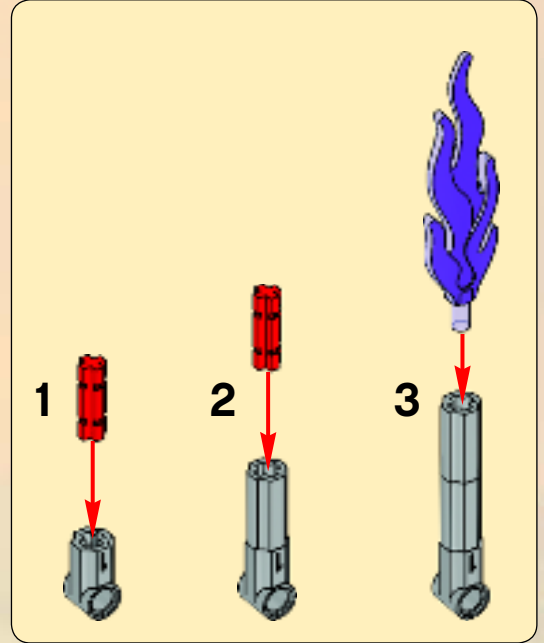

34



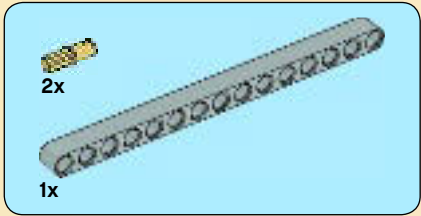
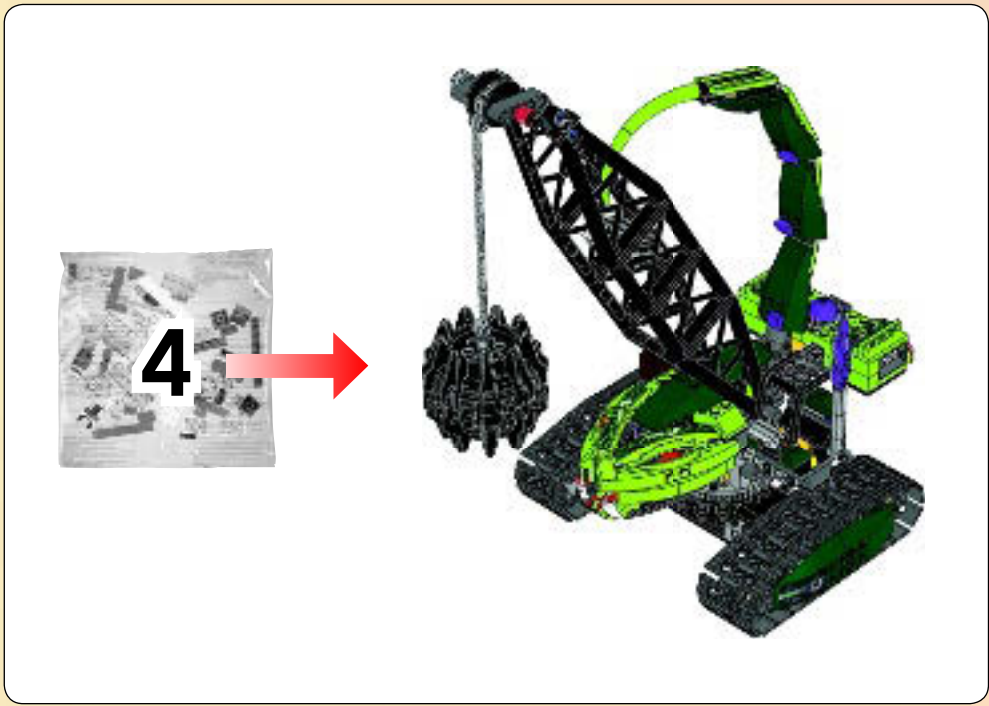

1

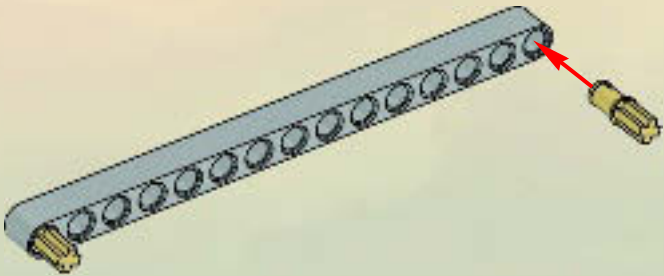

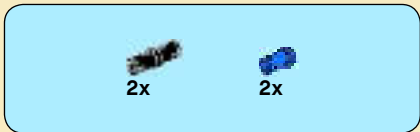

2

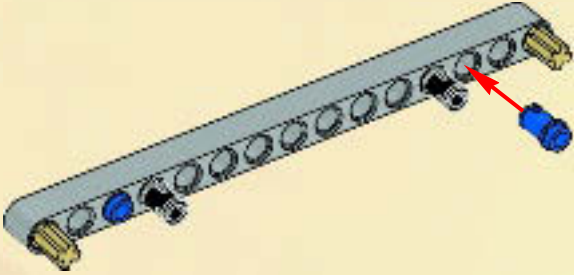

4

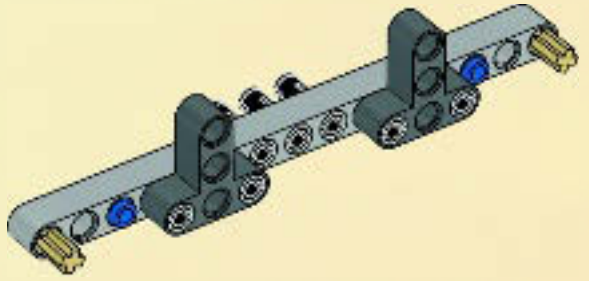

3

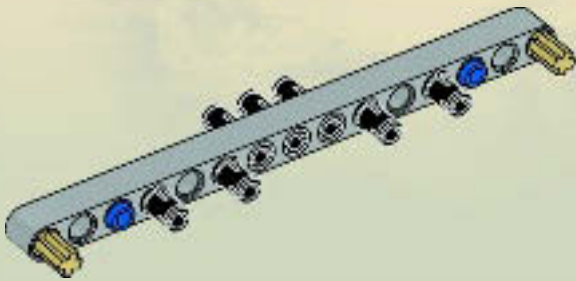

5

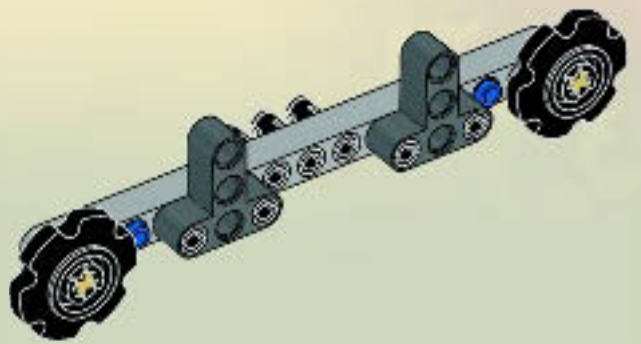



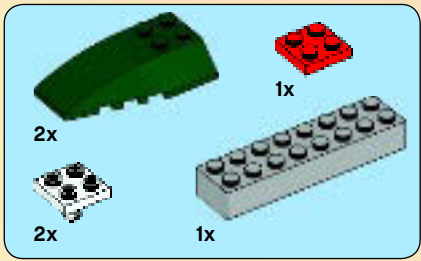

6

1

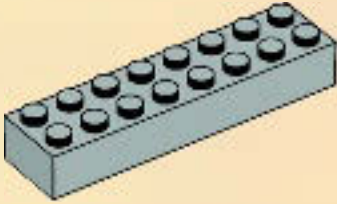

2

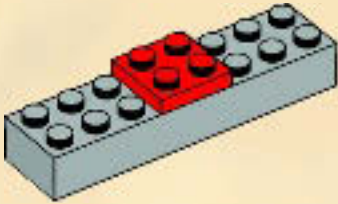

3

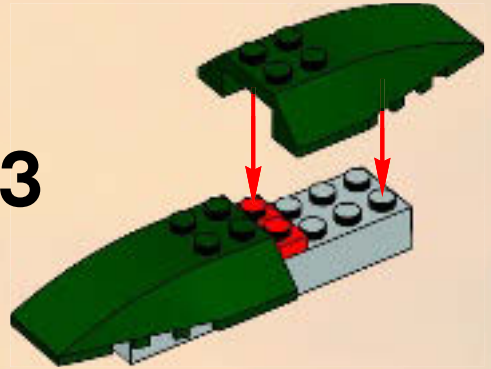

4

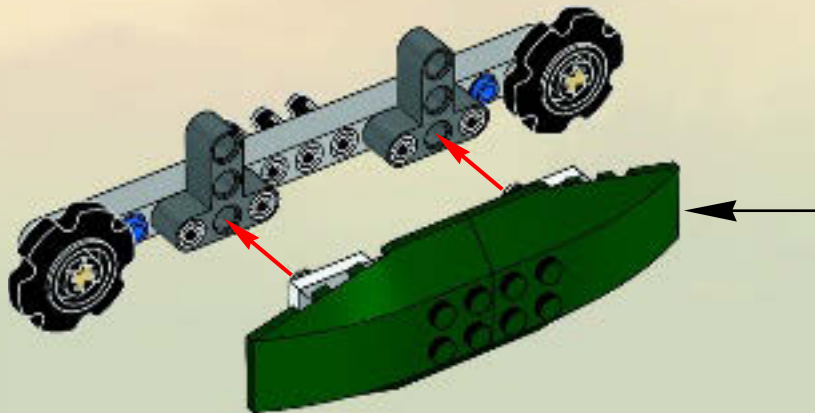
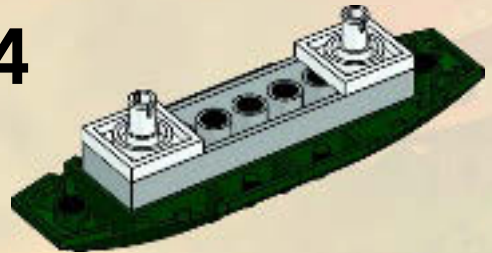

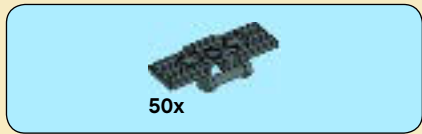

7

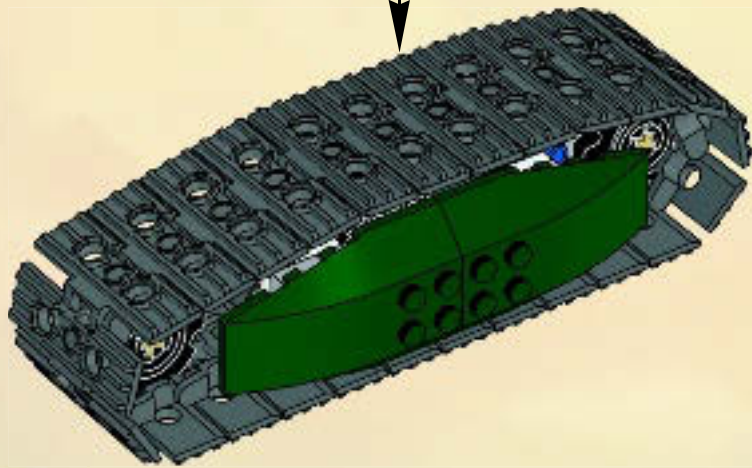
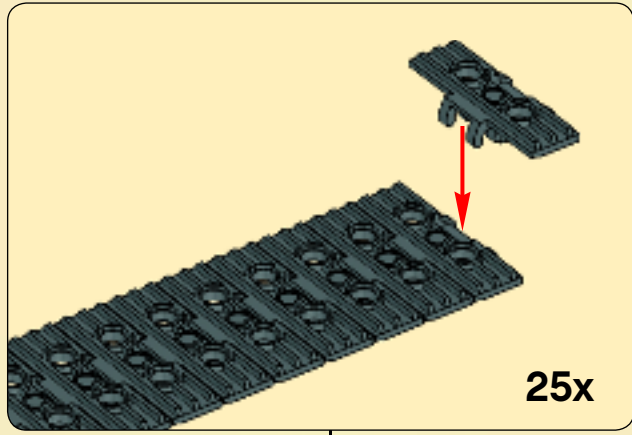

2x

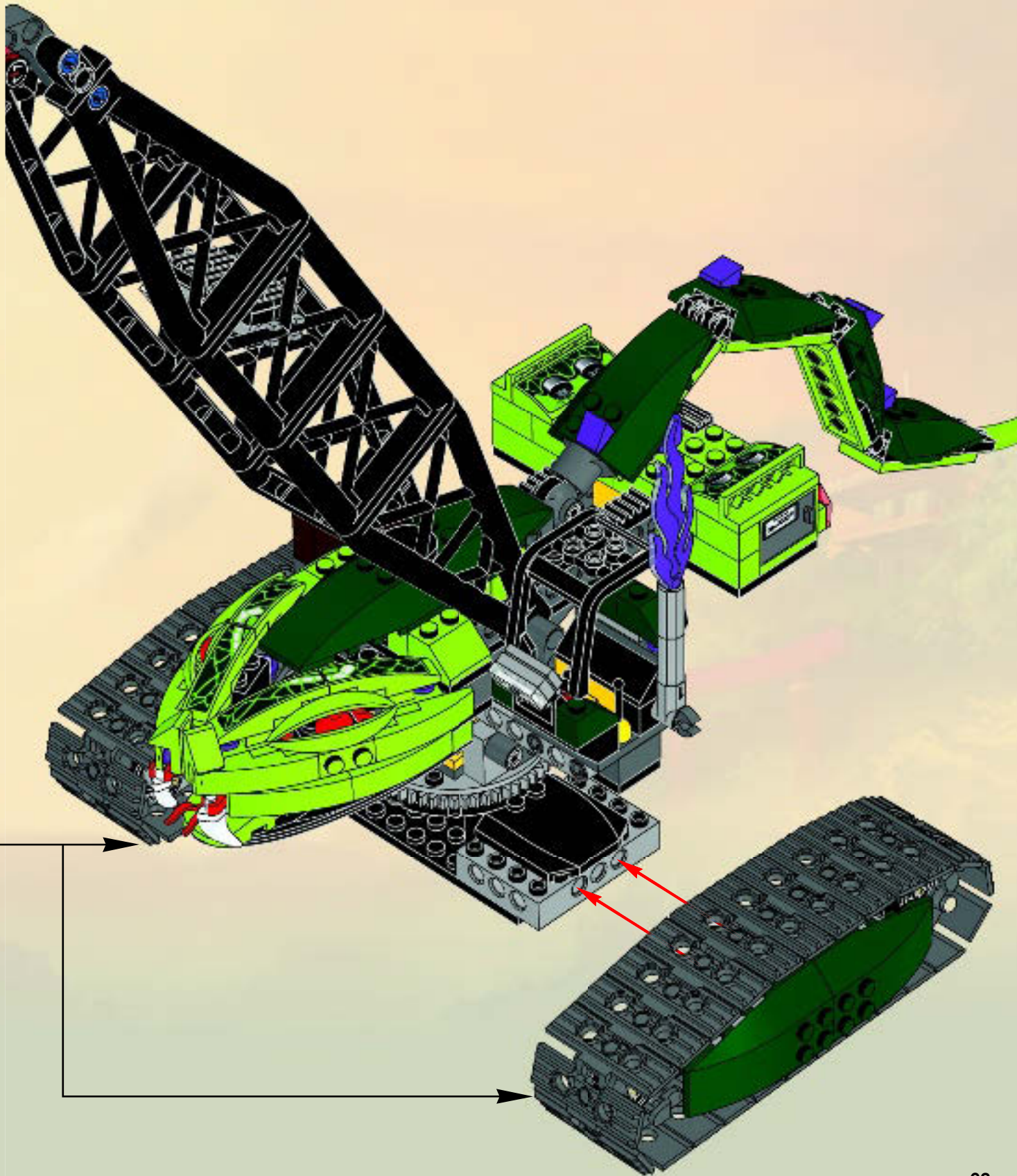



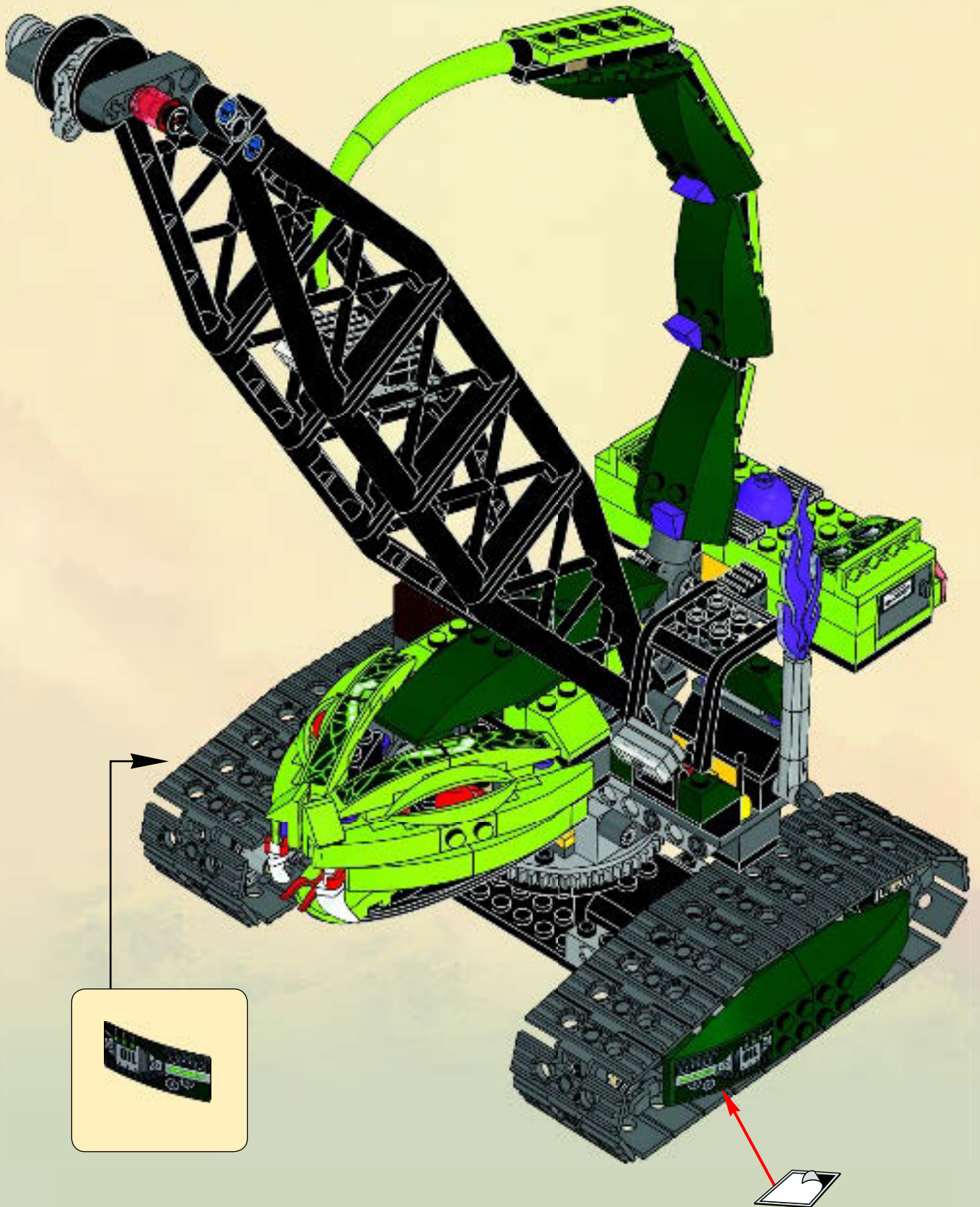



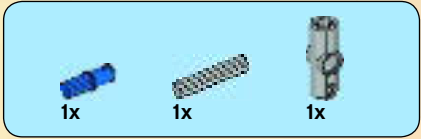

1

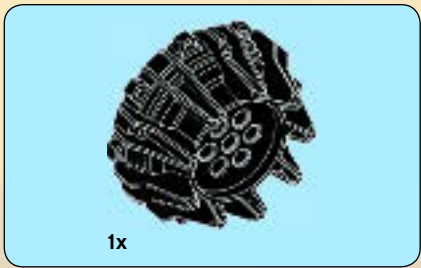

2

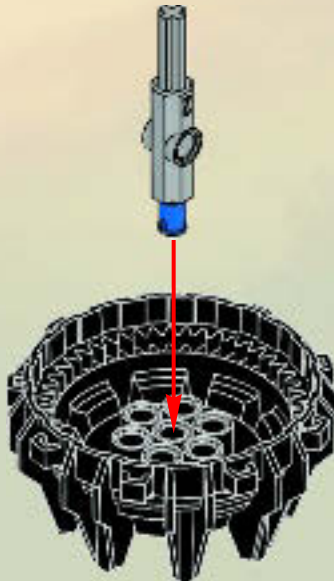

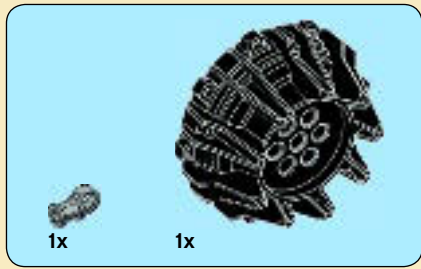

3

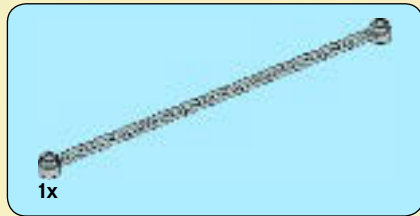
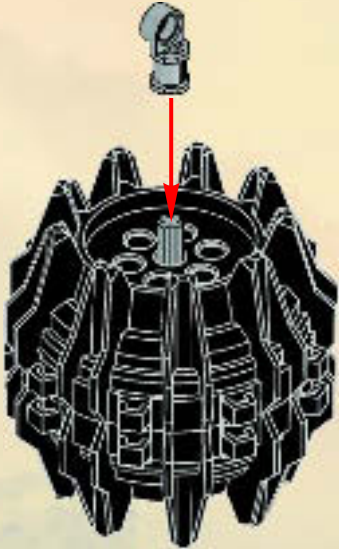

4

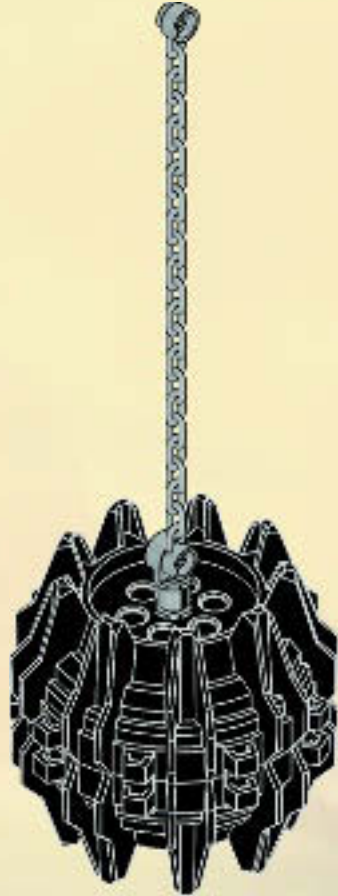













2x  
4233486



4x  
4293876



2x  
4566256



1x  
4113993



1x  
4217562



4x  
4666579



1x  
300321



2x  
4520782



6x  
302221



2x  
4588003



1x  
4140585



2x  
4534648



1x  
449521



1x  
4648092



1x  
4647443



1x  
4648360



2x  
4652568



2x  
4290714



14x  
4142865



4x  
4143005



3x  
4206482



2x  
4514553



2x  
300224



2x  
371024



1x  
379424



2x  
4183981



1x  
74156



1x  
4611426



1x  
4647015



2x  
362226



2x  
4288212



6x  
4265484



1x  
370026



2x  
366026



1x  
303726



4x  
302026



2x  
4191191



4x  
4659404



2x  
4191191



4x  
4659404



2x  
4191191



4x  
4659404



1x  
302926



1x  
302826



1x  
415026



2x  
4144024



3x  
241226



1x  
244426



6x  
4183060



1x  
243226



1x  
4596914



1x  
4646676



1x  
4612652



1x  
4667794



1x  
4277668



1x  
4277668



1x  
4651017



1x  
4603189



2x  
303226



2x  
303426



4x  
4655570



1x  
4539385



1x  
4213374



5x  
4205760



1x  
4490248

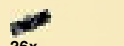

26x  
4121715



2x  
4526982



2x  
4218868



2x  
4538782

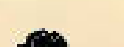

4x  
4662228

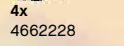

2x  
4167842

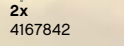

1x  
3006841

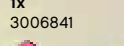

2x  
4244363

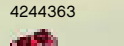

2x  
4201019



2x  
4189801



2x  
4653402

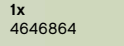

1x  
4646864



  
**Customer Service**  
**Kundenservice**  
**Service Consommateurs**  
**Servicio Al Consumidor**  
[www.lego.com/service](http://www.lego.com/service) or dial  
 : 00800 5346 5555  
 : 1-800-422-5346





# NINJAGO

Masters of Spinjitzu



**KENDO ZANE**  
9563 - 9446



**KENDO KAI**  
9568



**KENDO COLE**  
9551



**COLE ZX**  
9579 - 9444



**ZANE ZX**  
9440  
9445



**JAY ZX**  
9553  
9442  
9445



**SAMURAI X**  
9566



**LLOYD GARMADON**  
9552 - 9443



**FANG-SUEI**  
9567 - 9443



**FANGDAM**  
9445



**LASHA**  
9562



**RATTLA**  
9579 - 9441



**SNAPPA**  
9564 - 9442





# NINJAGO

Masters of Spinjitzu



[NINJAGO.COM](http://NINJAGO.COM)





# NINJAGO

Masters of Spinjitzu



[NINJAGO.COM](http://NINJAGO.COM)



**LEGO club**™

**FREE! GRATIS! GRATUIT!**



**www.LEGOclub.com**



**LEGO® Club Magazine**



**LEGO® Club Email**

**SIGN UP ONLINE!**  
**www.LEGOclub.com**

VISIT THE WORLD'S  
BIGGEST LEGO® SHOP!

**www.LEGOshop.com**

GO TO  
**www.LEGOclub.com**

**00800 5346 5555\***

**1-866-534-6258 • 1-877-518-5346**

US & Canada only

Canada seulement



\* Freephone. Mobile charges may apply. \* Numéro sans frais. Des frais peuvent s'appliquer avec les téléphones cellulaires. \* Gebührenfrei, Kosten für Anrufe aus Mobilfunknetzen können abweichen. \* Gratis telefoonnummer vanaf vaste lijn. \* Det er et gratis nummer, når du ringer fra fasttelefon. \* Det är gratis, när du ringer från en fast telefon. \* Numéro sans frais. Des frais peuvent s'appliquer avec les téléphones portables.





# WIN!

Go to [www.LEGOsurvey.com/product](http://www.LEGOsurvey.com/product) to fill out a survey for a chance to win a cool LEGO® Product.

No purchase necessary.

Open to all residents where not prohibited.



[www.LEGO.com](http://www.LEGO.com)



## [www.LEGOsurvey.com/product](http://www.LEGOsurvey.com/product)

### GEWINNE!

Nimm an der Umfrage auf [www.LEGOsurvey.com/product](http://www.LEGOsurvey.com/product) teil und hab die Chance ein cooles LEGO® Produkt zu gewinnen!

Die Teilnahme am Gewinnspiel führt zu keinerlei Kaufverpflichtungen. Teilnahme in allen nicht ausgeschlossenen Ländern möglich.

### WIN!

Ga naar [www.LEGOsurvey.com/product](http://www.LEGOsurvey.com/product), vul een enquêteformulier in en maak kans op een cool LEGO® product.

Geen aankoopverplichting. Iedereen mag deelnemen, uitgezonderd ingezetenden van landen waar een enquêteverbod geldt.

### GAGNE!

Visite [www.LEGOsurvey.com/product](http://www.LEGOsurvey.com/product) pour répondre à un questionnaire et avoir une chance de gagner un produit LEGO® très cool!

Aucune obligation d'achat. Ouvert à tous les résidents des pays autorisés.

### 当てよう!

[www.LEGOsurvey.com/product](http://www.LEGOsurvey.com/product) にアクセスして、アンケートにご記入ください。当選者にはレゴ製品を差し上げます。

お買い上げの必要はありません。禁止されていない限り、すべての皆様にご利用いただけます。