



# STAR WARS



9493



1

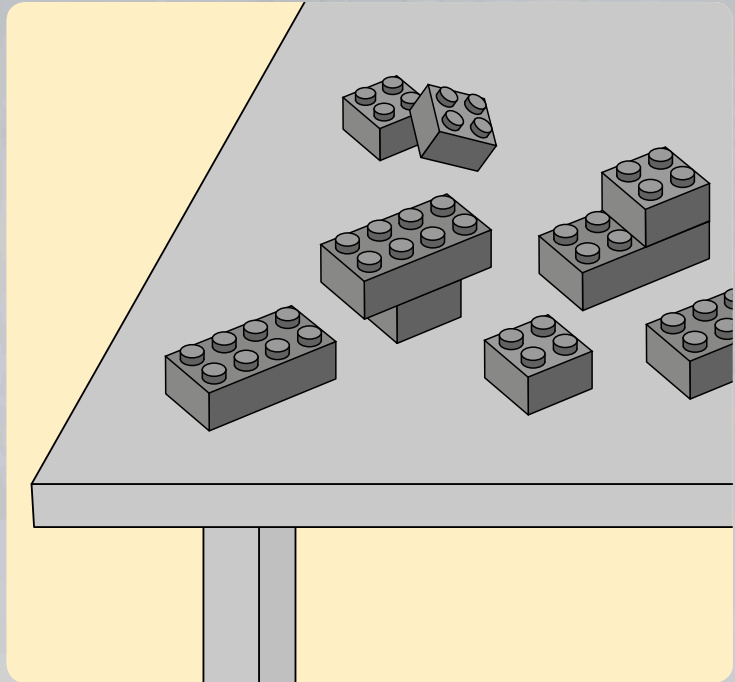
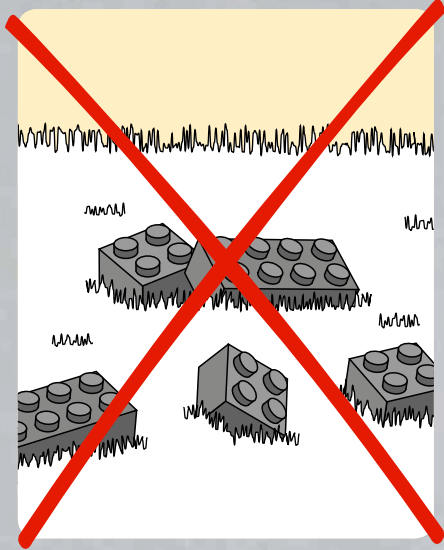

2

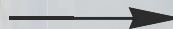

2



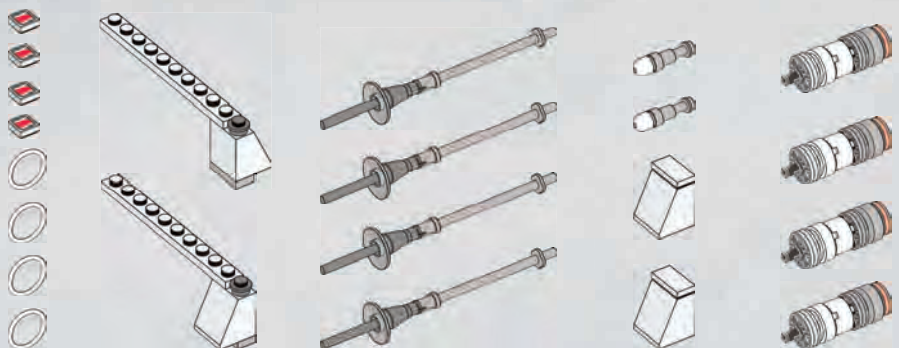
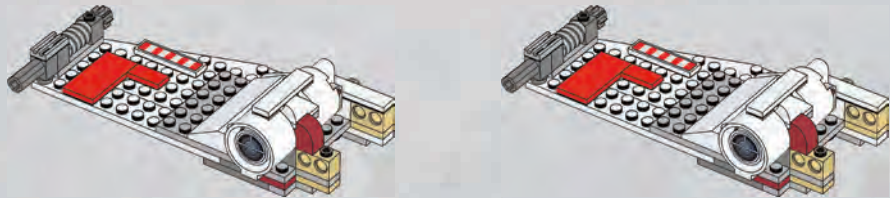
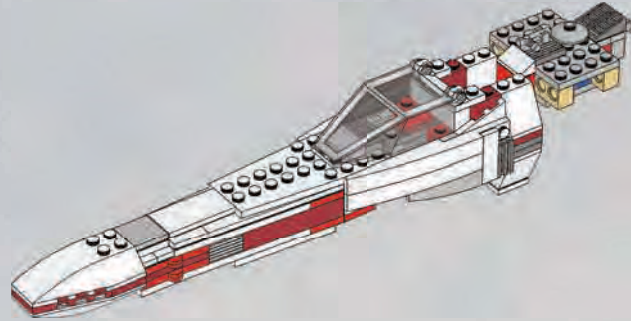
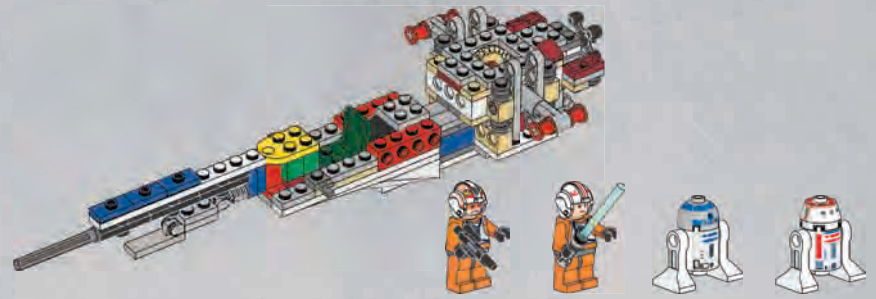

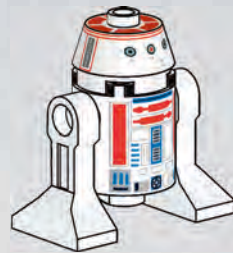
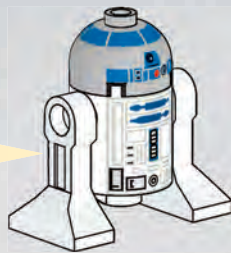
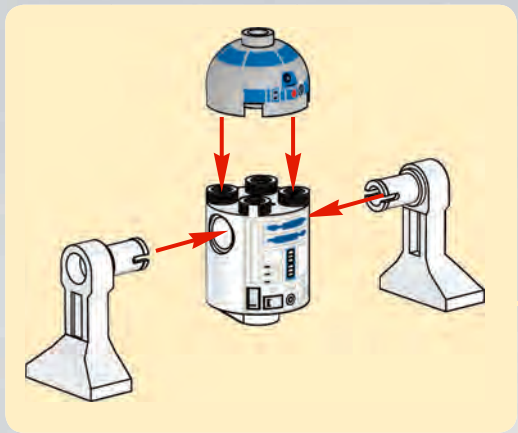
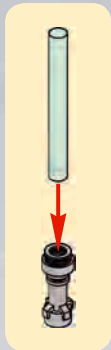
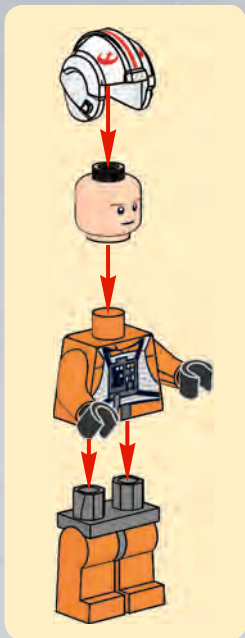
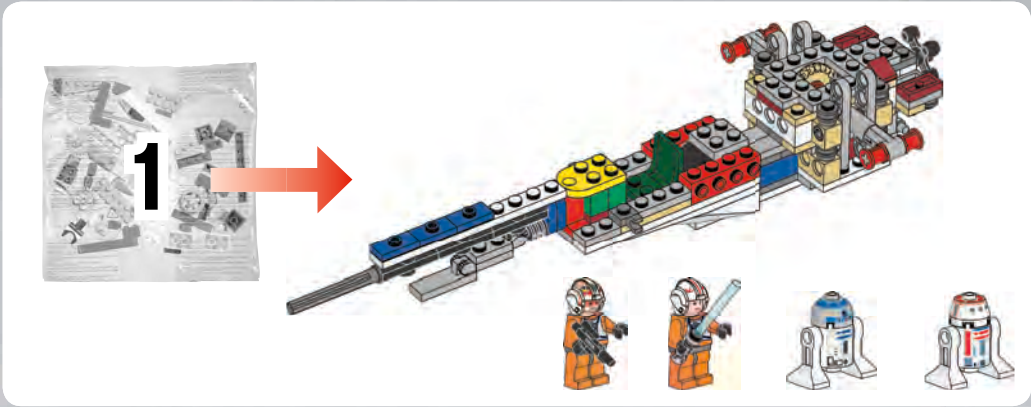



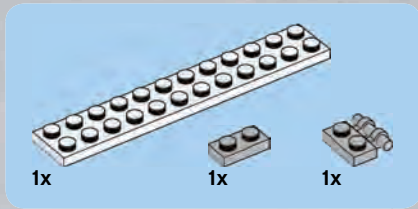

1

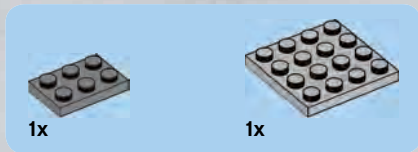
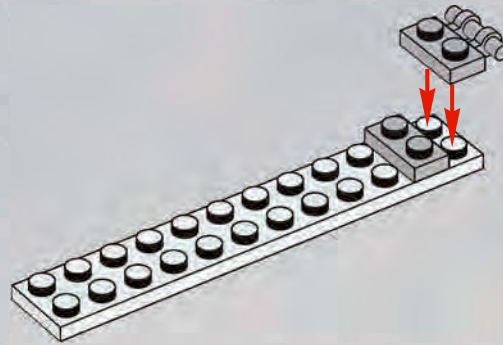

2

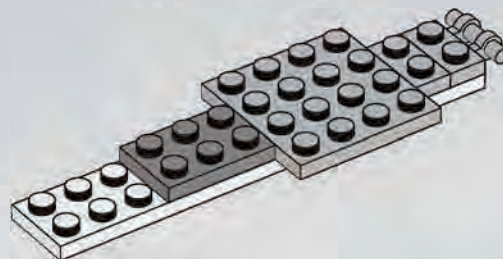

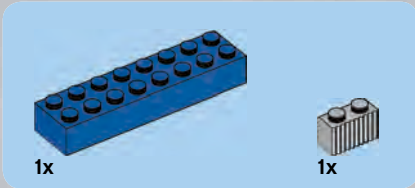

3

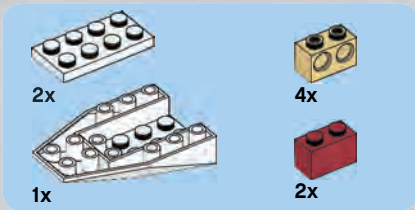
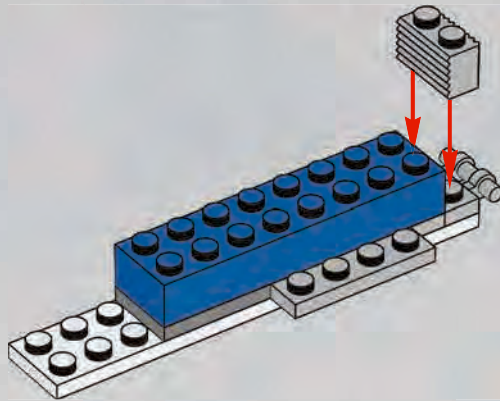

4

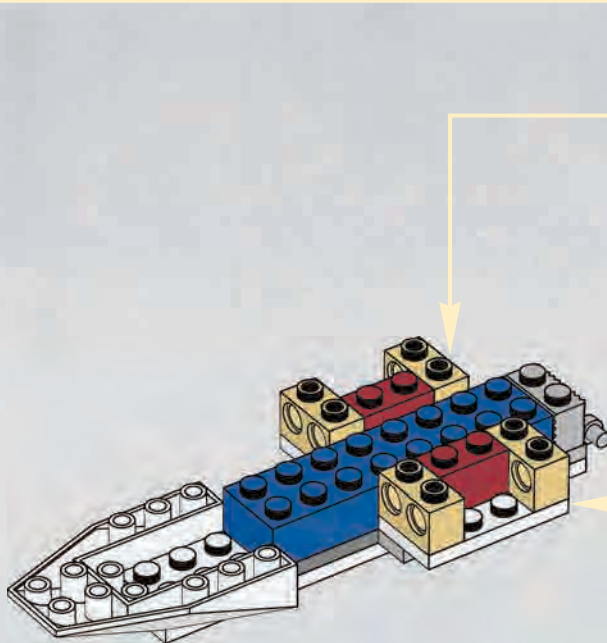
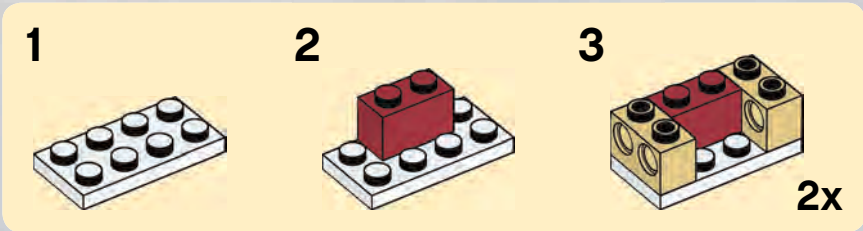

6



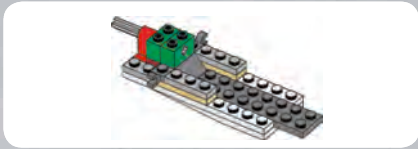

1

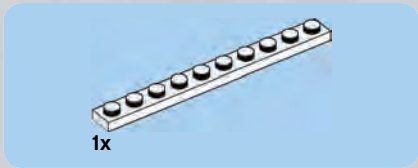
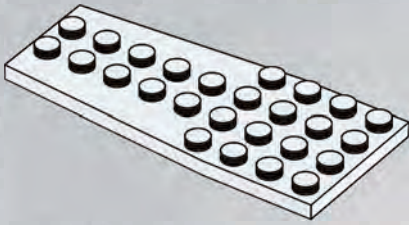

2

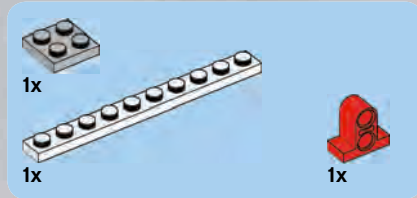
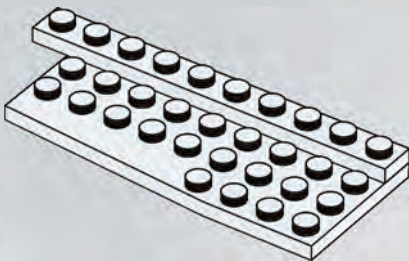

3

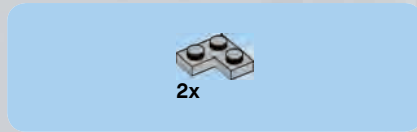
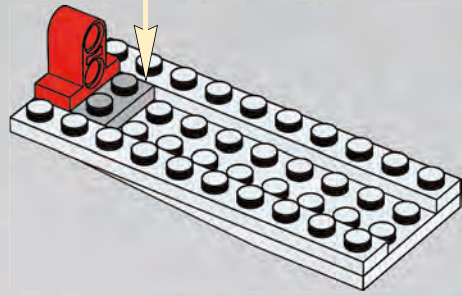
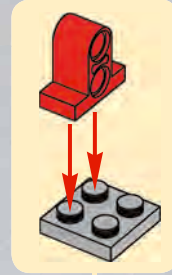

4

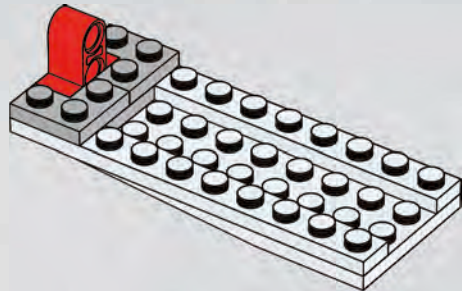



2x



1x

5

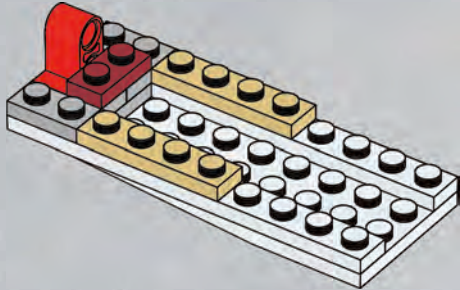

1x



1x

6

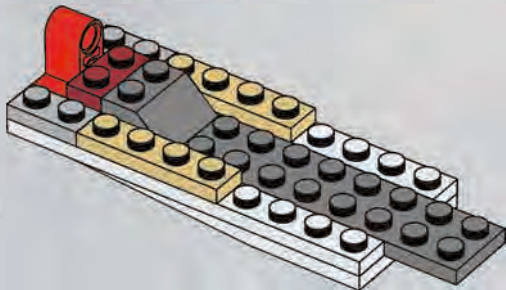

2x



2x

7

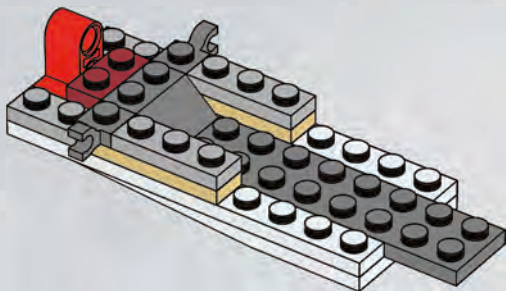

8



2x

8

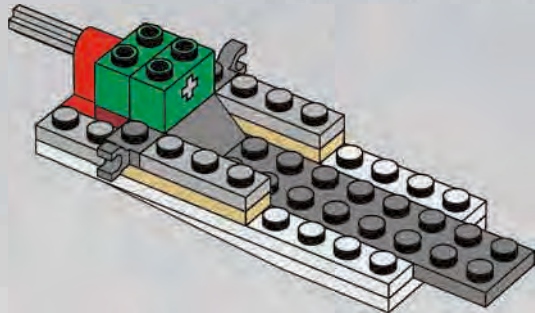

5



1x

9

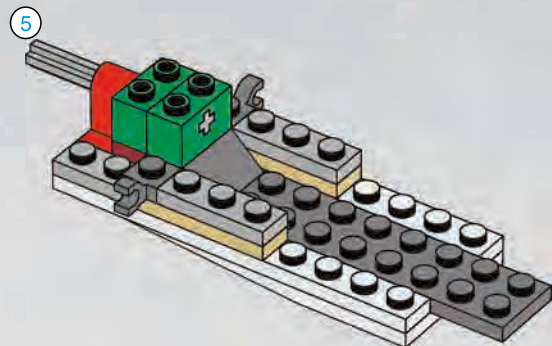

5



5

1:1



5

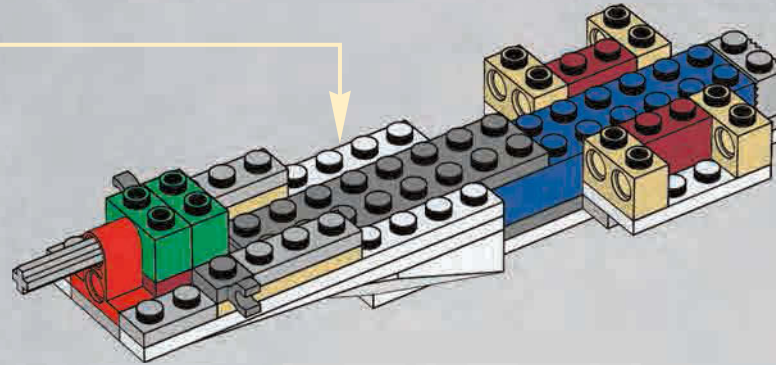

6

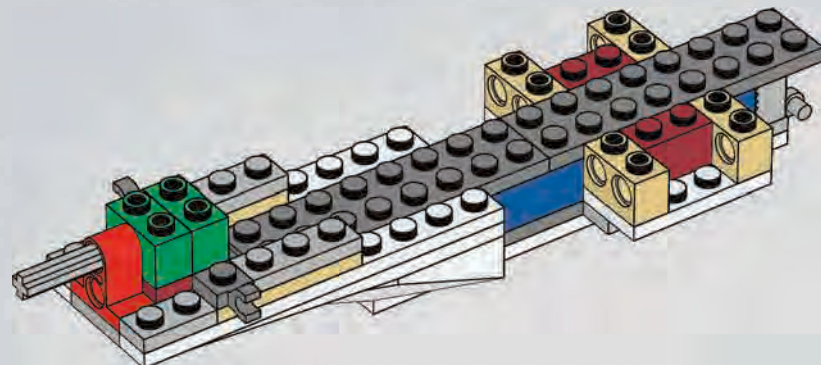

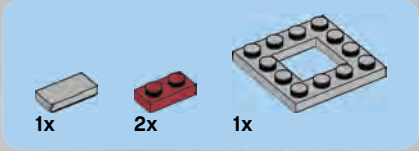

7

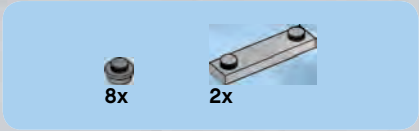
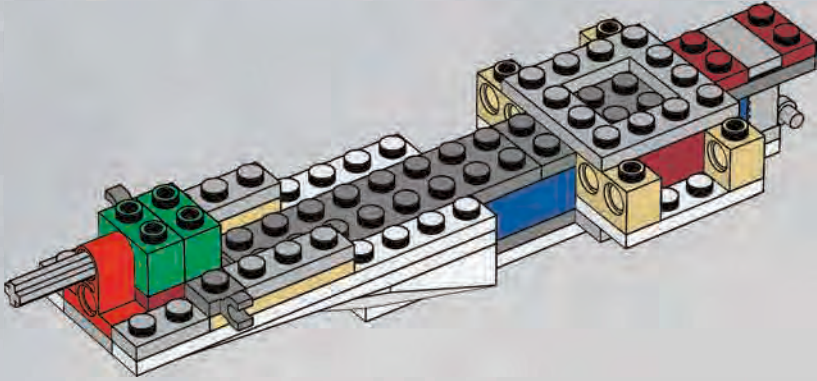

8

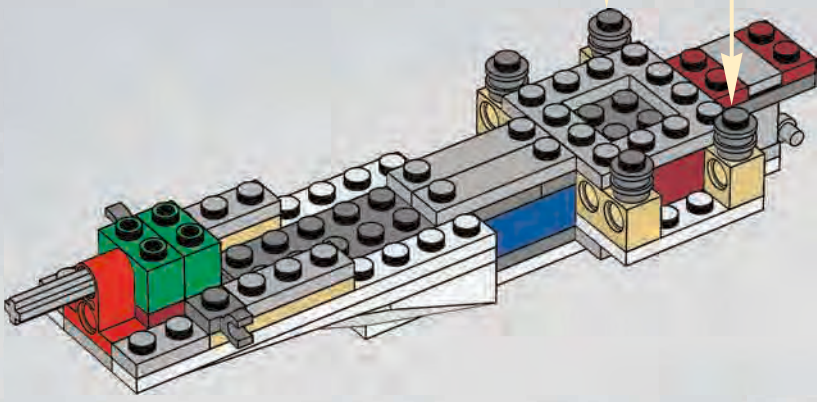
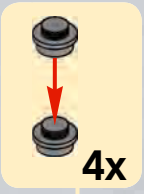

10





2x



2x

# 9

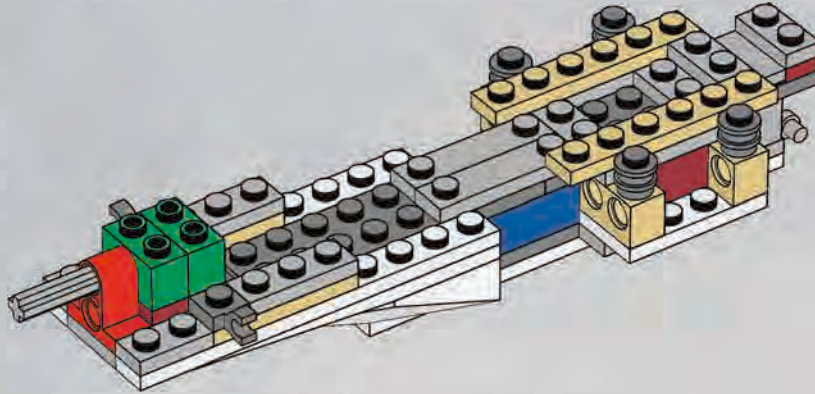

1x



1x

# 10

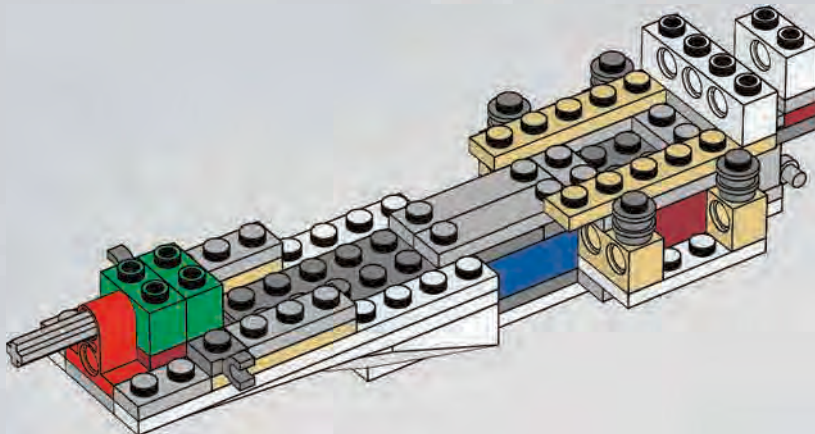

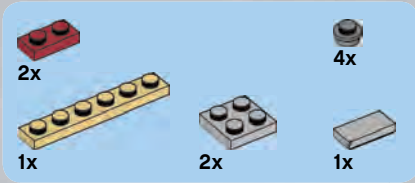

# 11

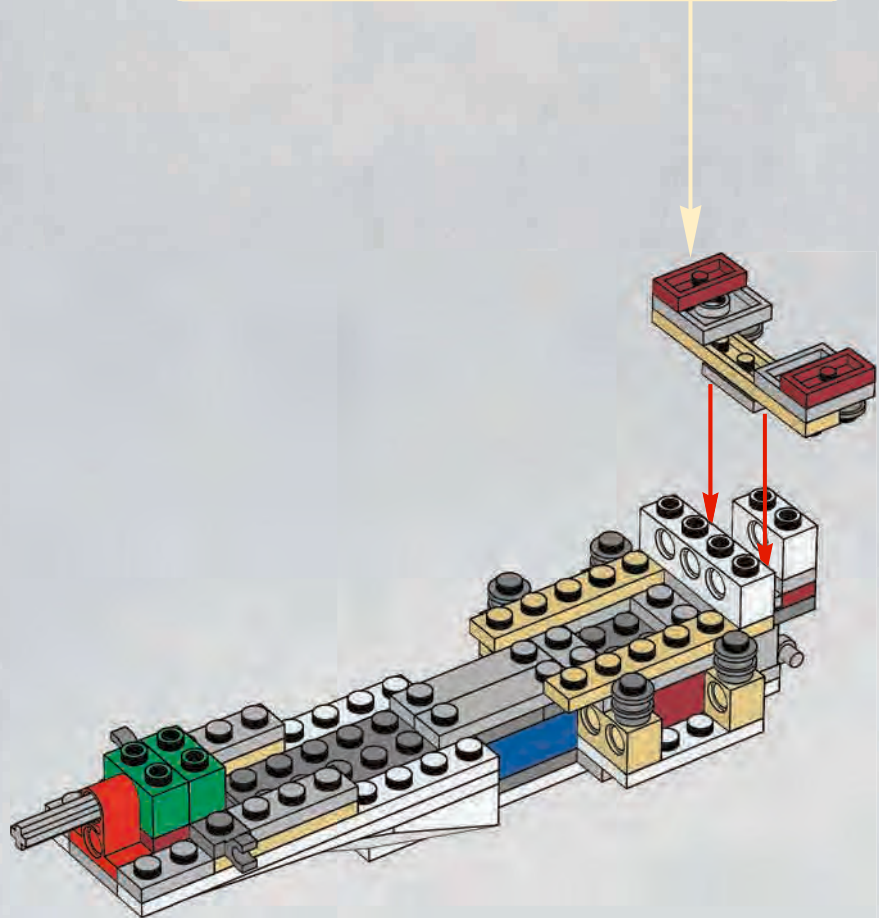
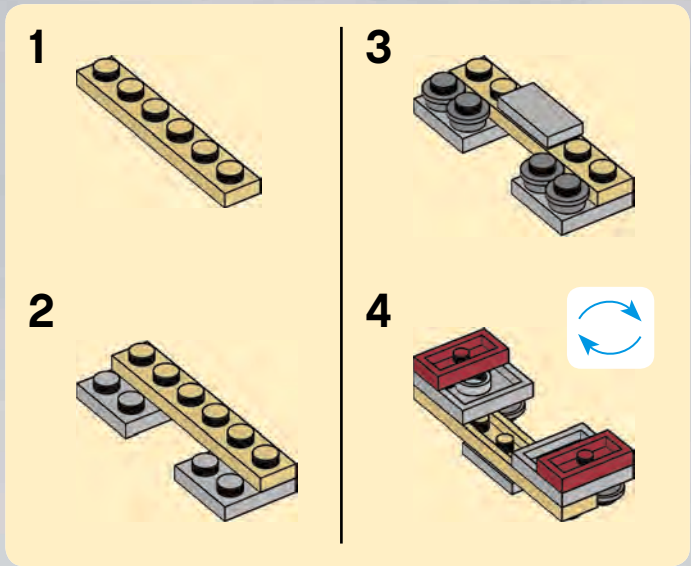





# 12

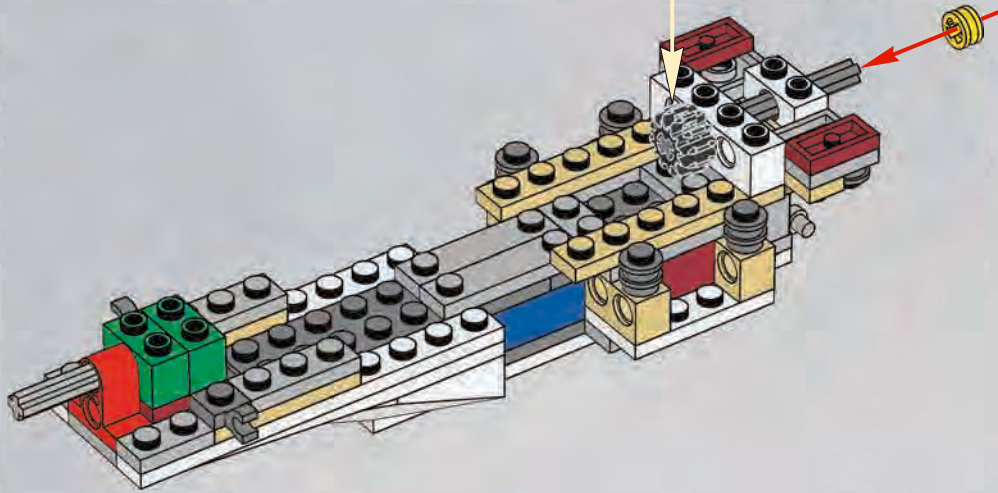
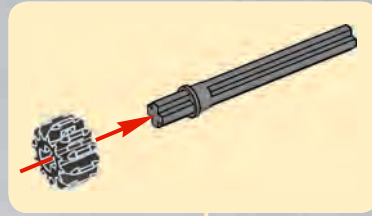

# 13

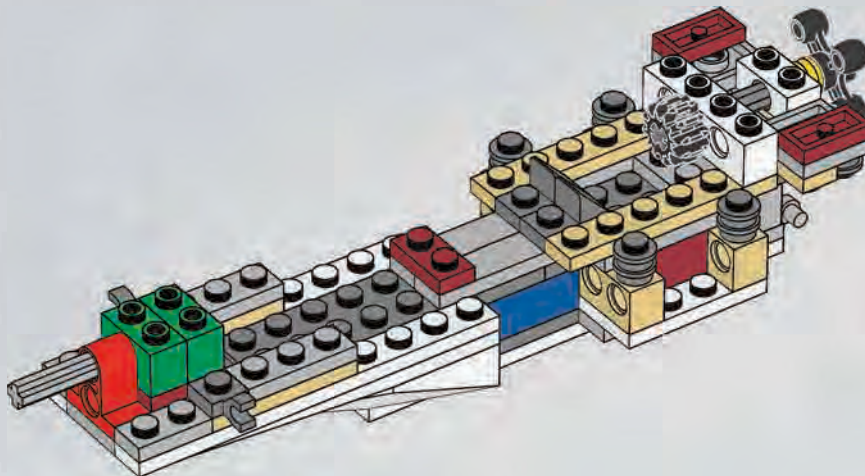

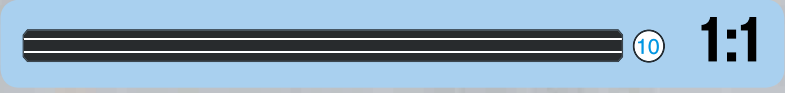
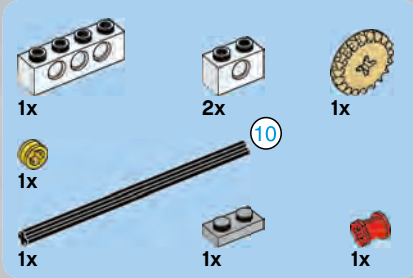

# 14

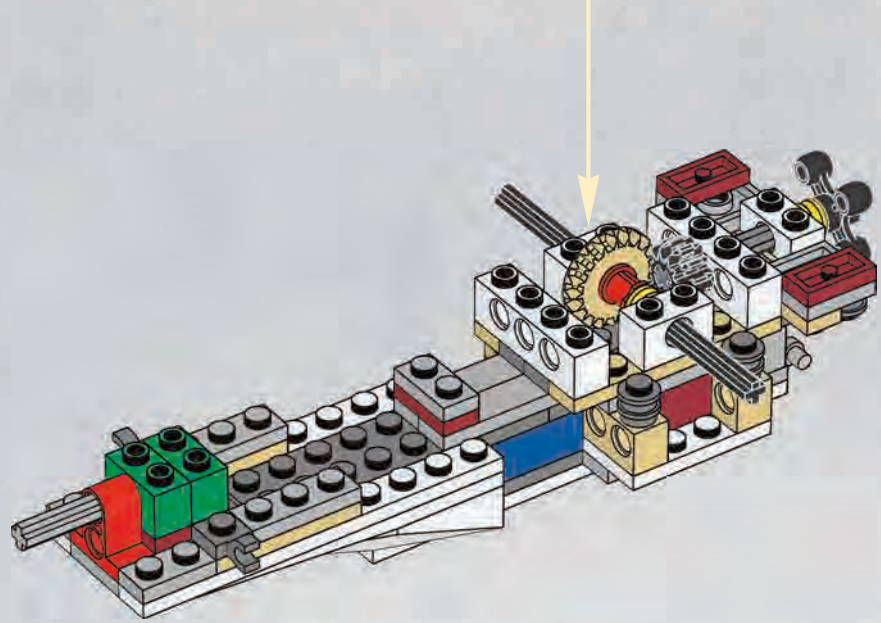
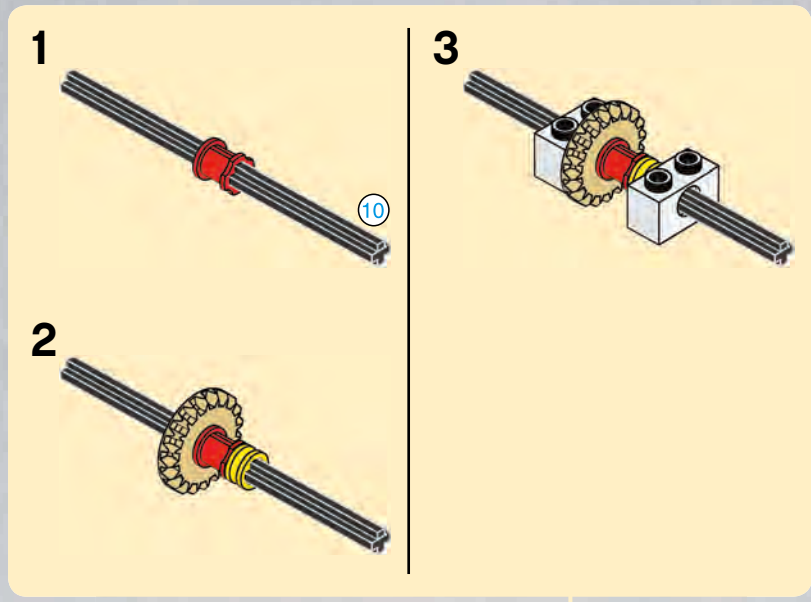



15

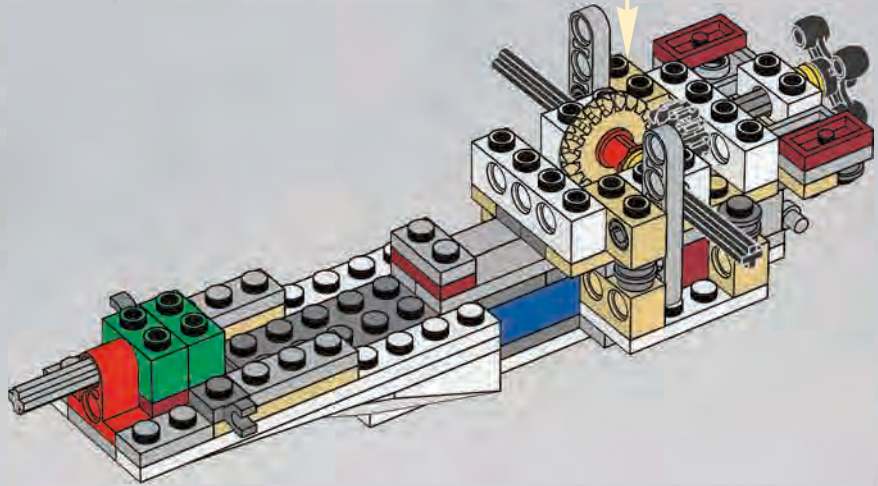
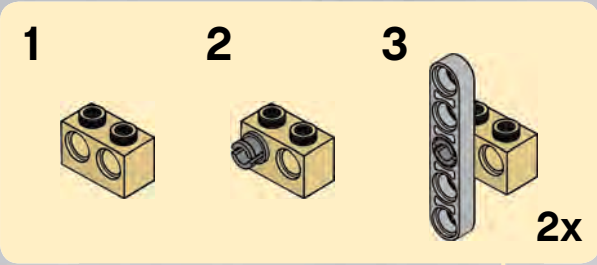

16

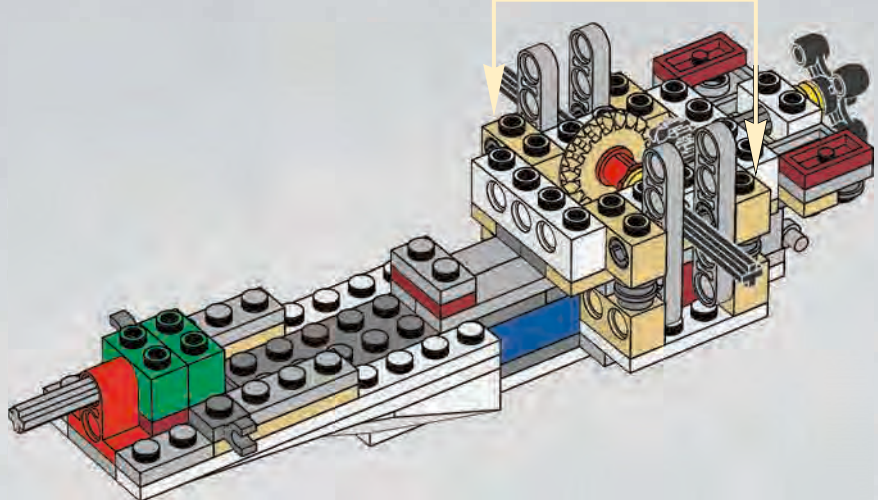
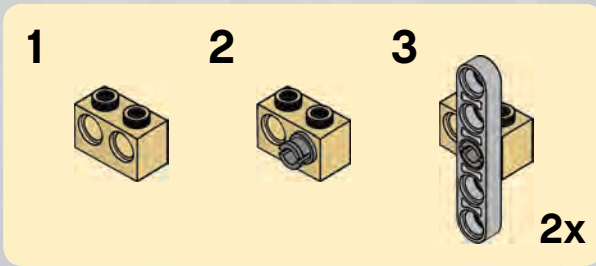





2x

# 17

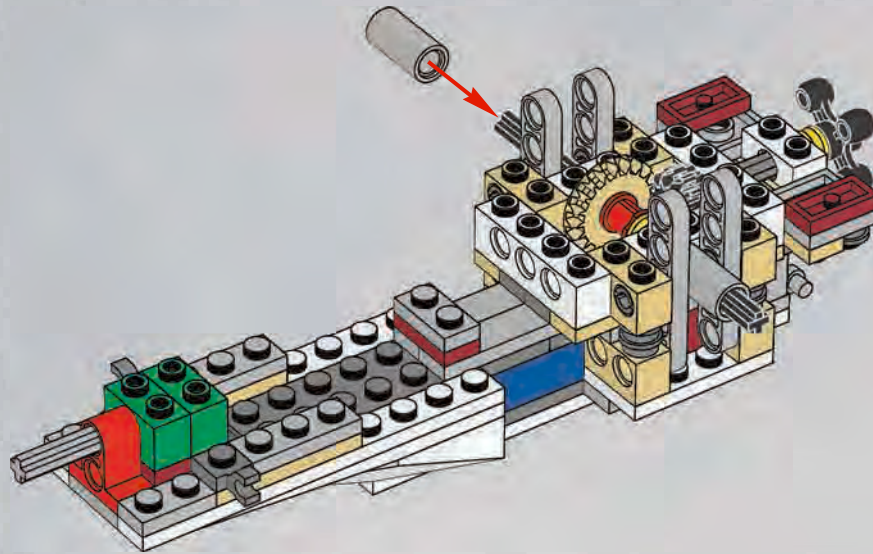

2x



2x



4x

# 18

1

3



2

3

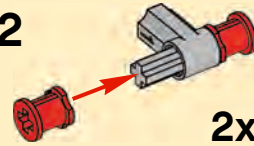

2x

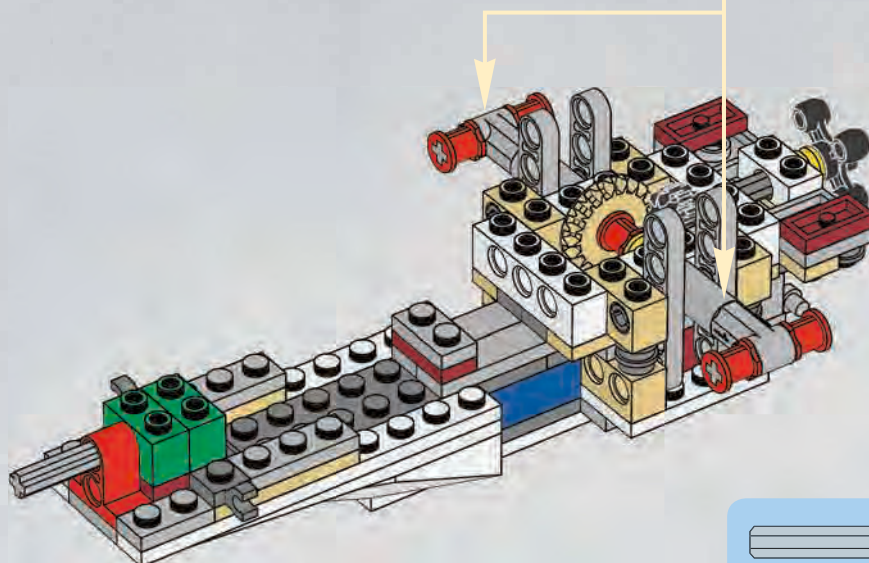

3

# 1:1

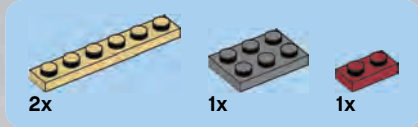

# 19

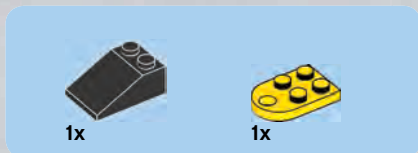
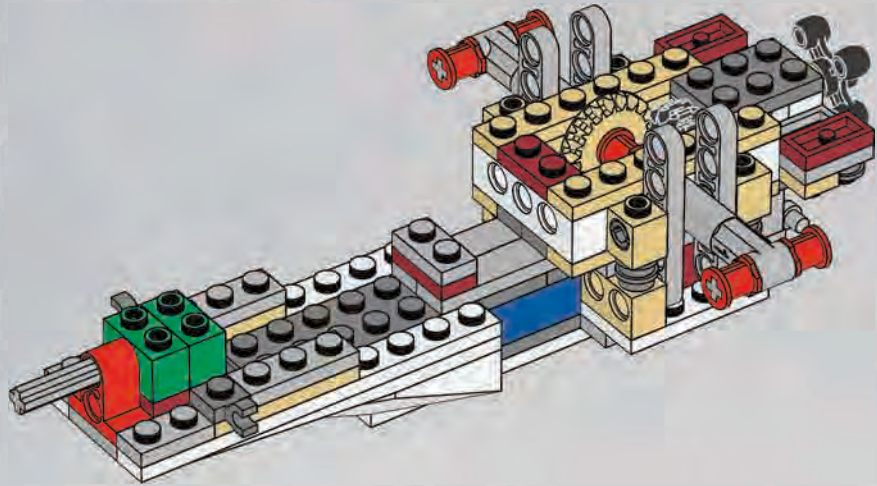

# 20

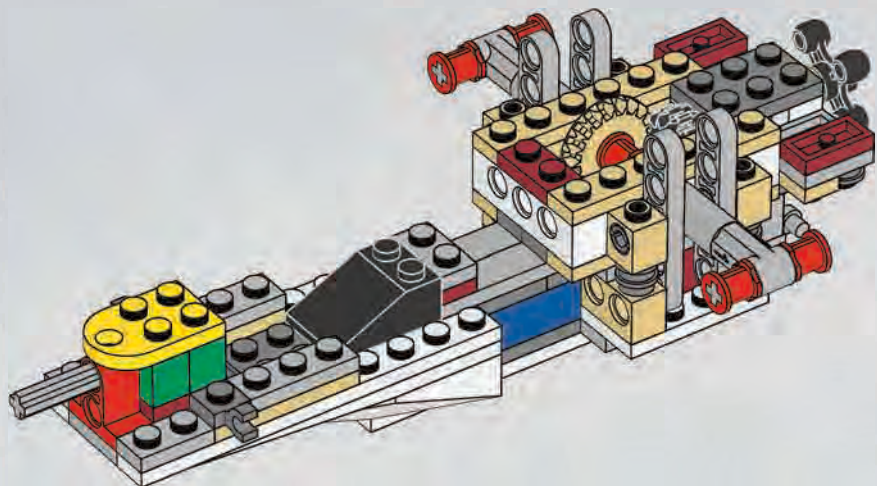



2x



1x

# 21

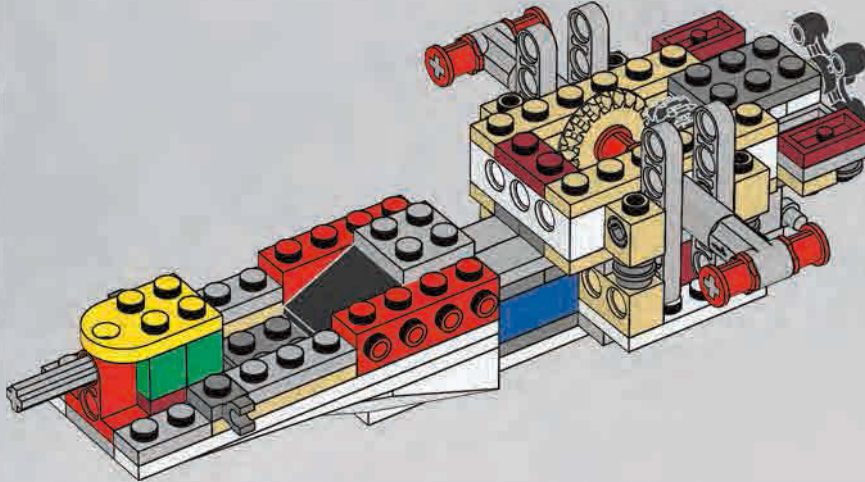

1x



8x



2x

# 22



4x

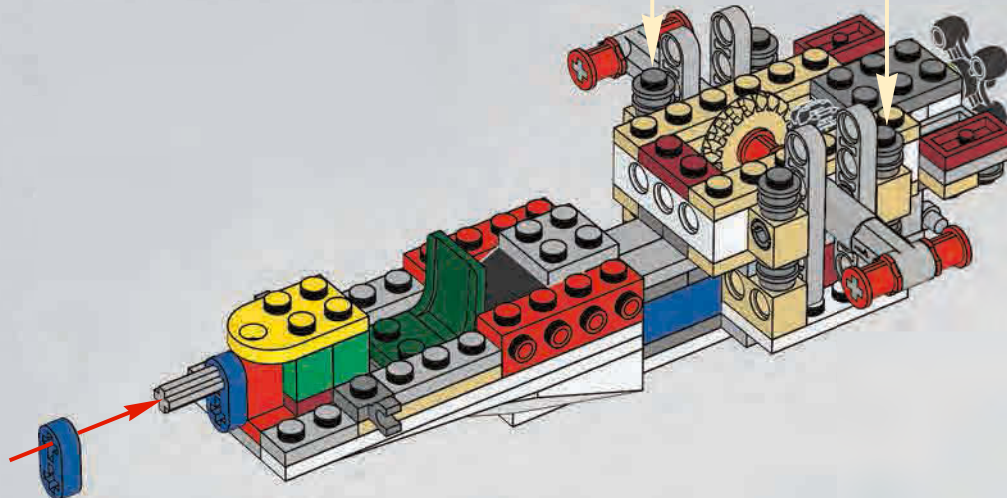



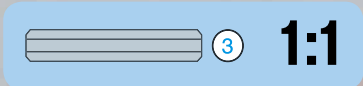
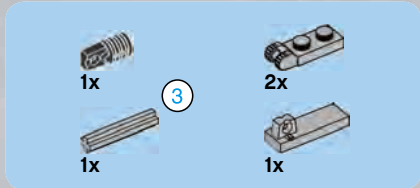

23

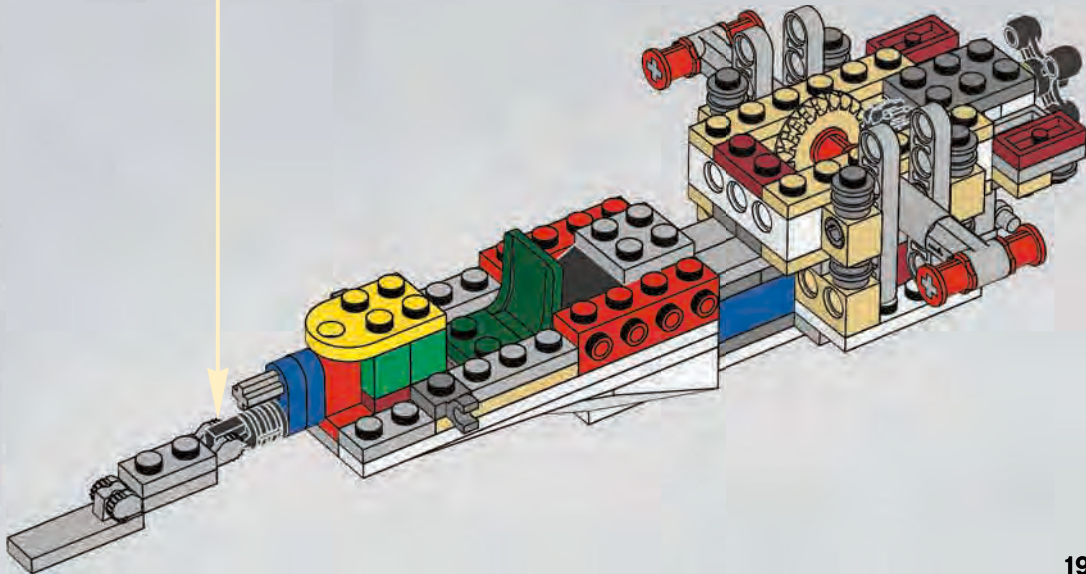
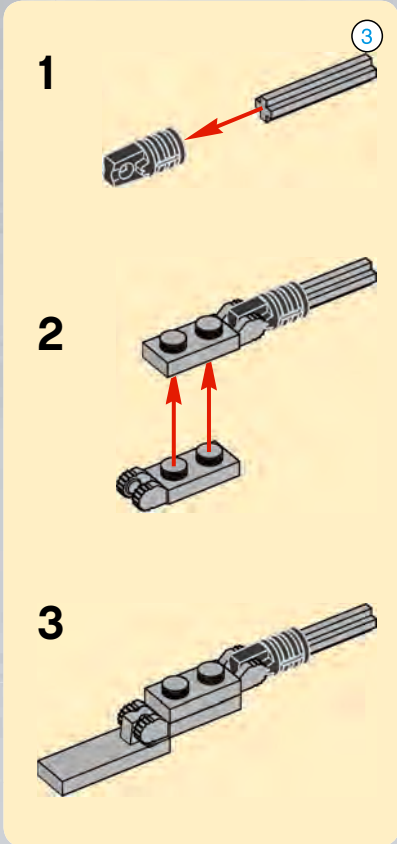

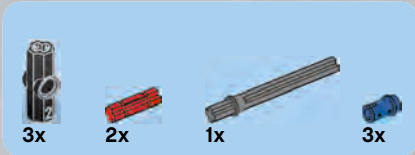

# 24

1



2



3



4

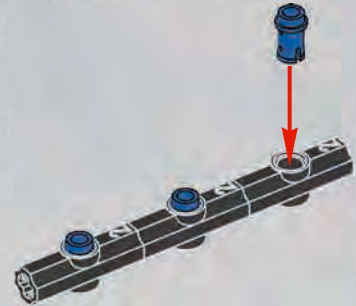

5

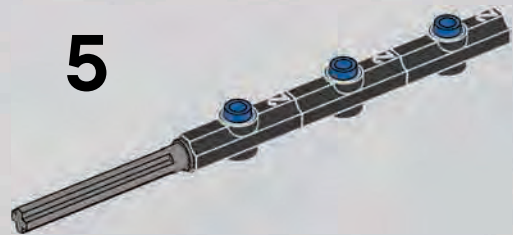

20

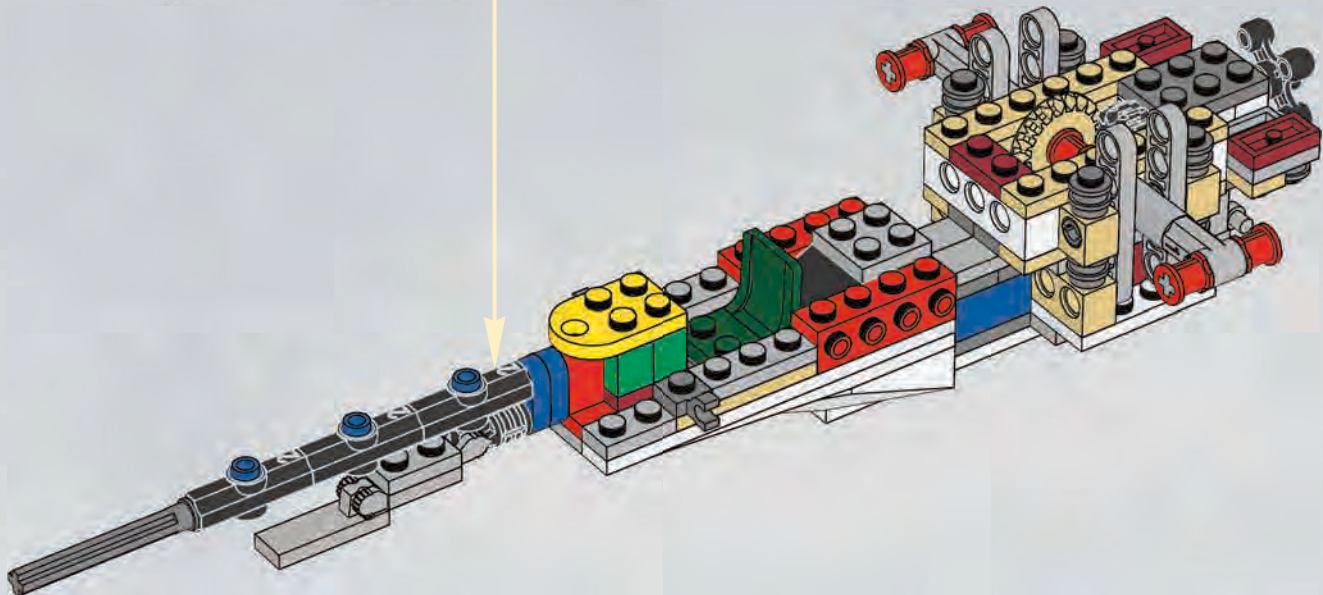





# 25

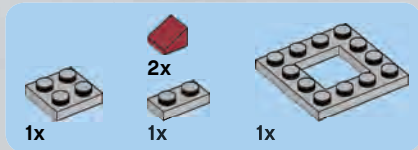
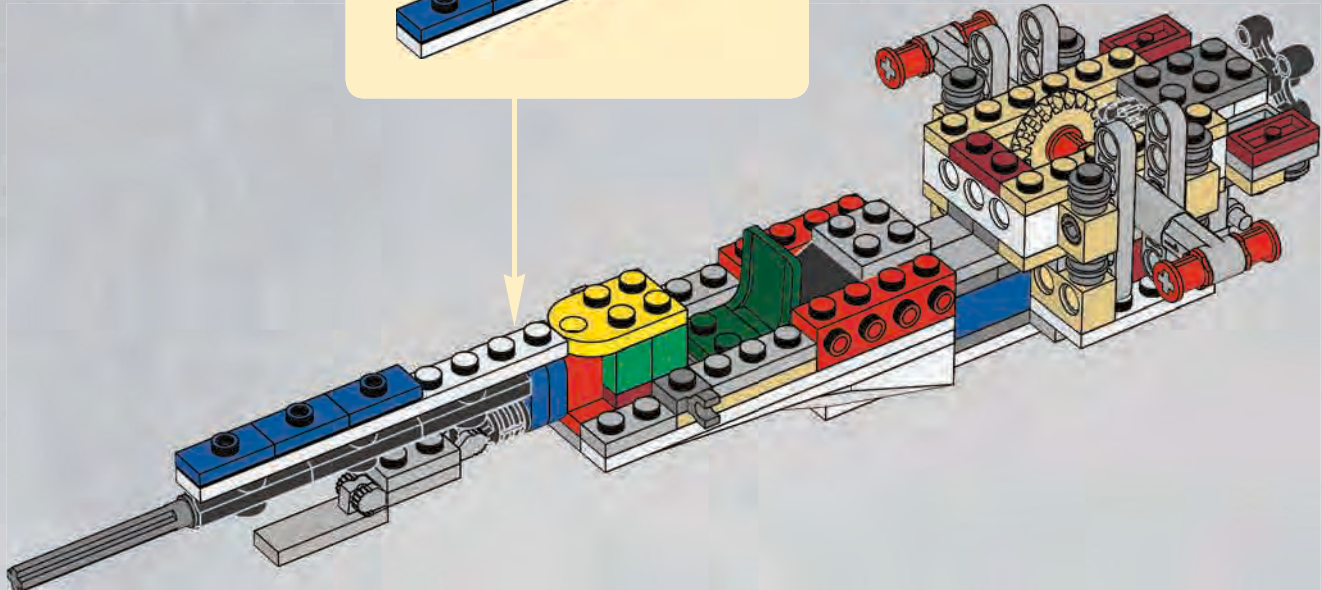
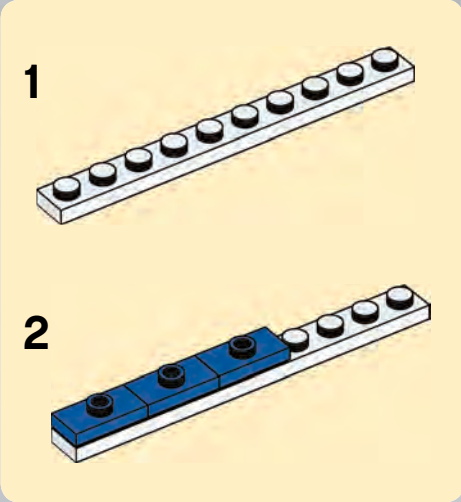

# 26

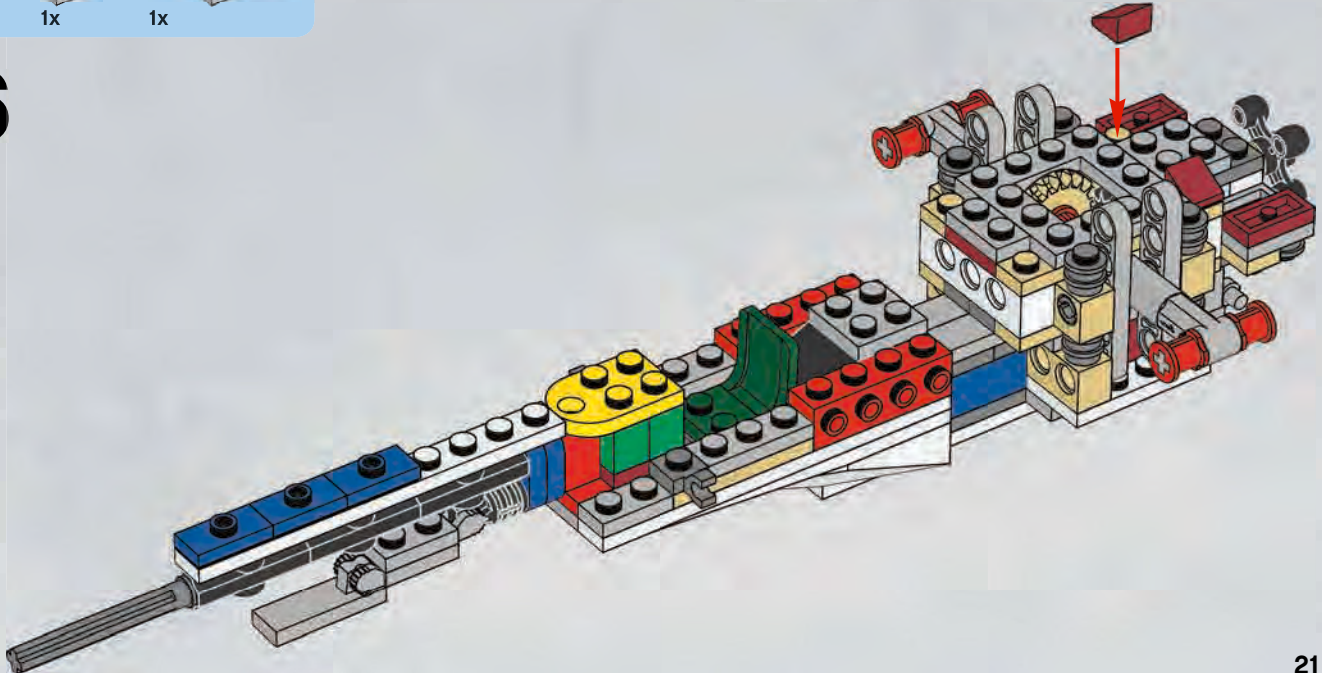



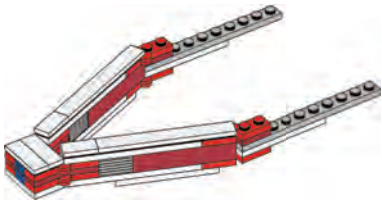
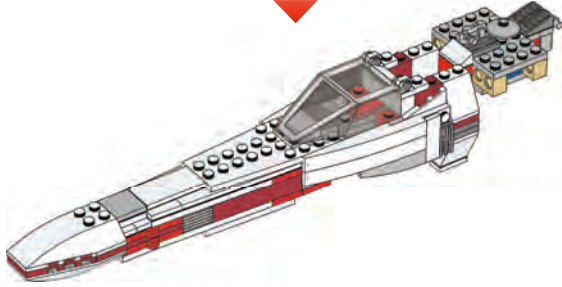

1x

1



2x

2

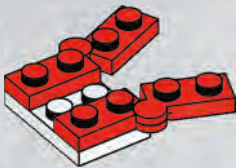

22



2x



2x

3

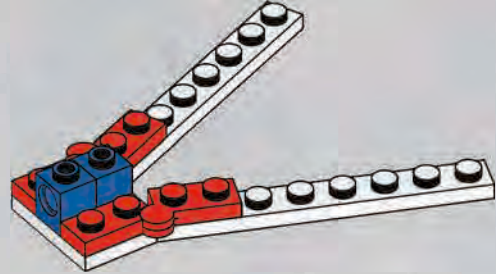

4x

4

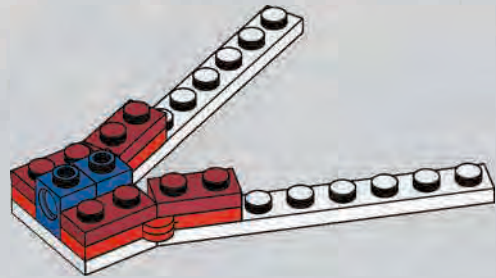

2x



2x

5

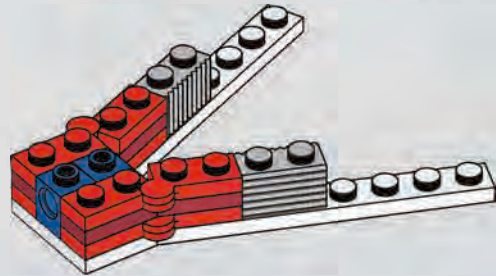



6

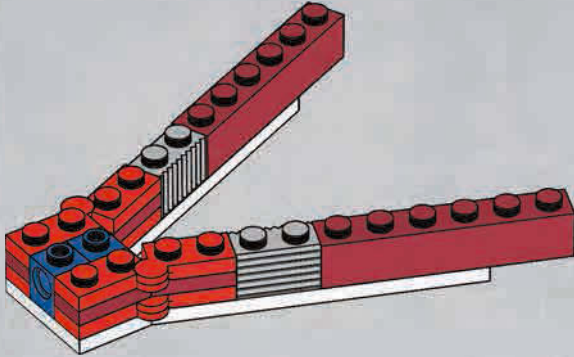

7

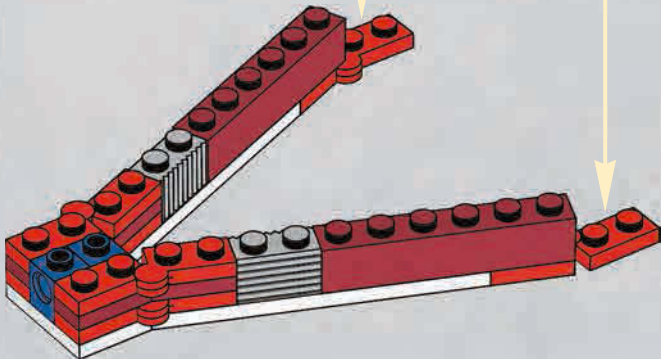

8

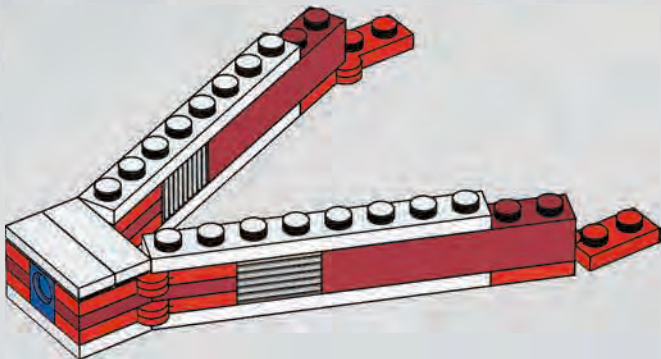

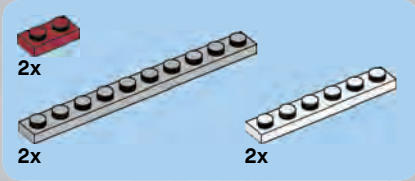

9

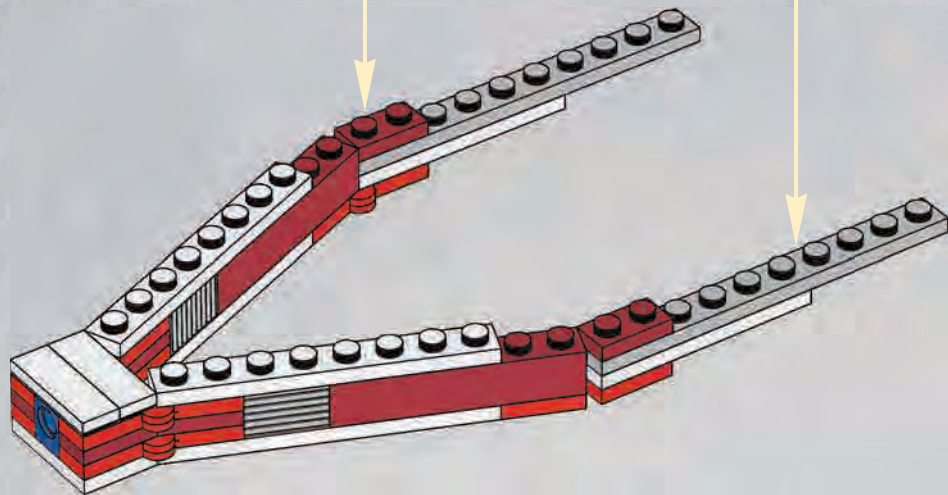
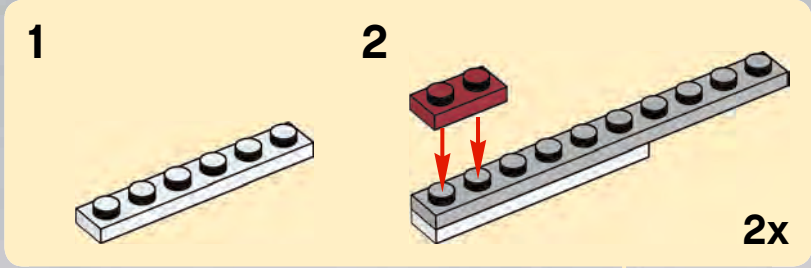

10

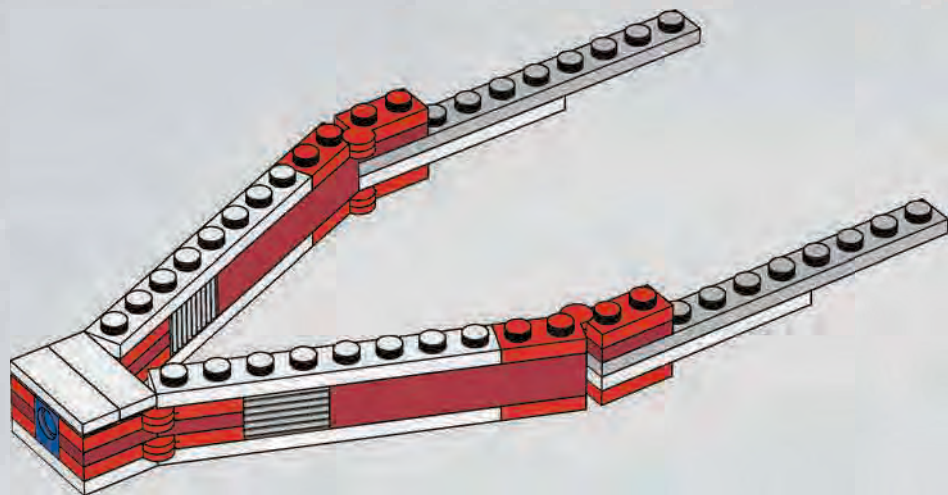





2x

# 11

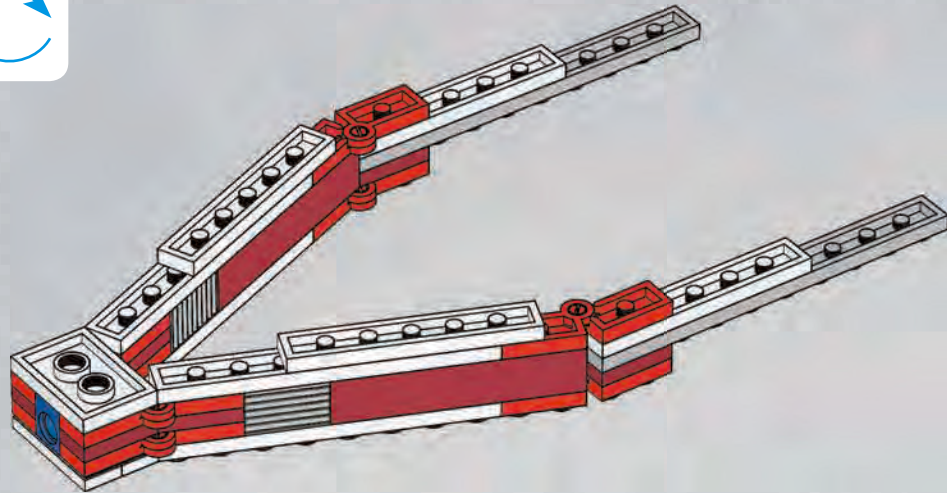

2x



2x

# 12

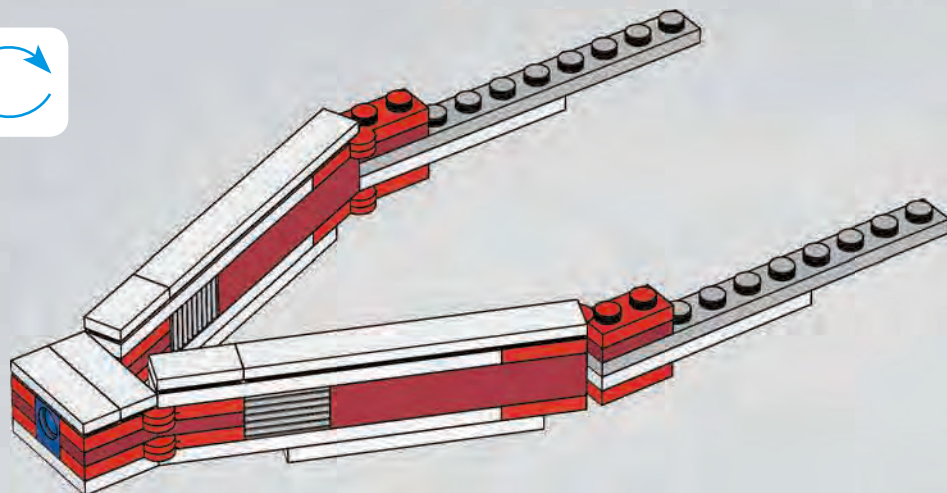

13

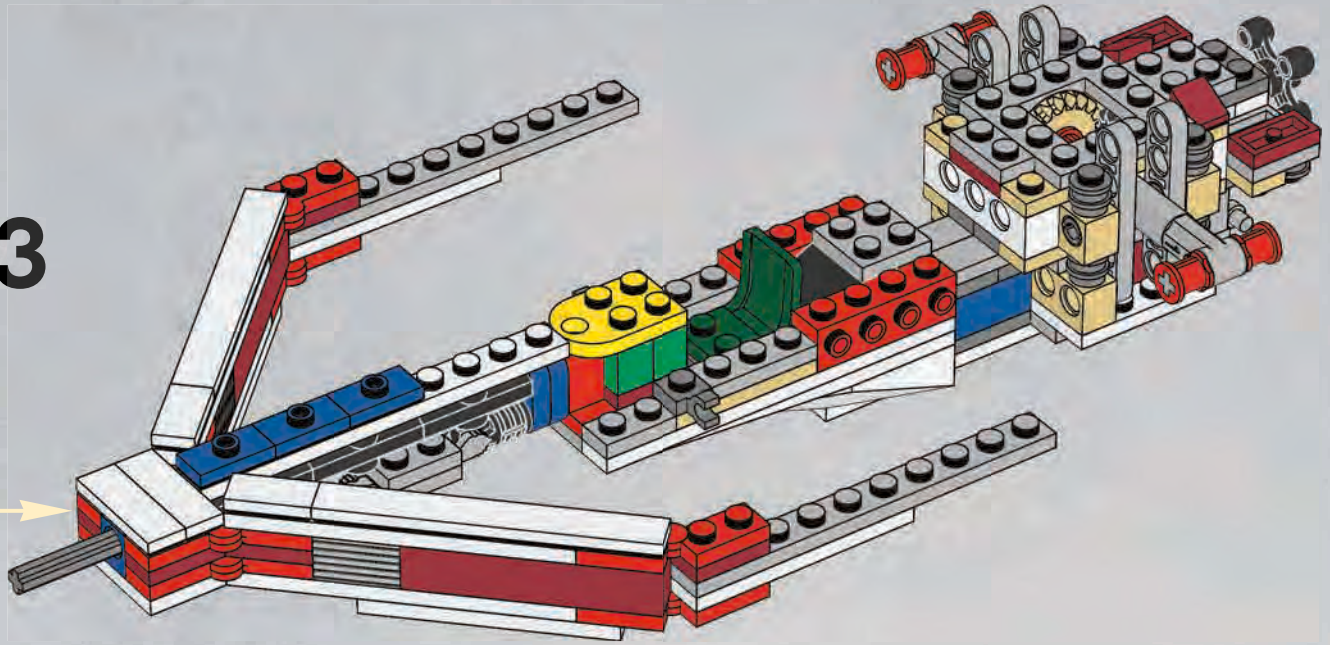

14

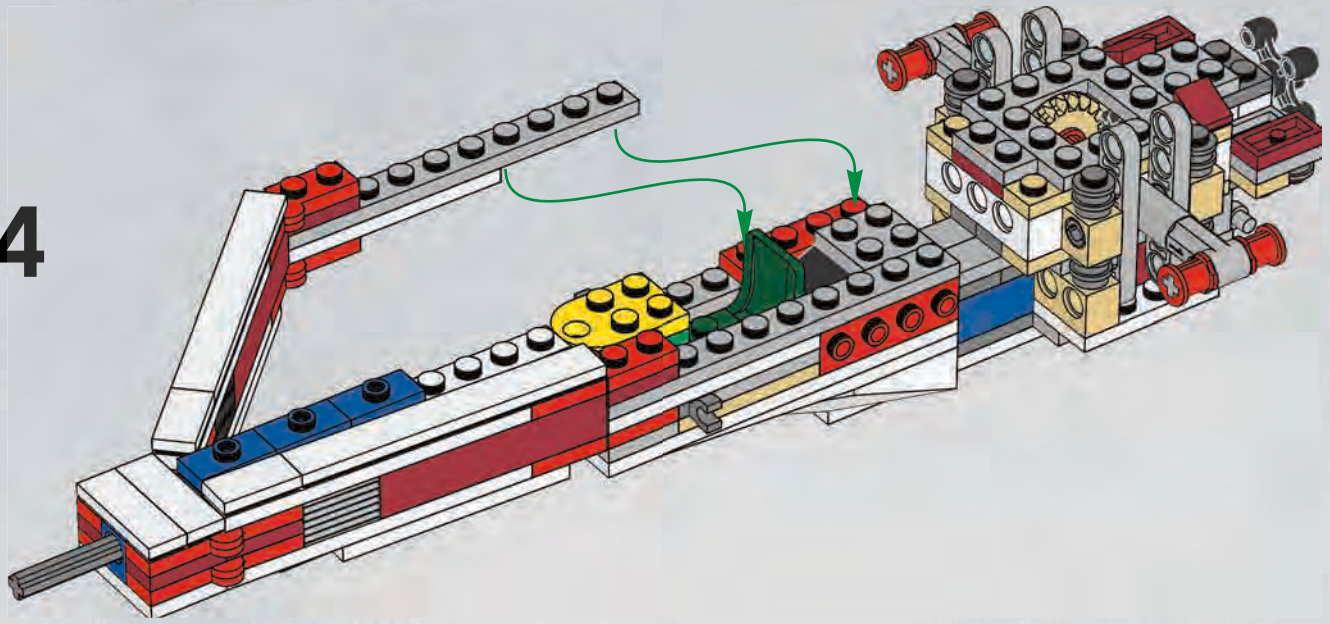



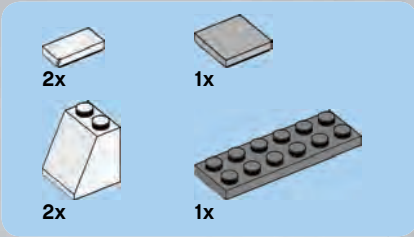

# 15

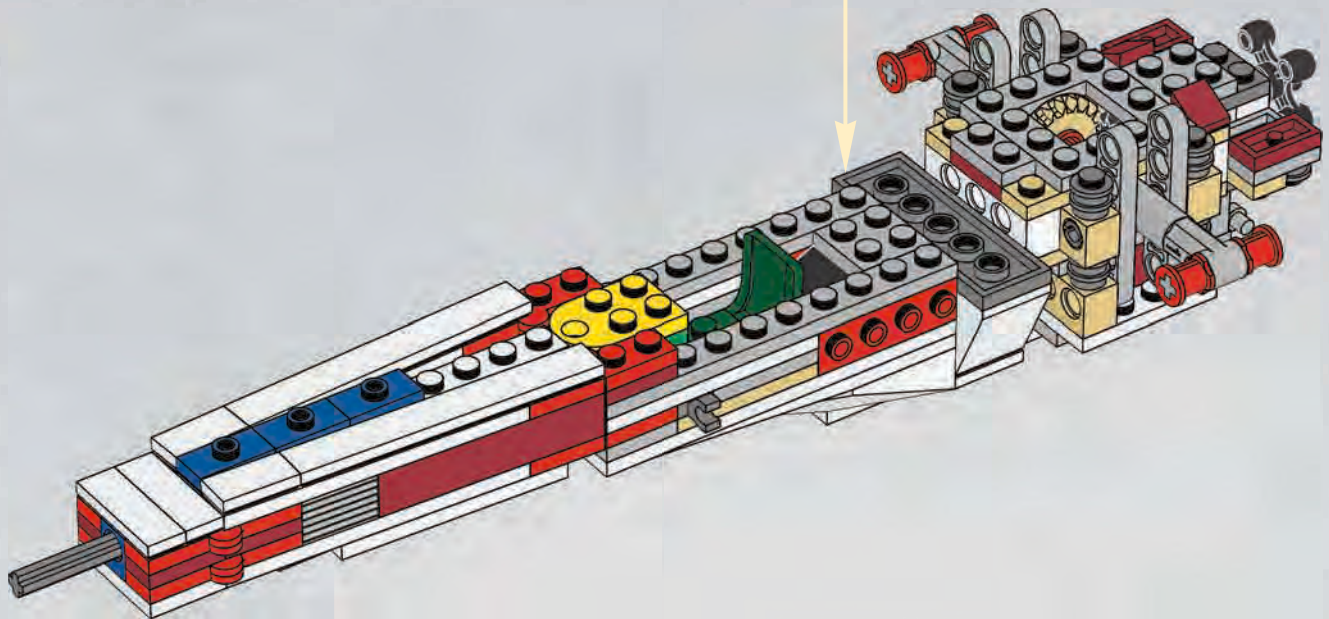
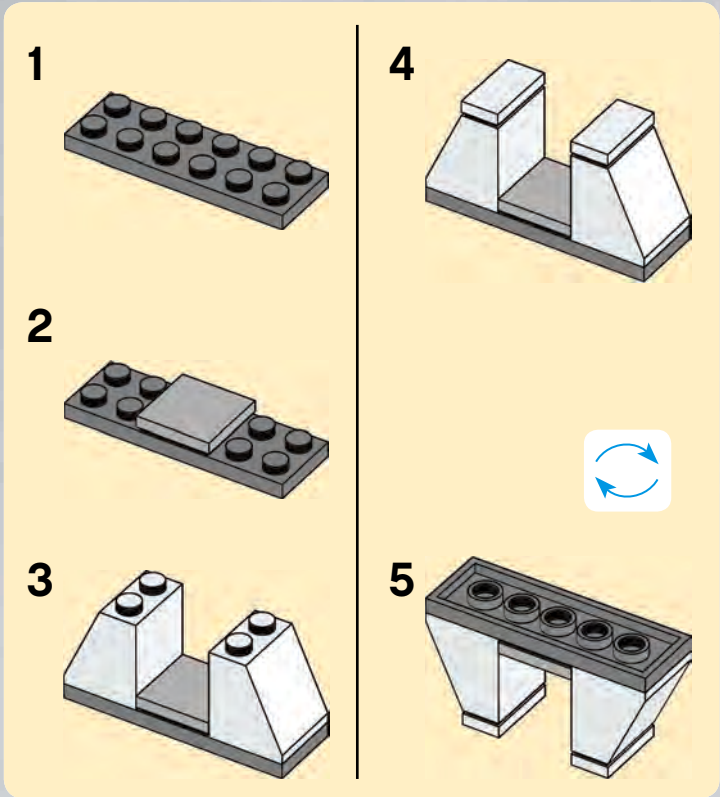





# 16

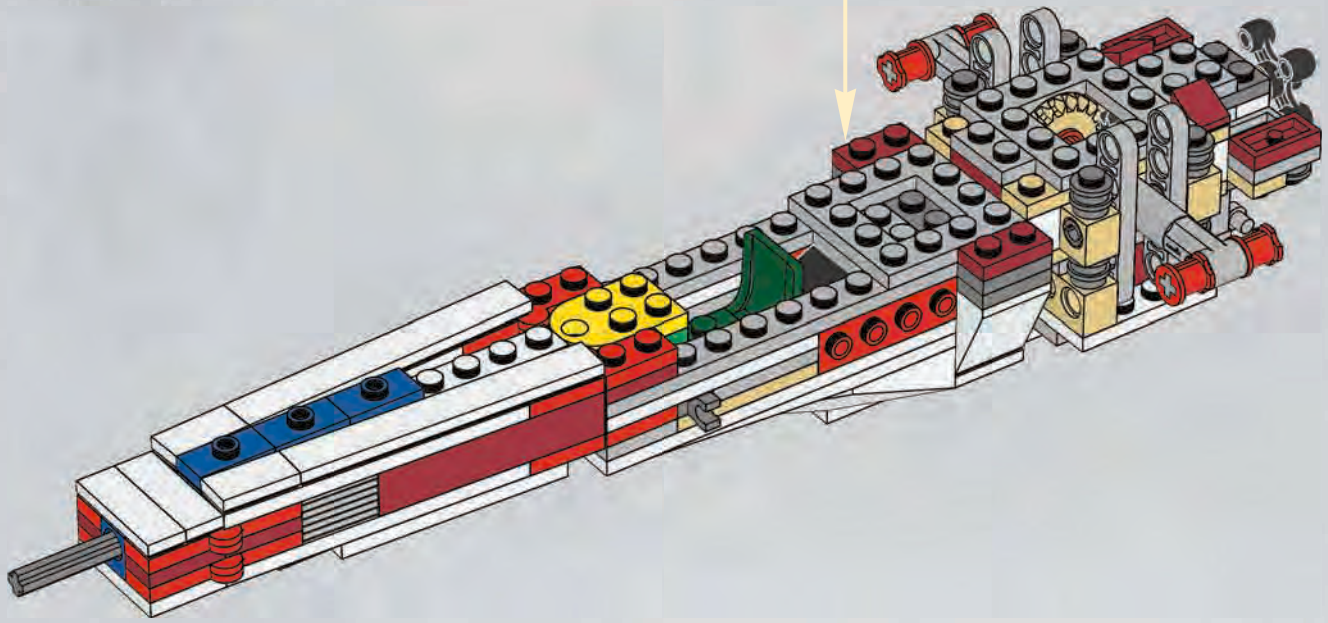
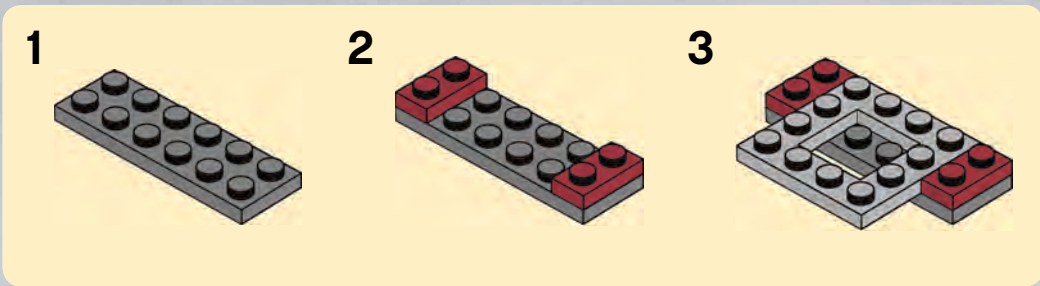



2x



2x

# 17

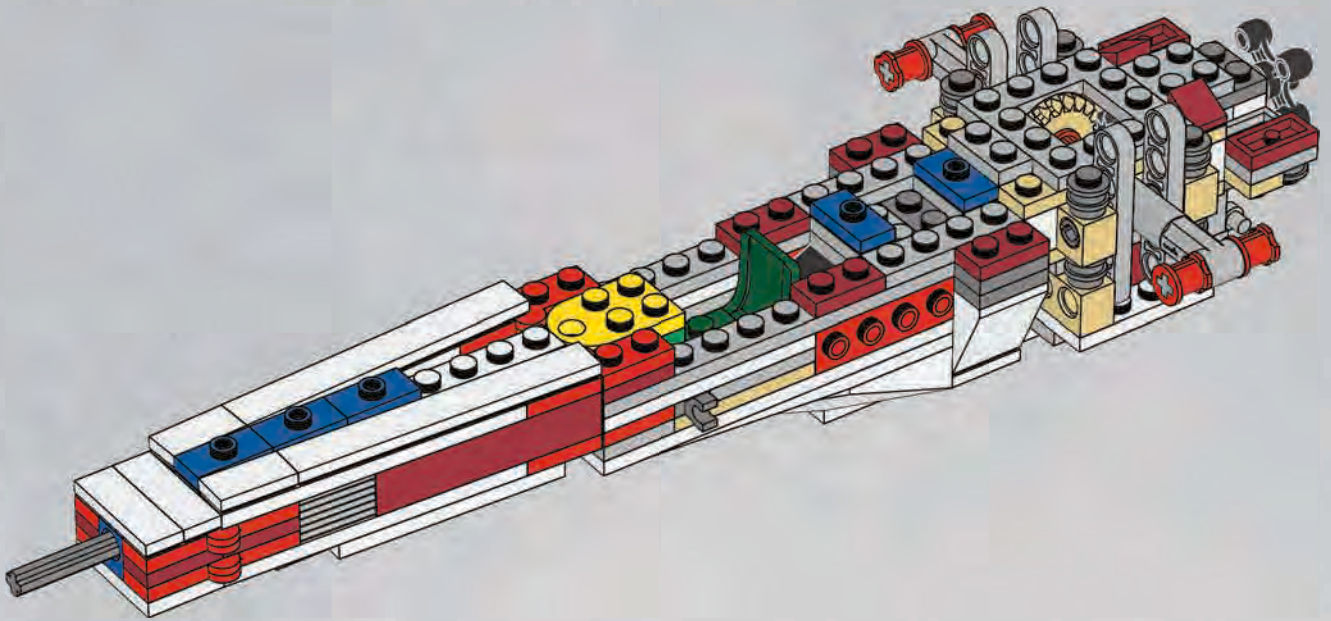

1x



1x



2x

# 18

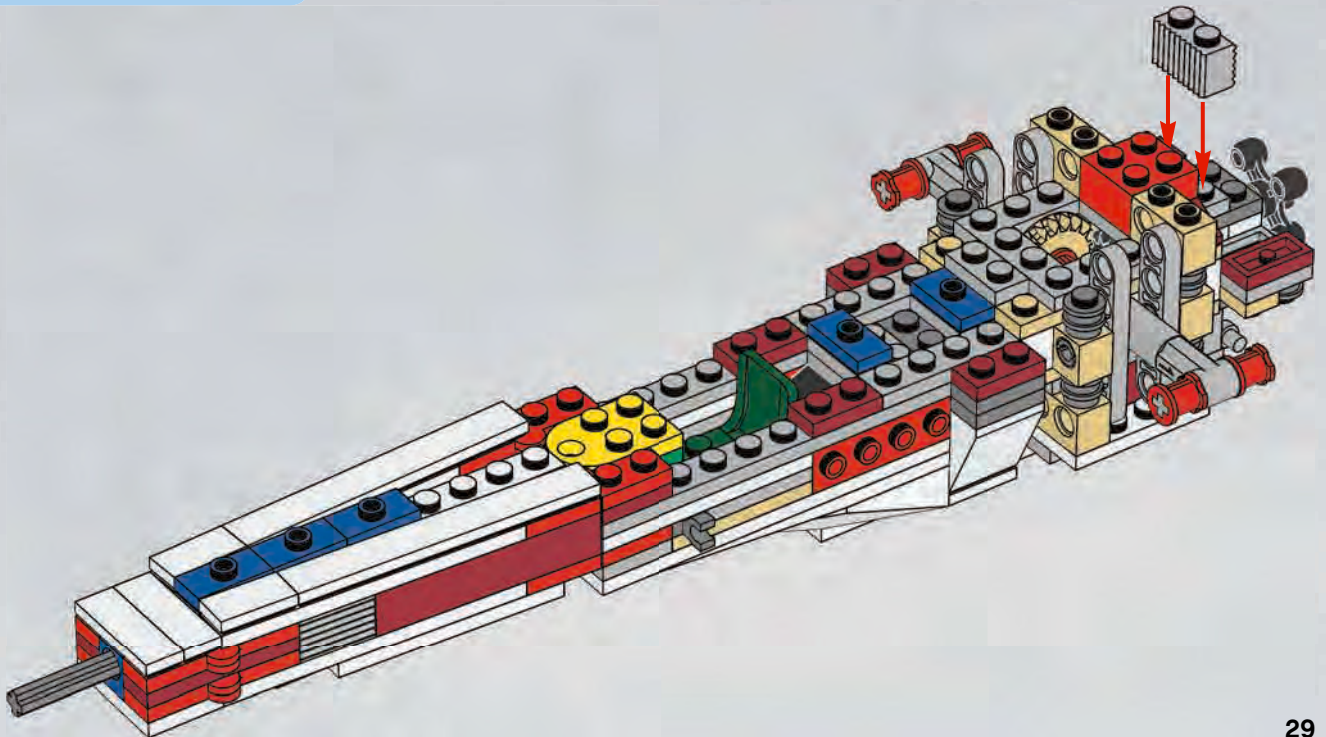



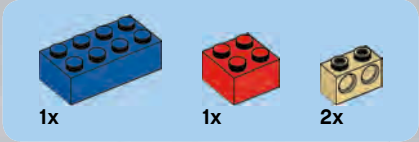

# 19

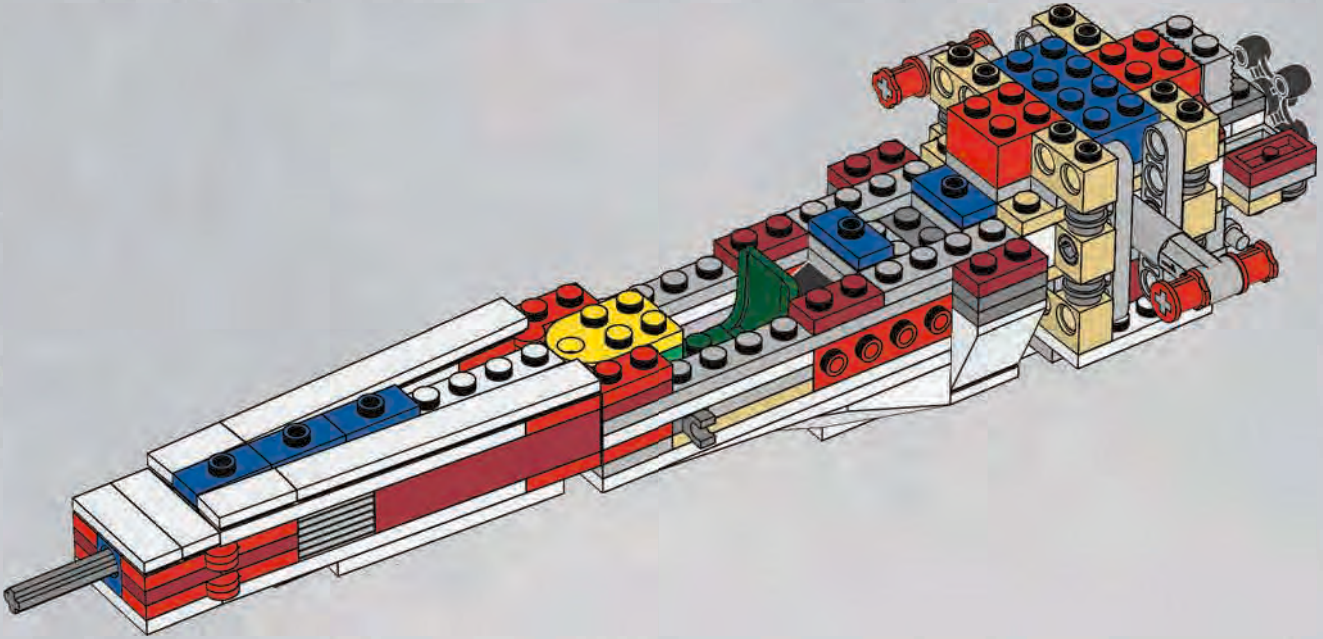

# 20

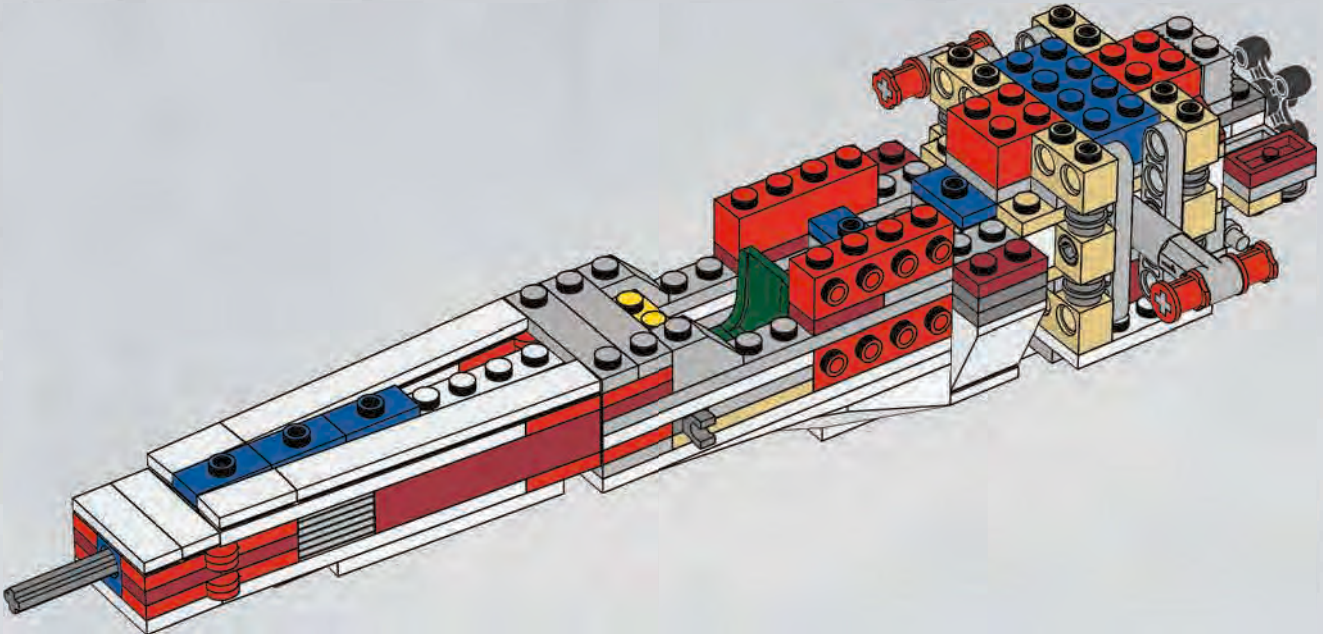





# 21

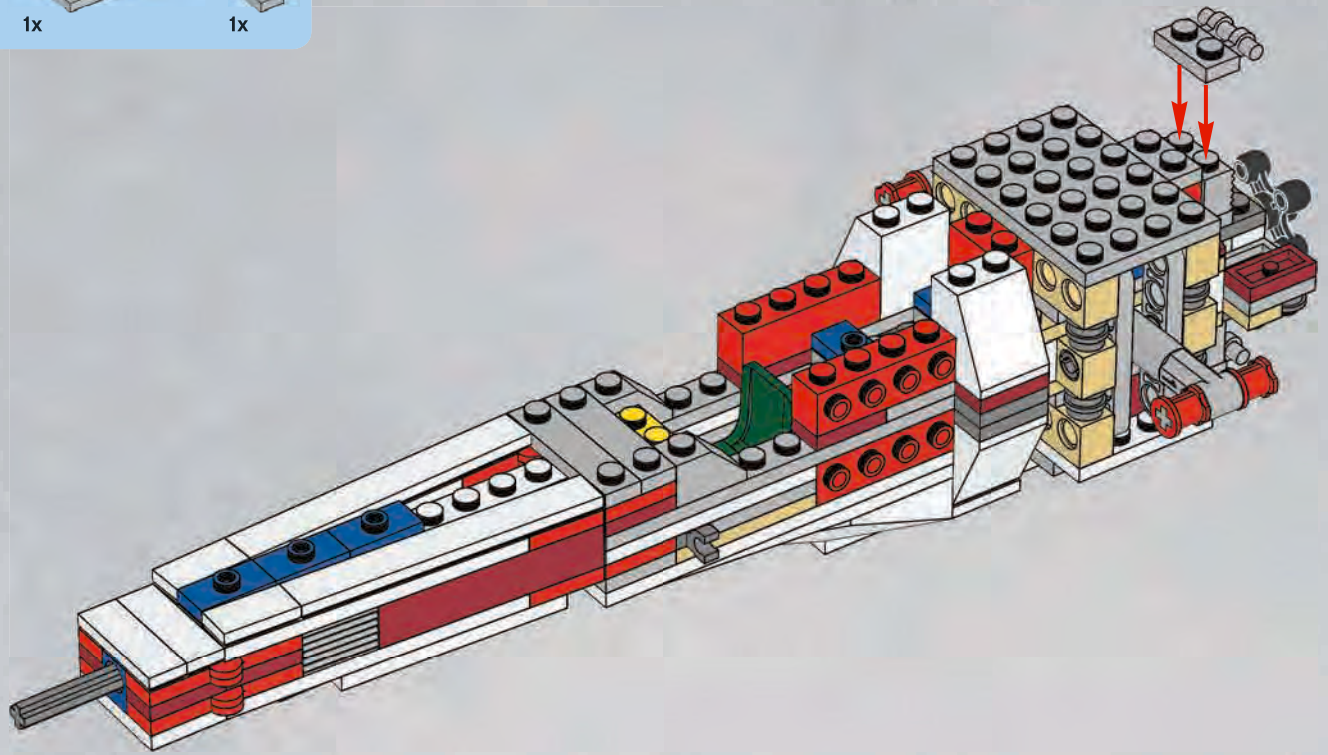

# 22

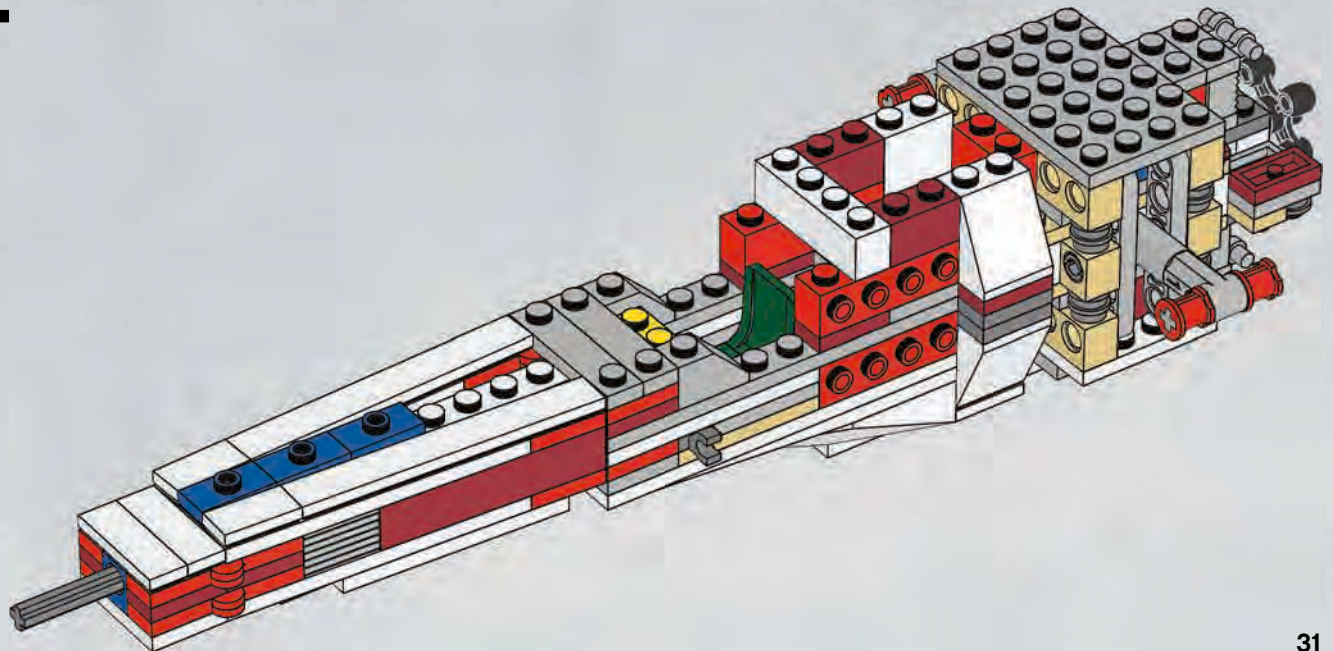

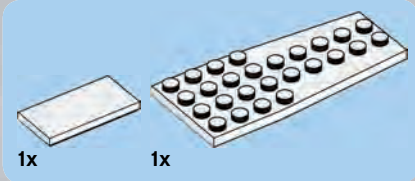

23

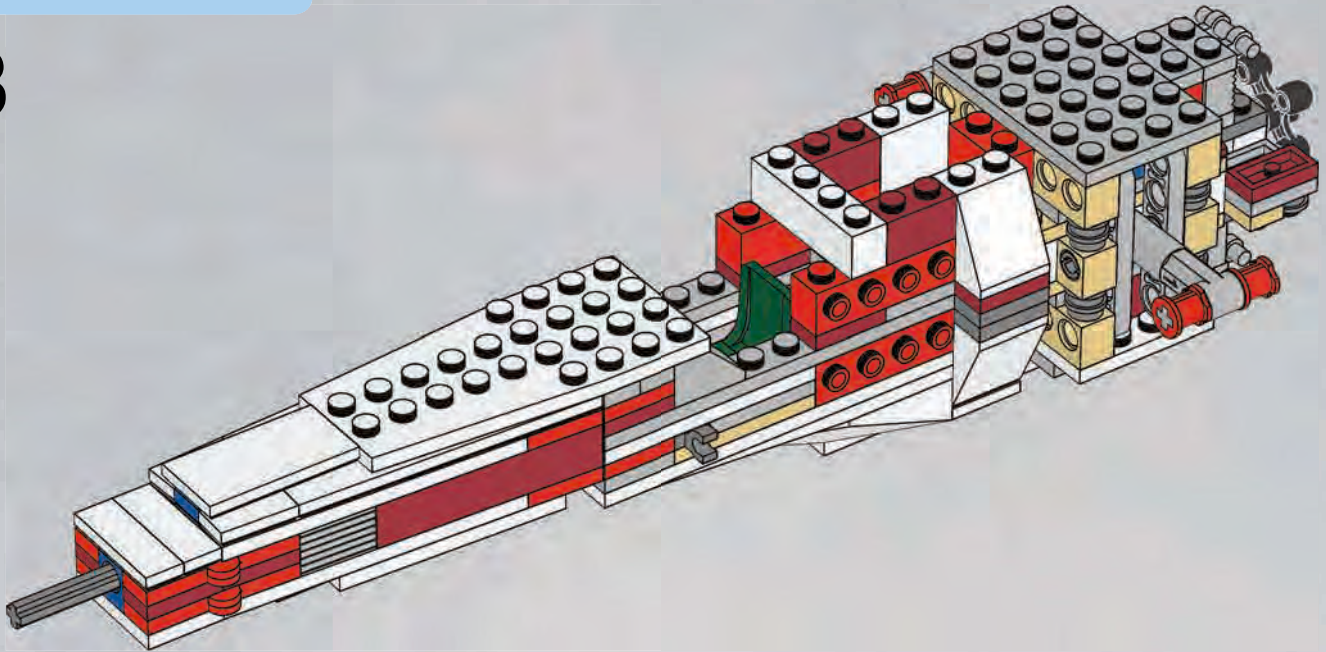

24

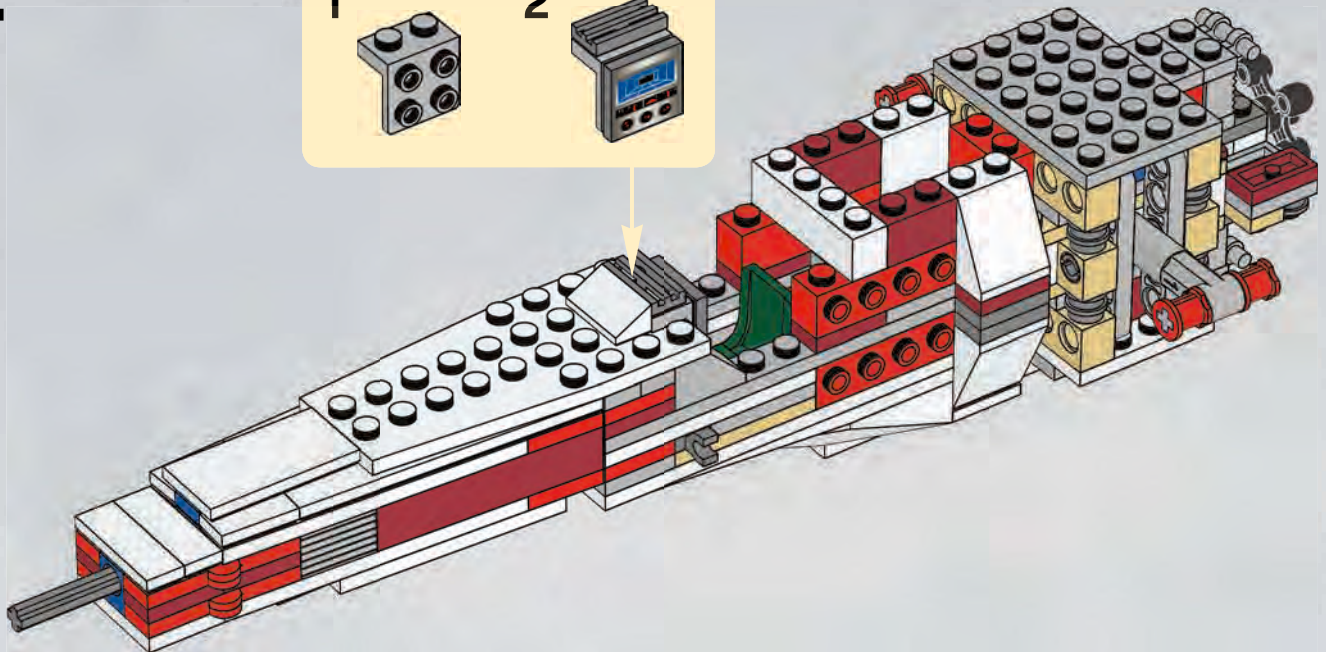
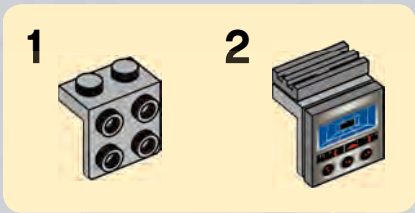





25

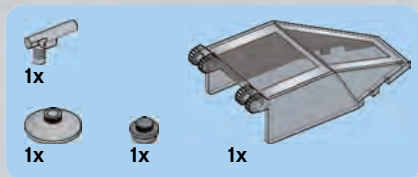
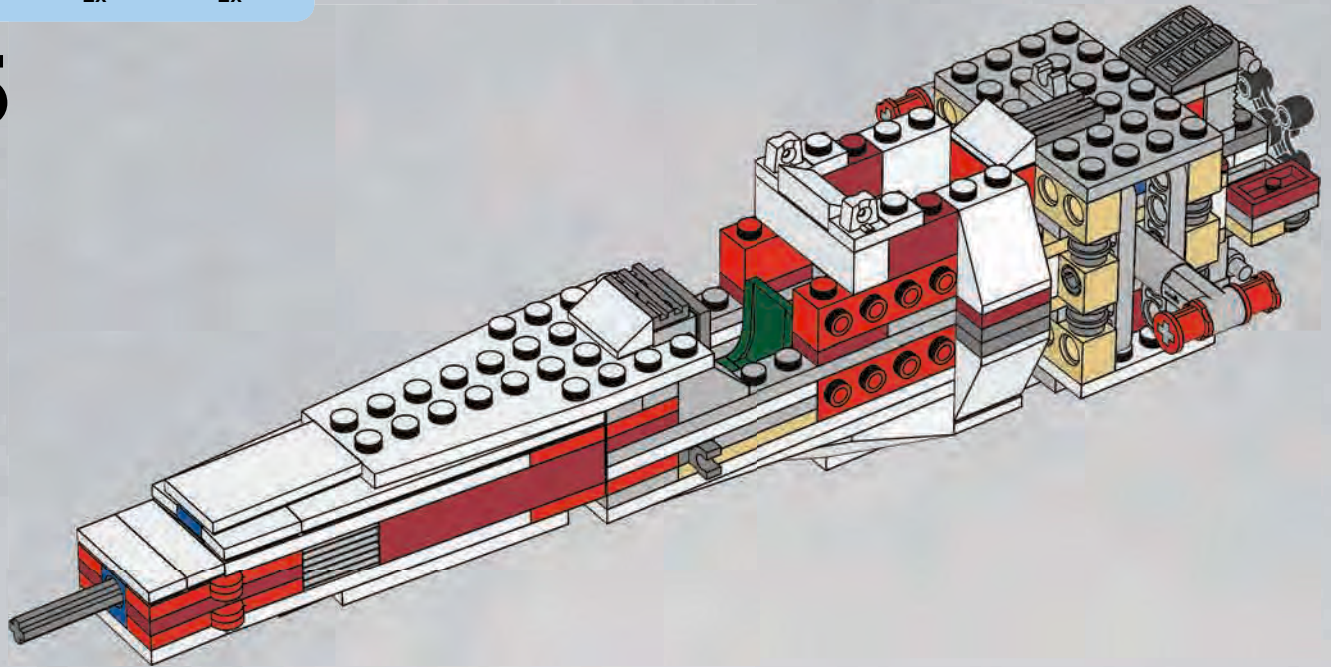

26

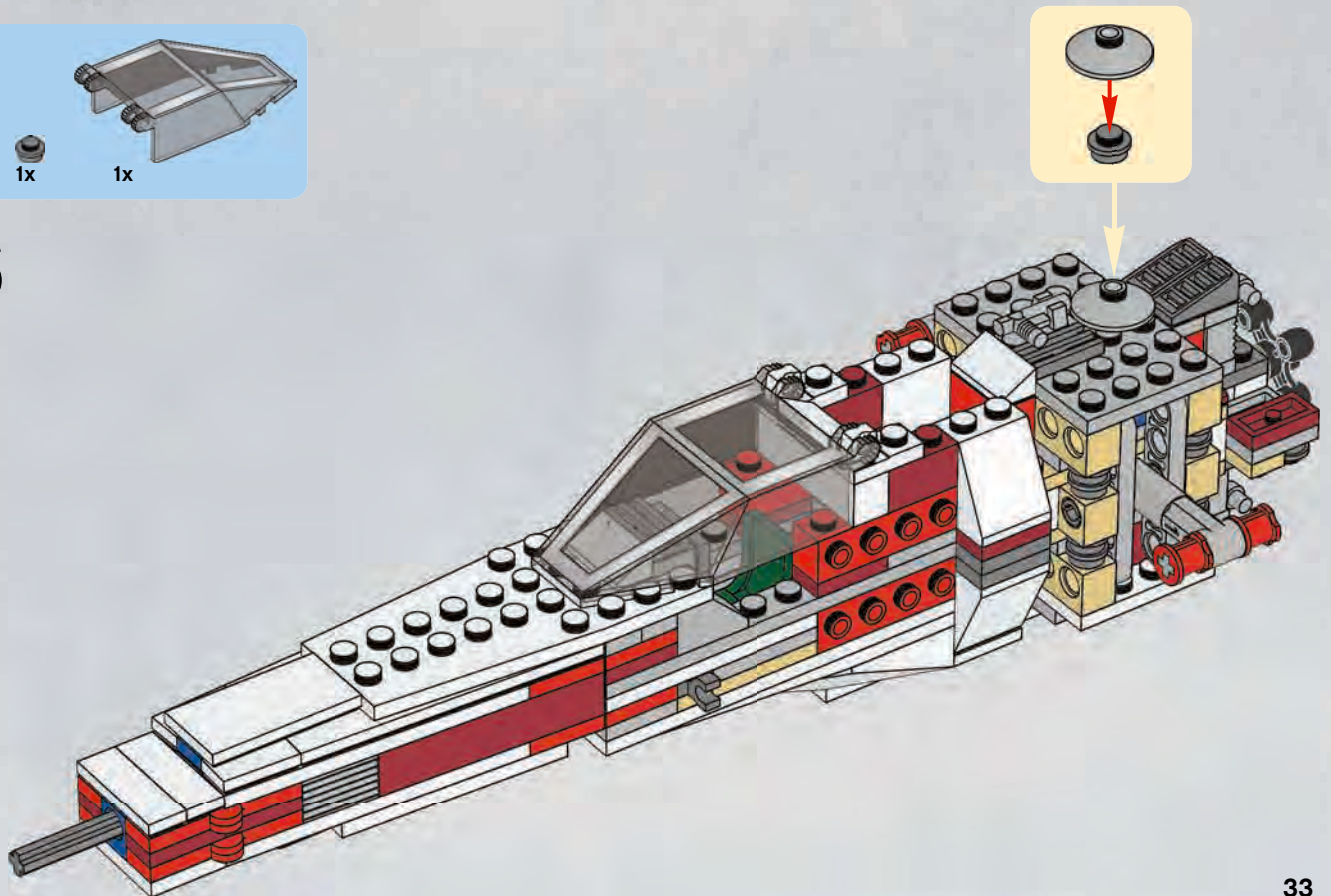



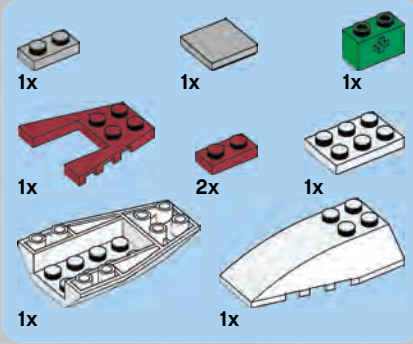

27

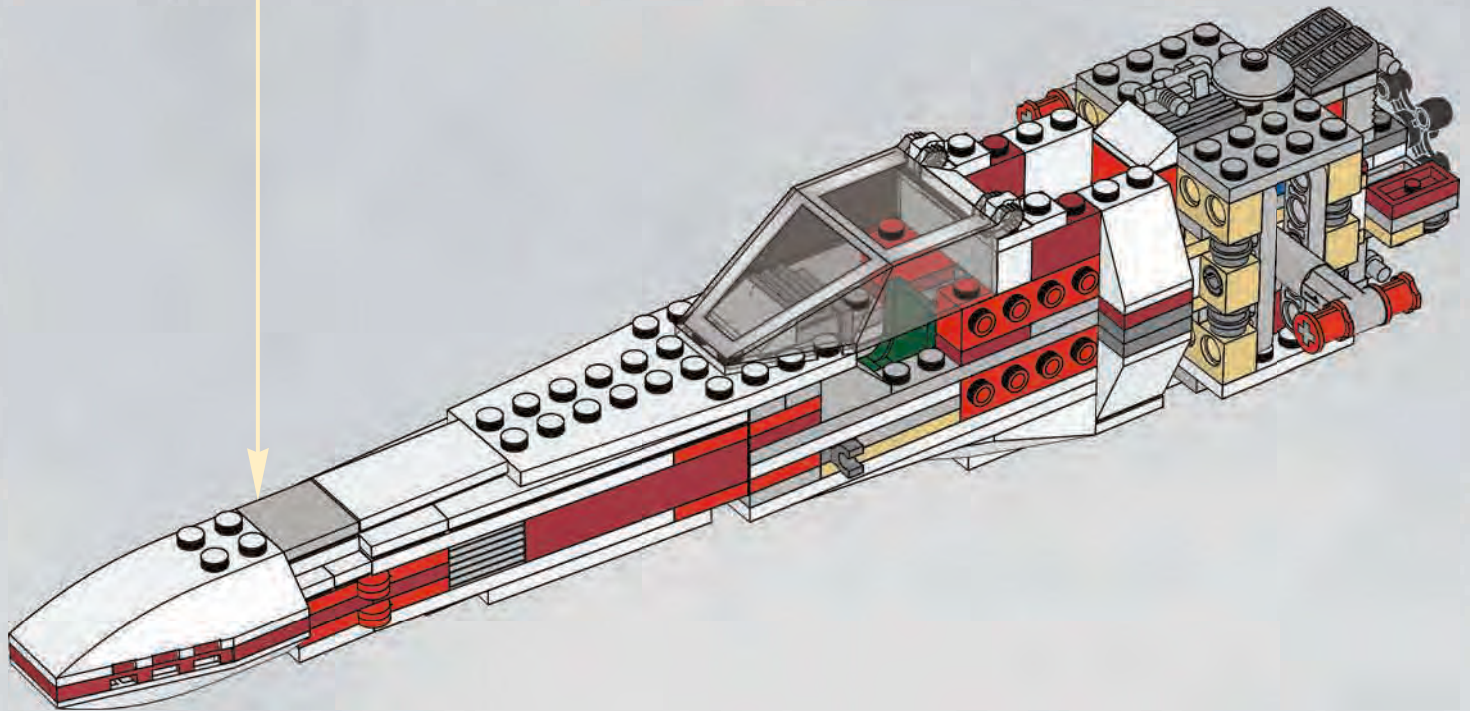
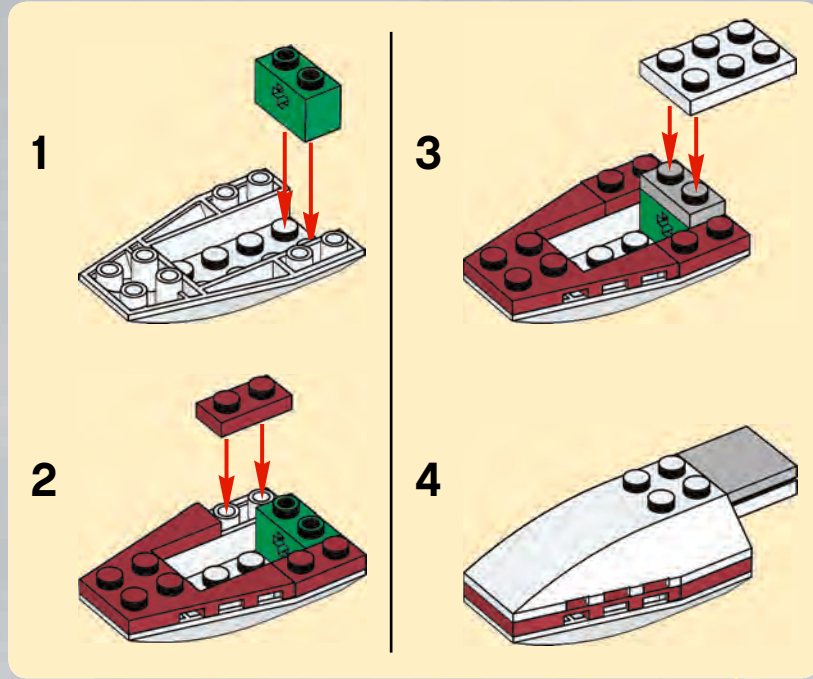

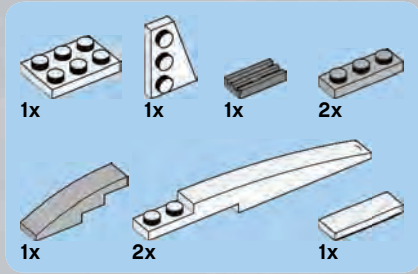

# 28

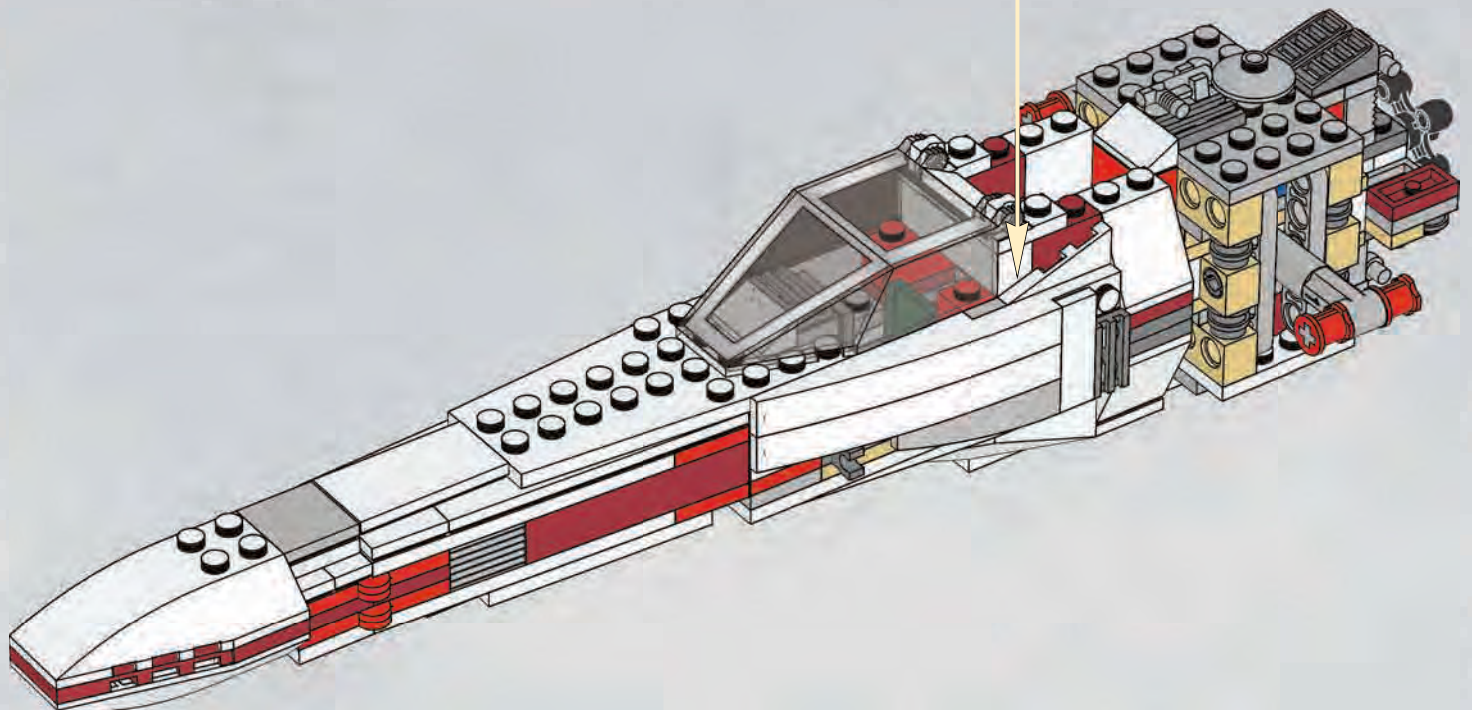
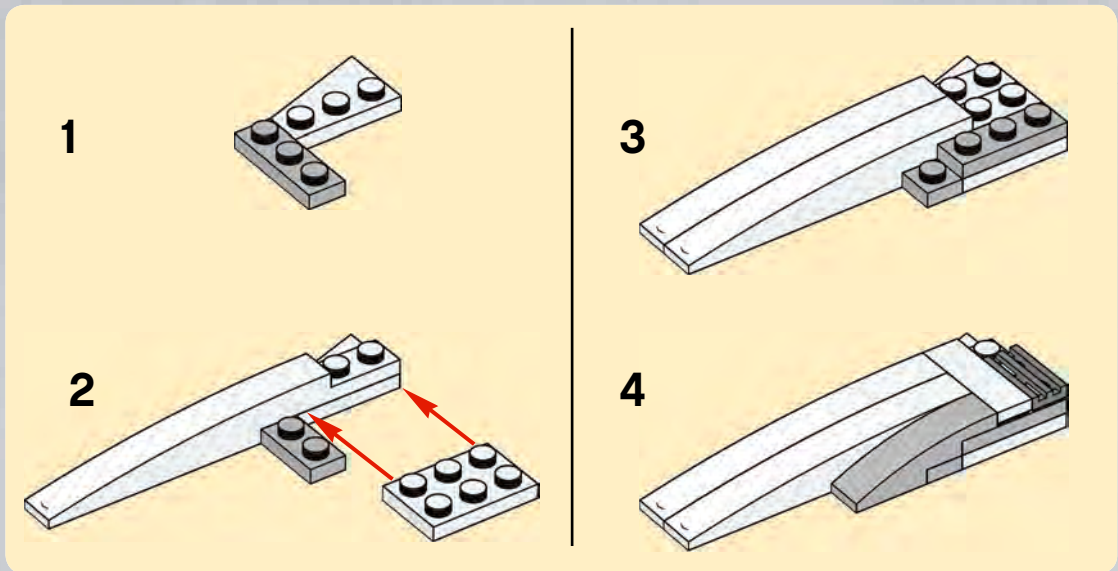



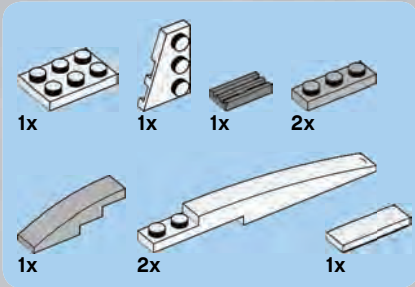

# 29

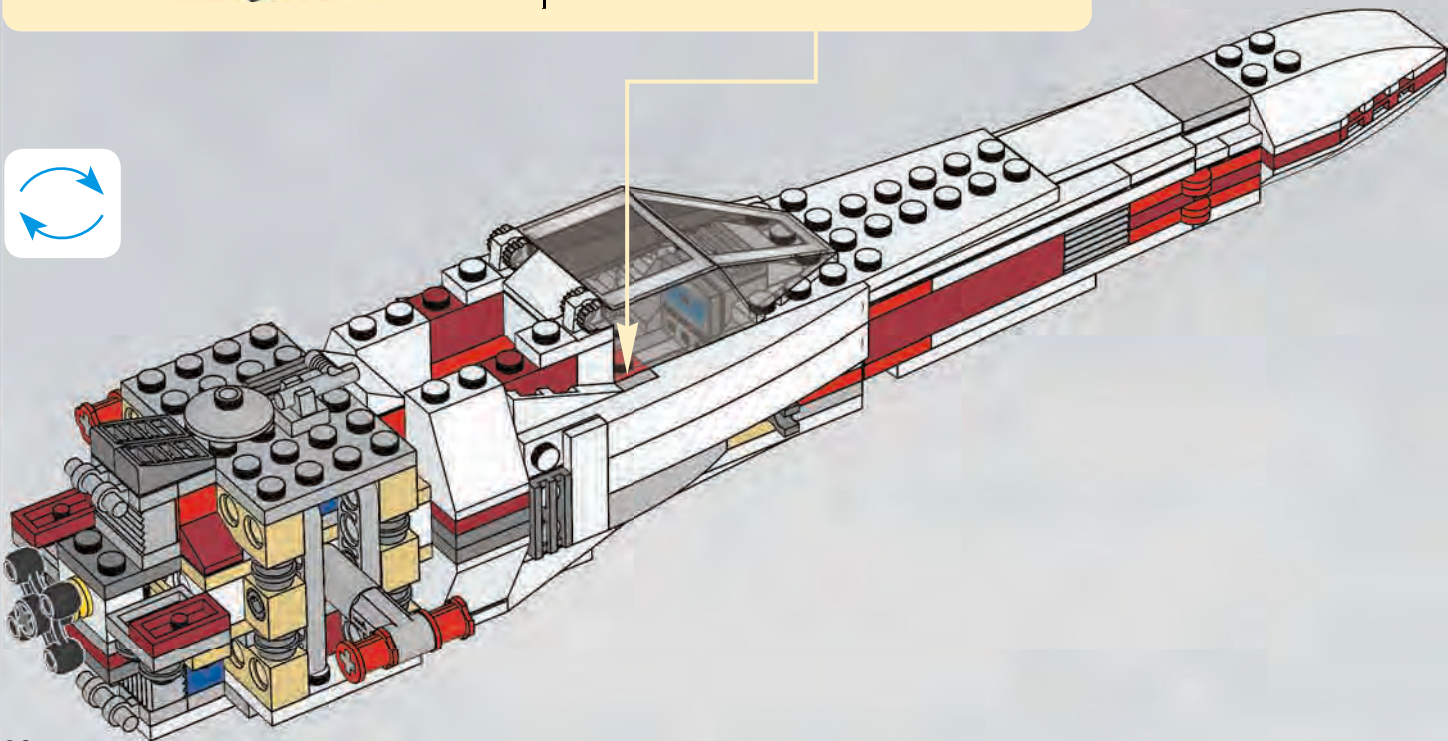
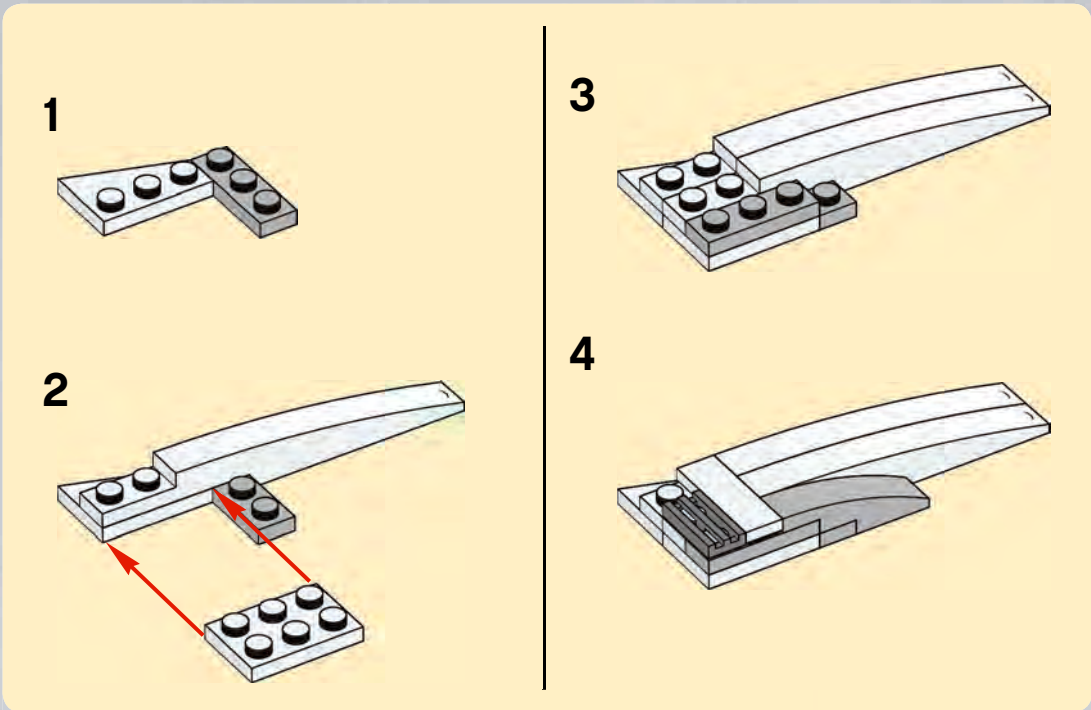



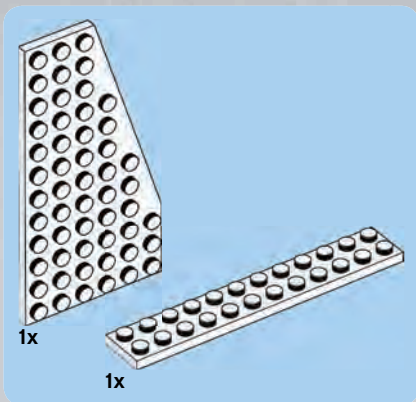
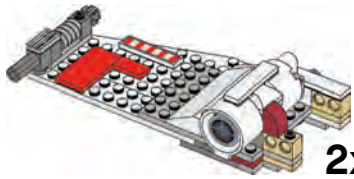
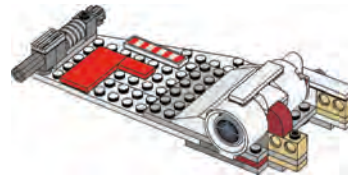
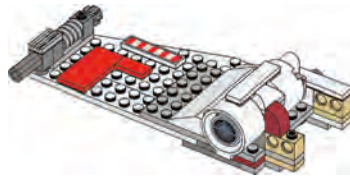

1

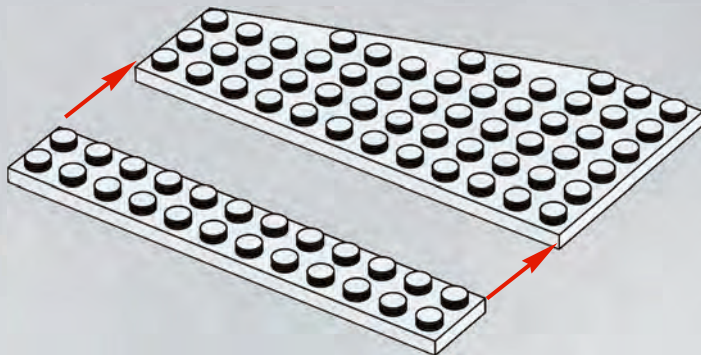

2

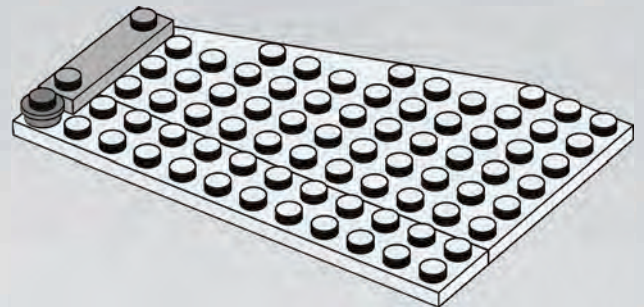
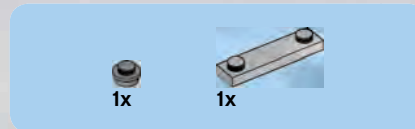



3

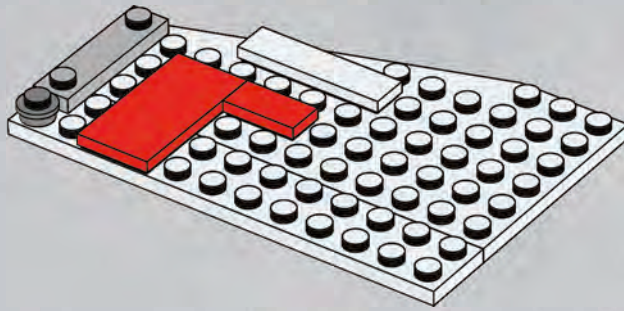

4

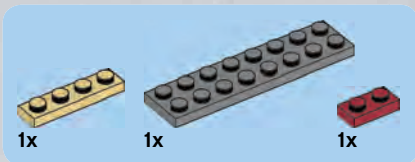
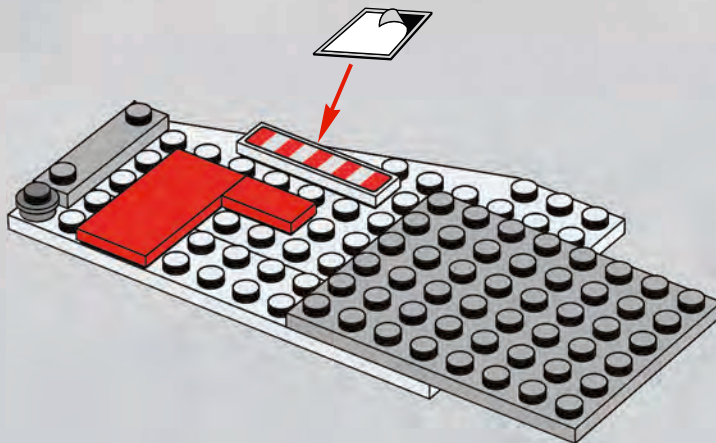

5

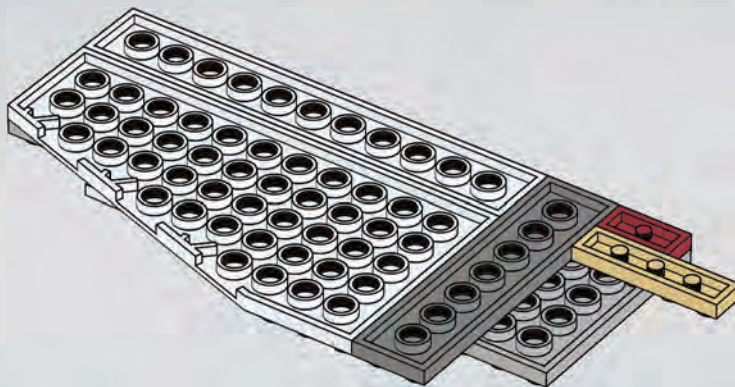



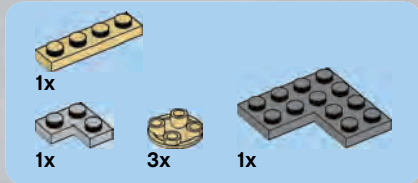

6

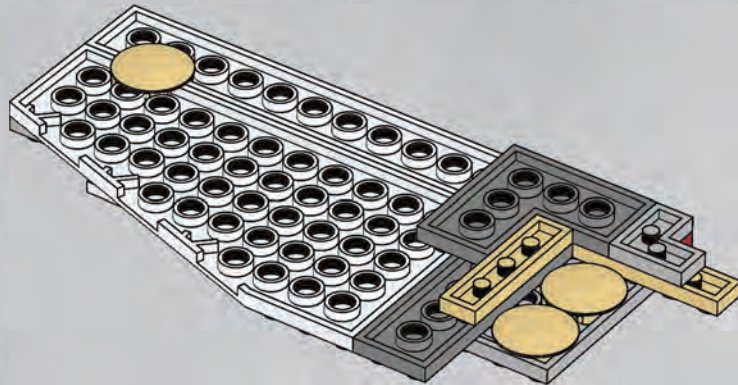

7

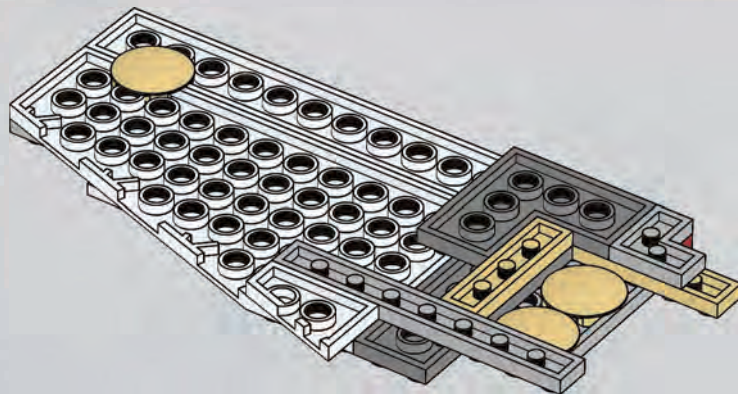

8

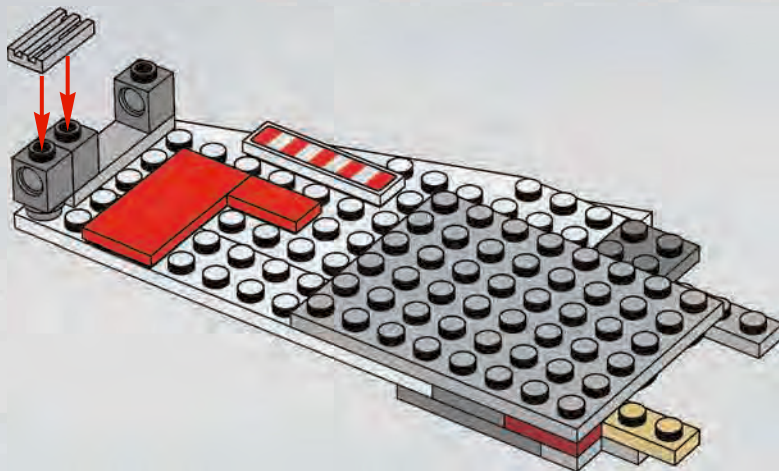



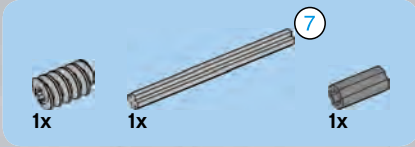

9

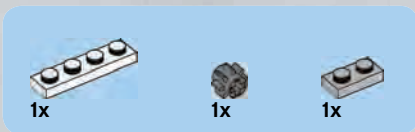
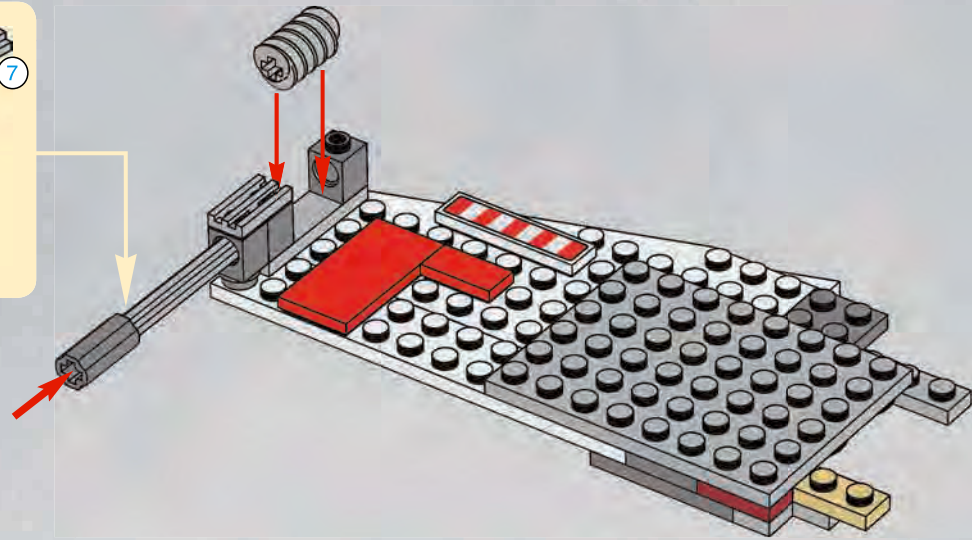
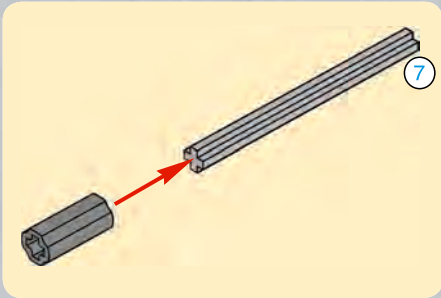

10

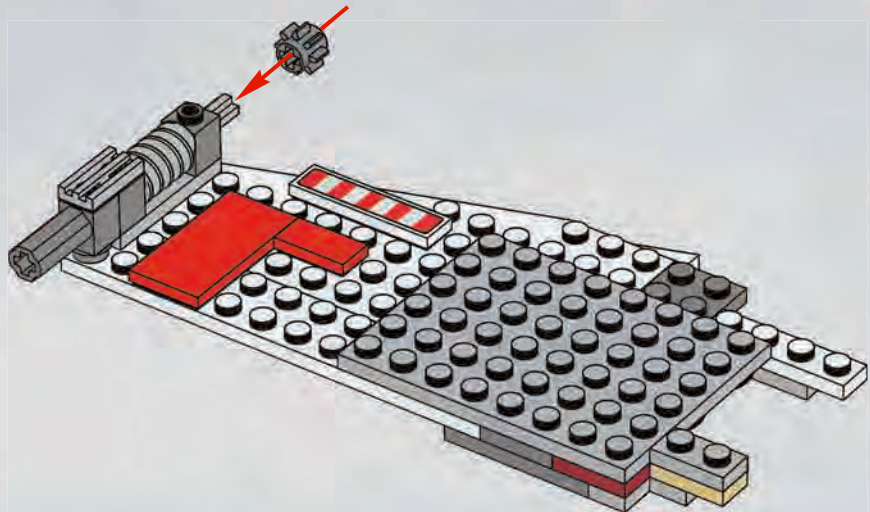

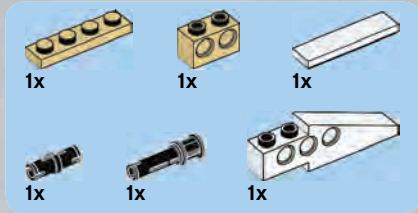

# 11

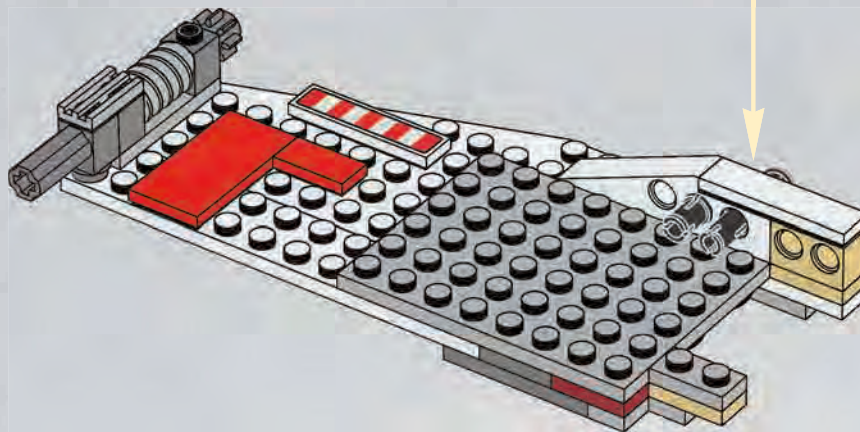
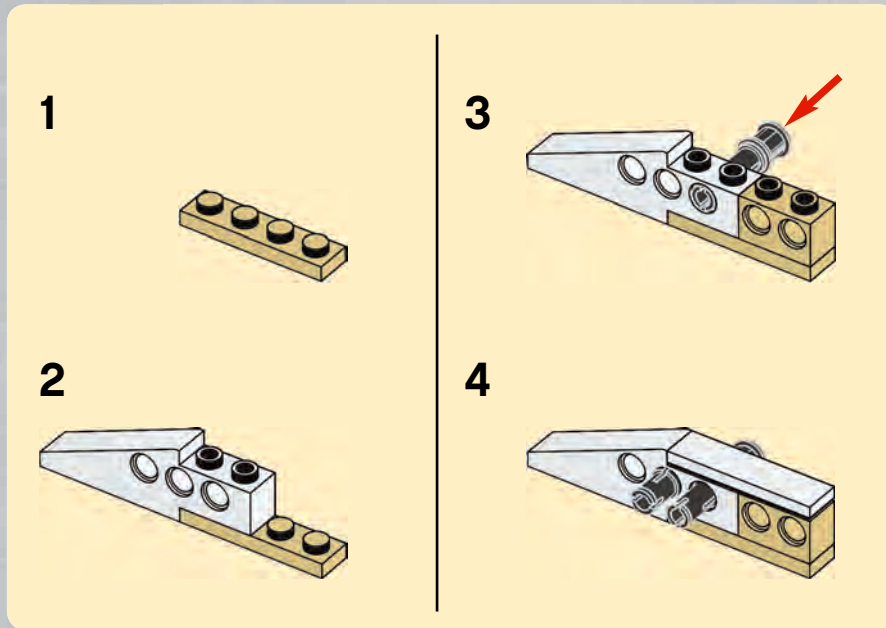



# 12

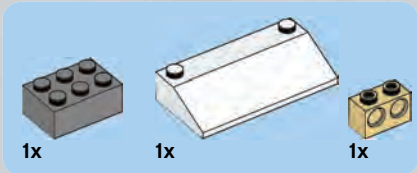
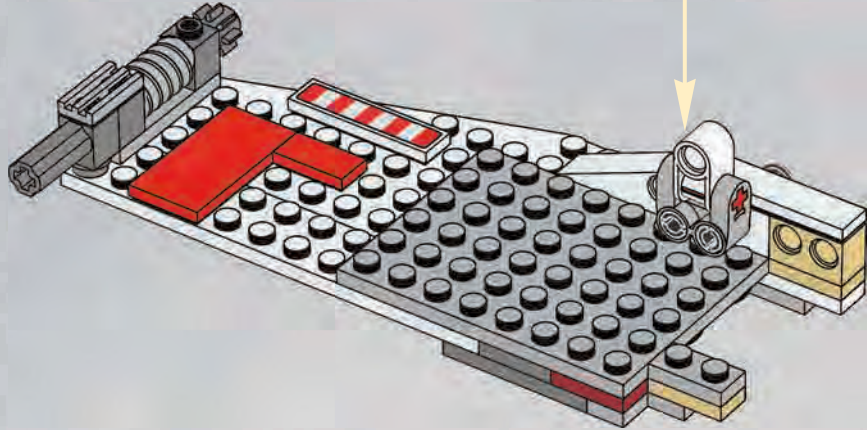
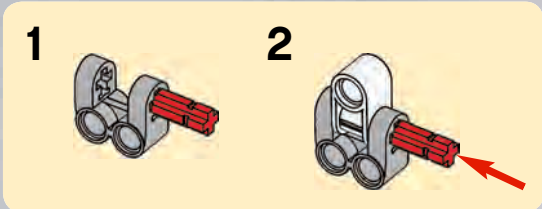

# 13

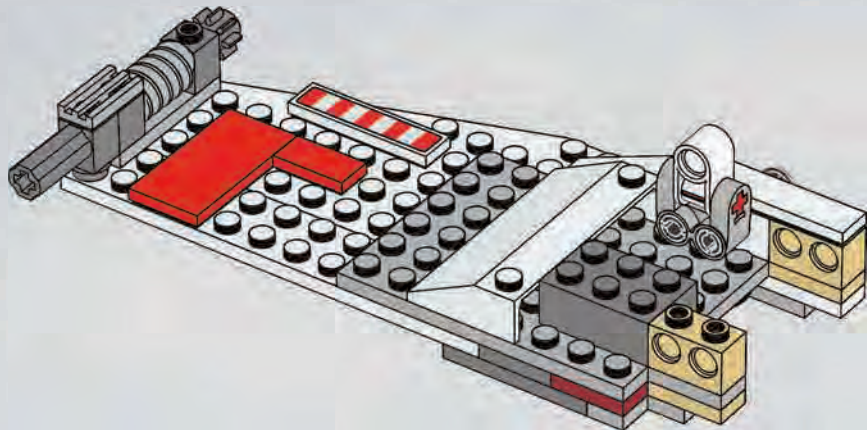



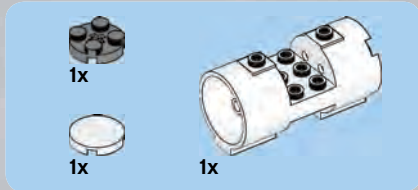

# 14

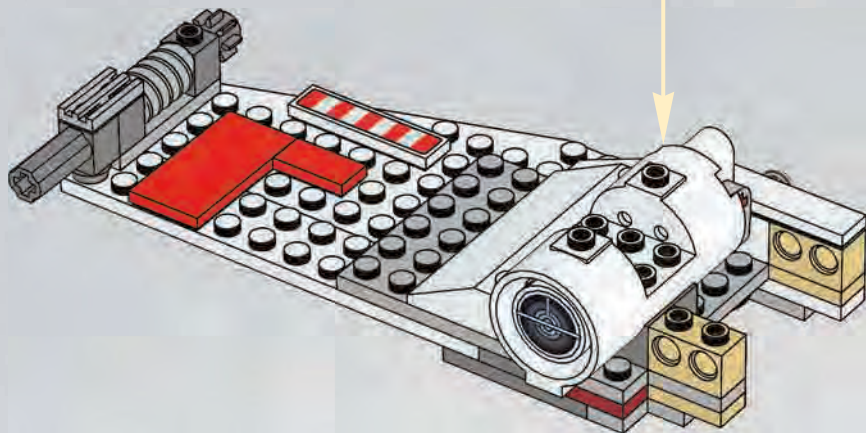
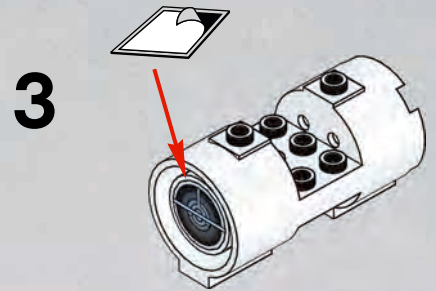
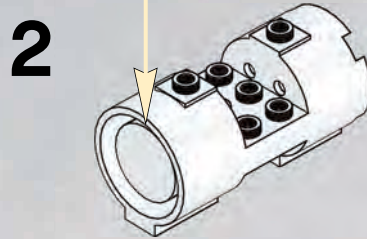
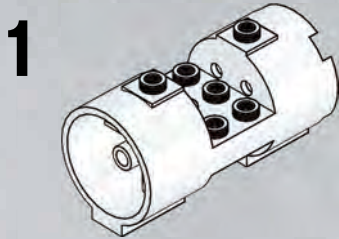



1x



1x



1x

# 15

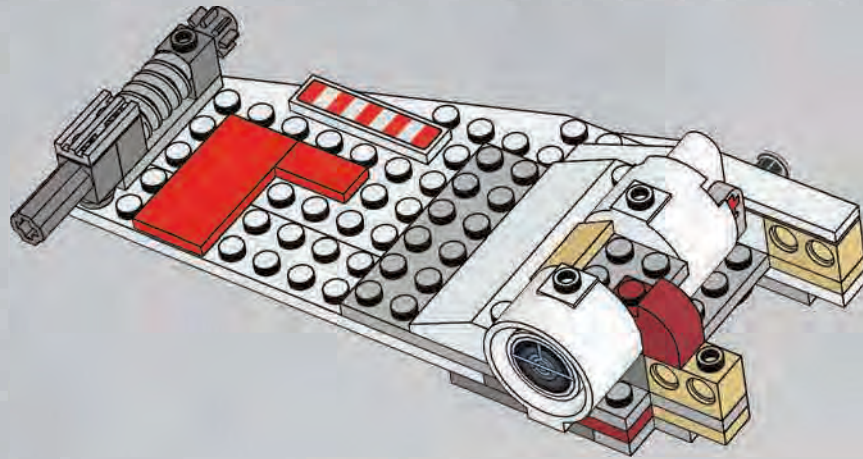

1x

# 16

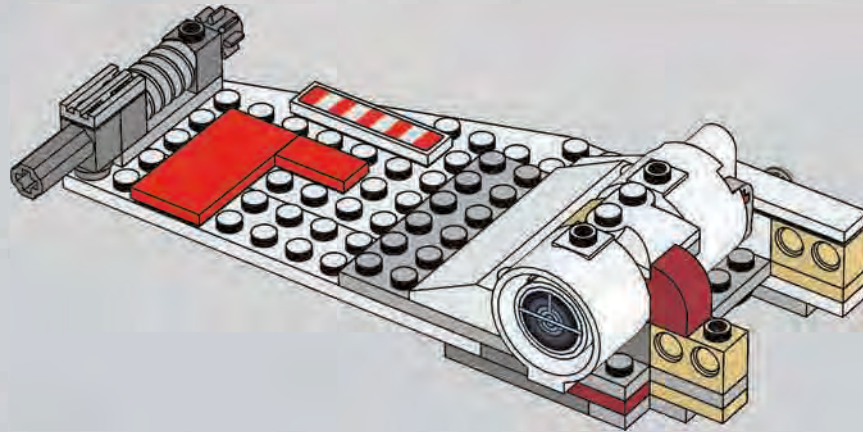

1x

# 17

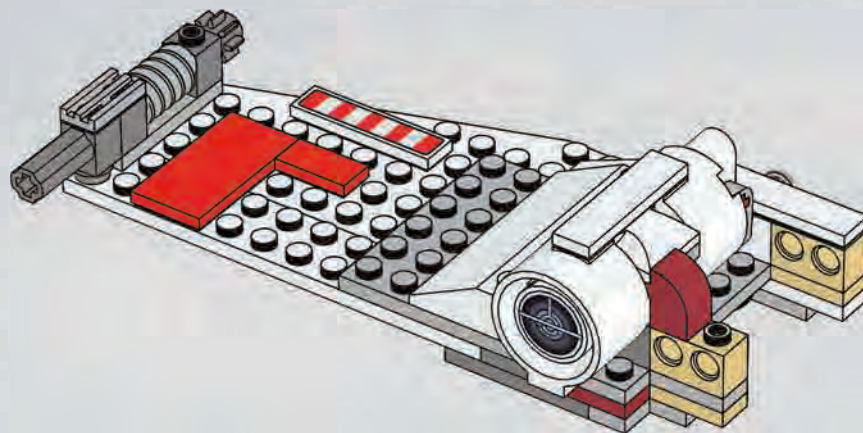

# 2x



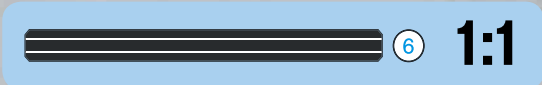
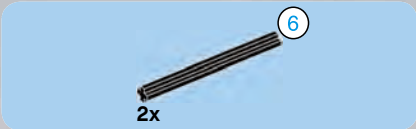

18

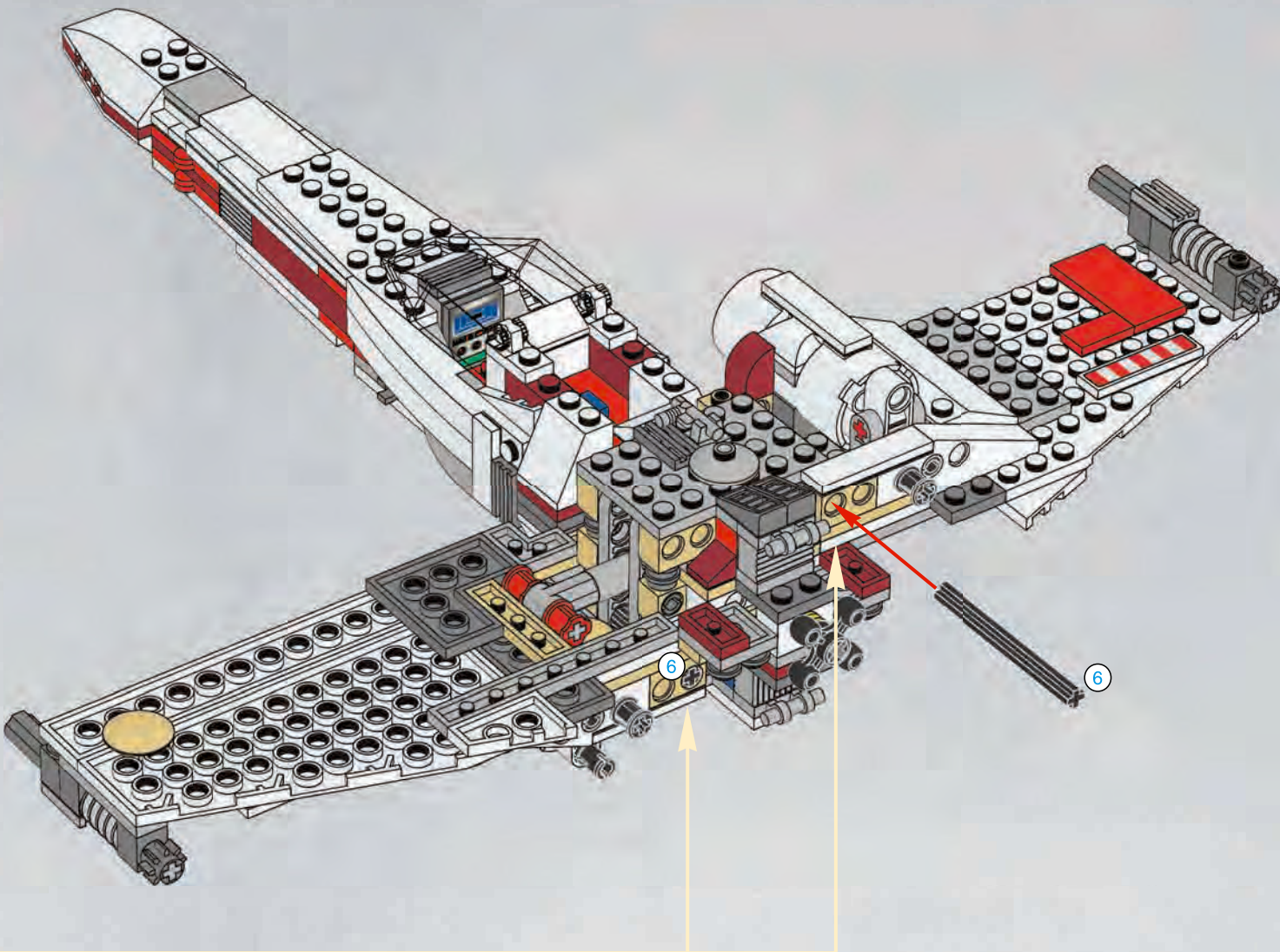





4

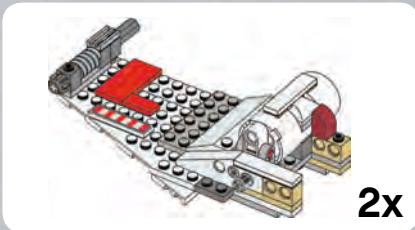
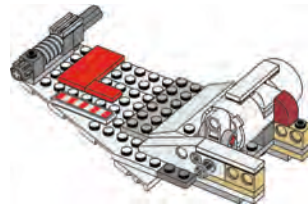
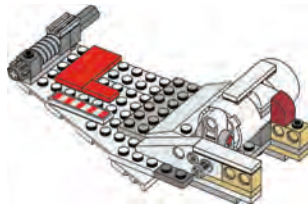

2x

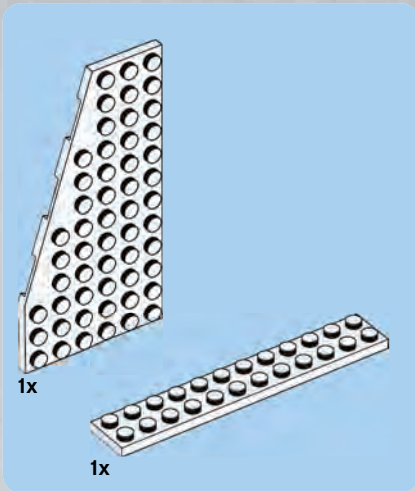

1x

1x

1

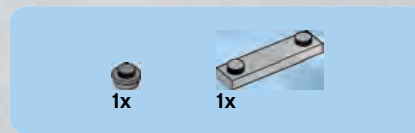
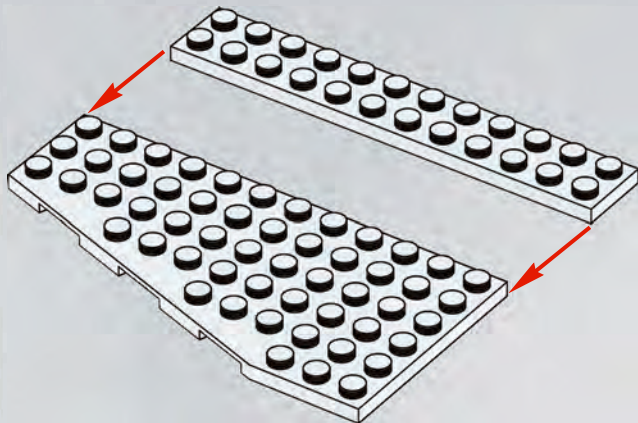

1x

1x

2

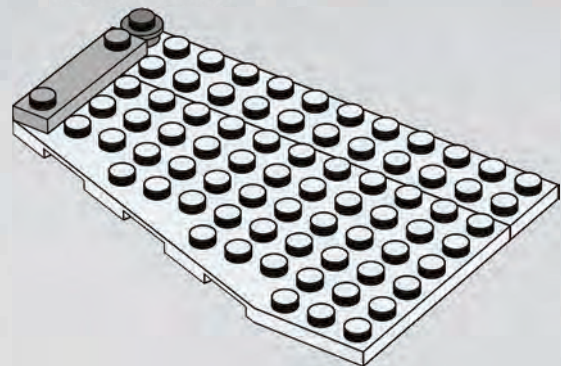

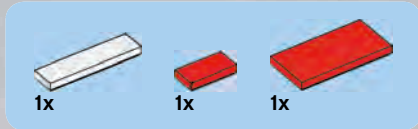

3

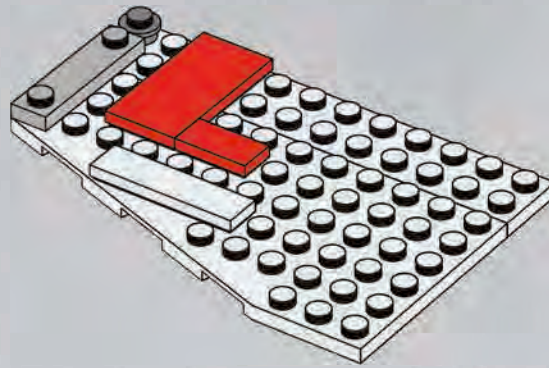

4

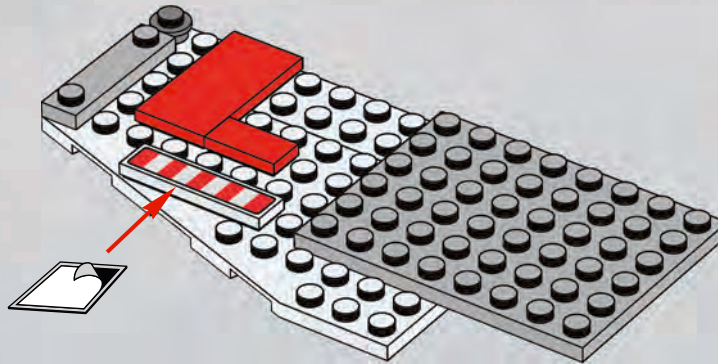

5

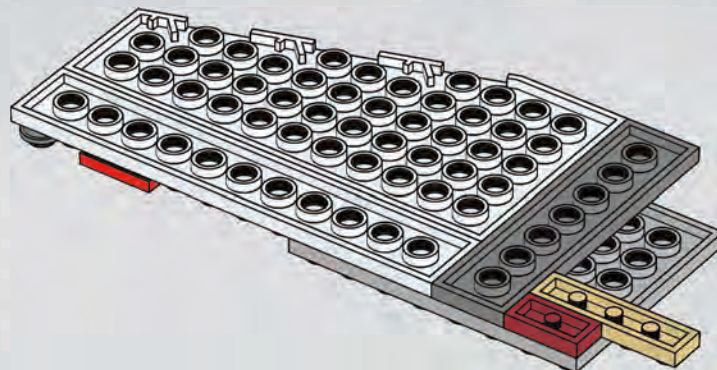



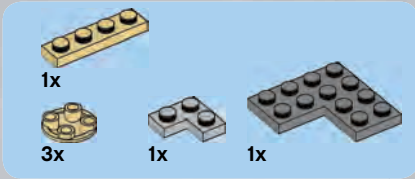

6

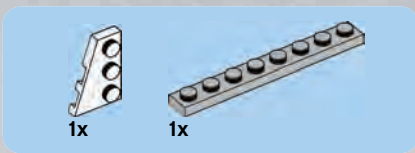
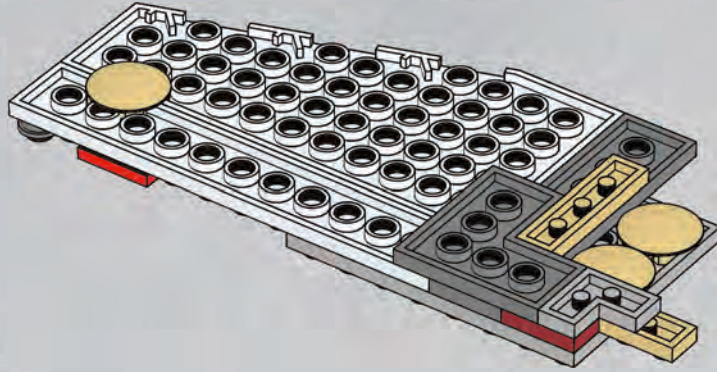

7

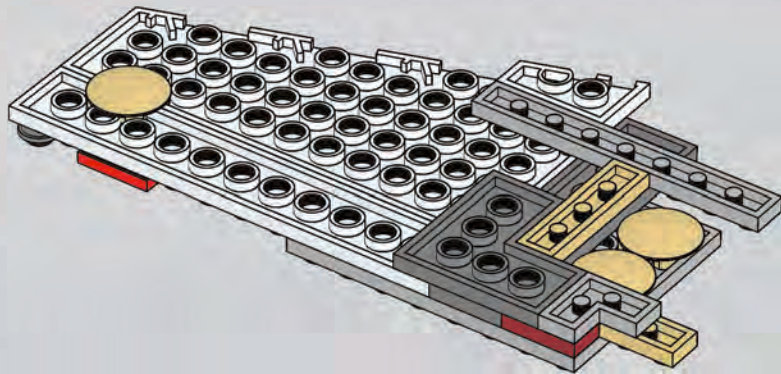

8

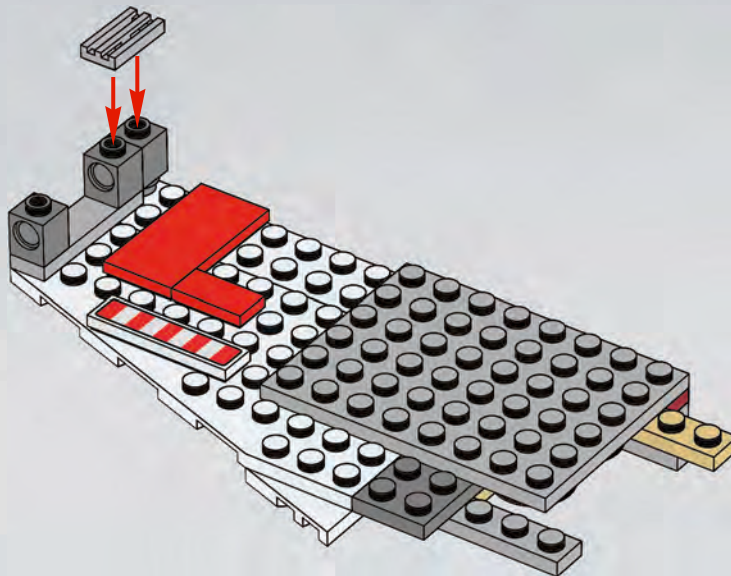

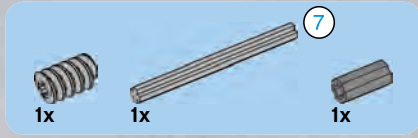

9

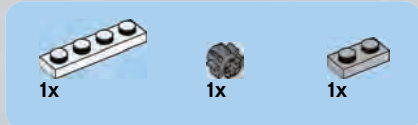
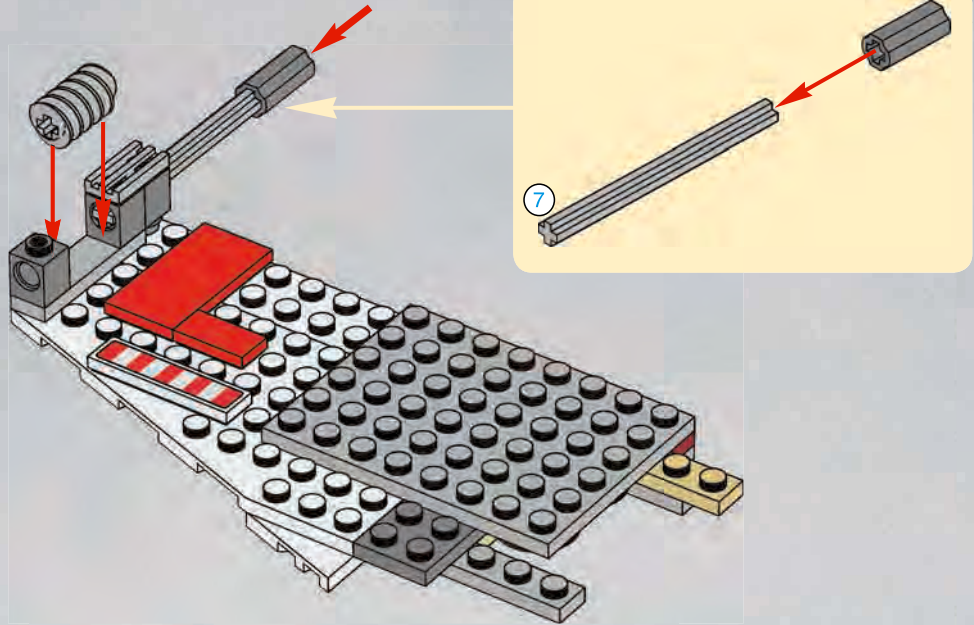

10

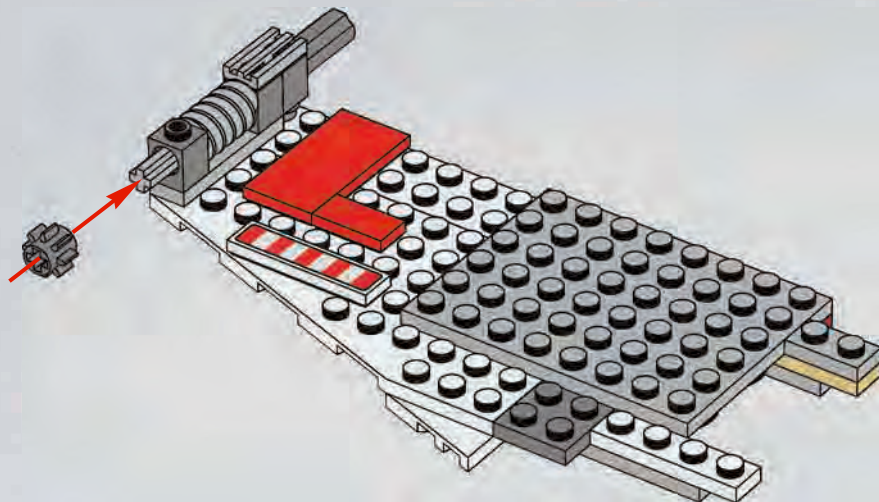

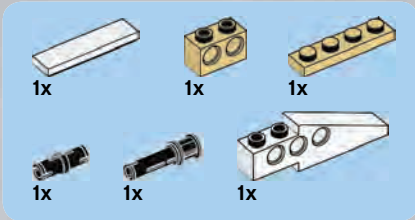

# 11

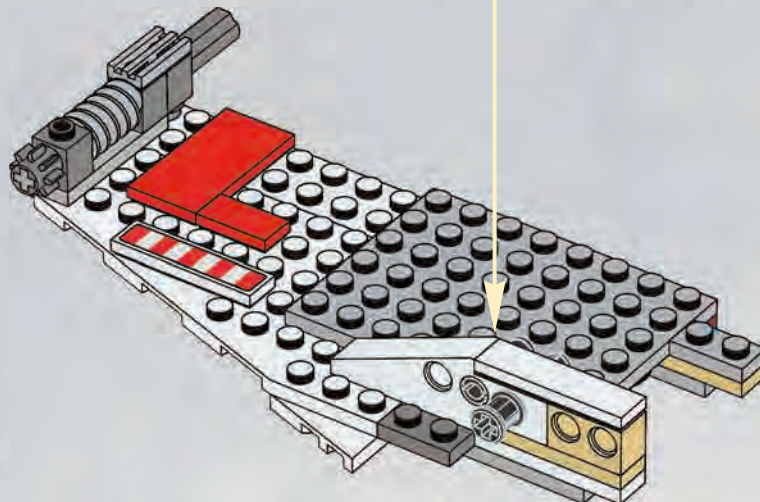
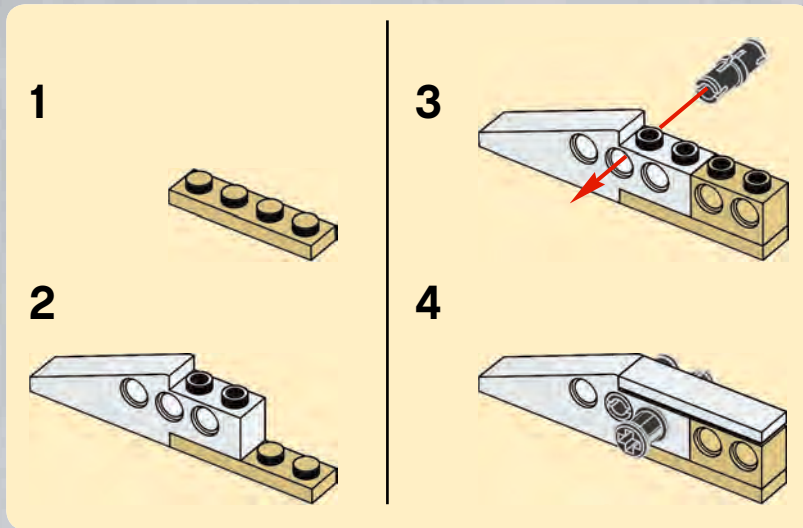





# 12

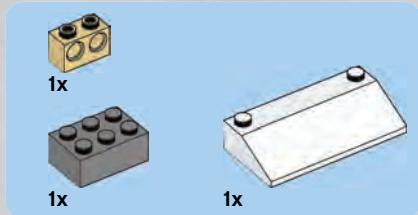
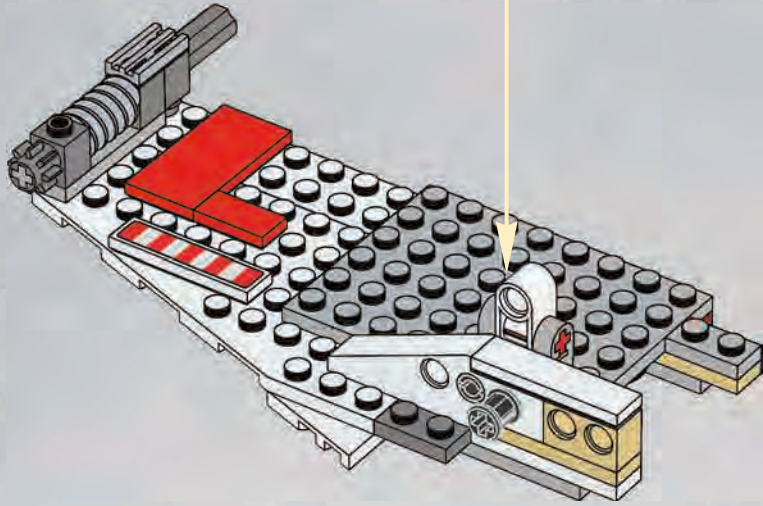
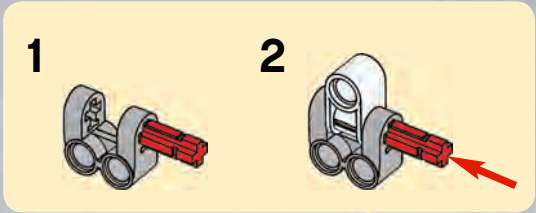

# 13

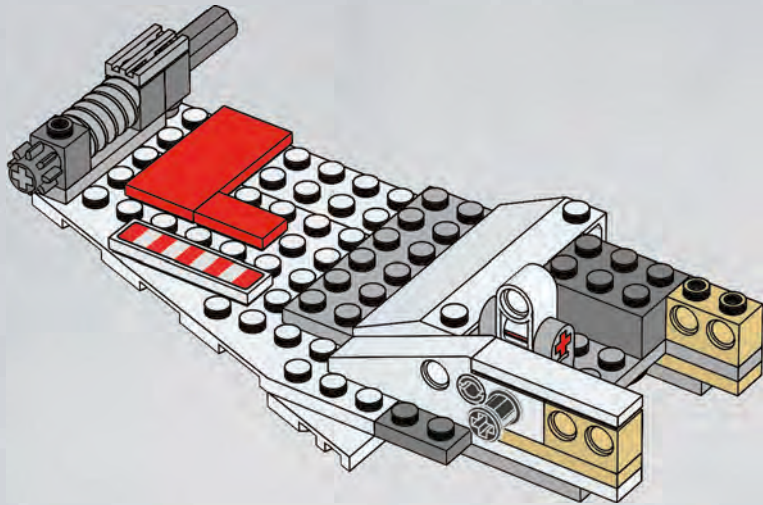

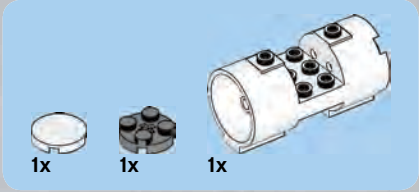

# 14

1

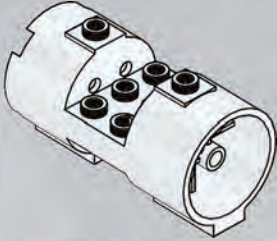

2

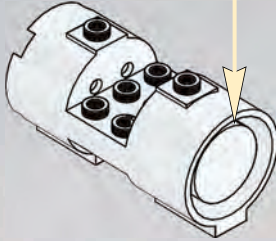

3

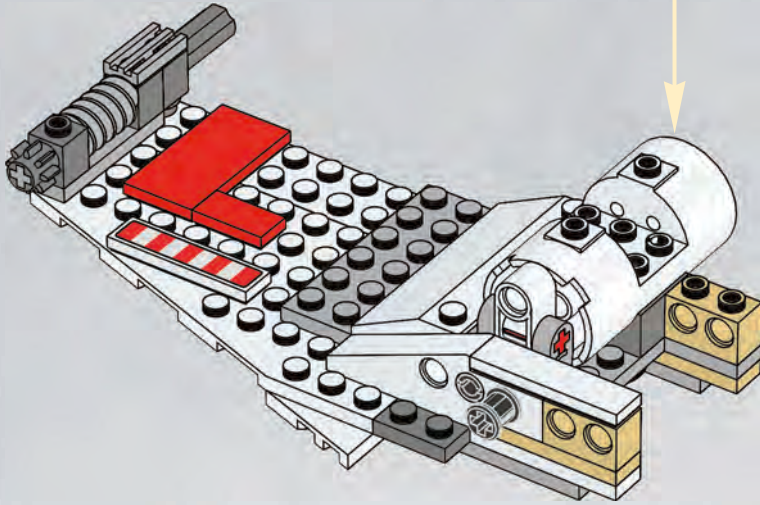
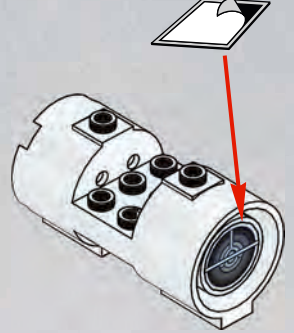



1x



1x



1x

# 15

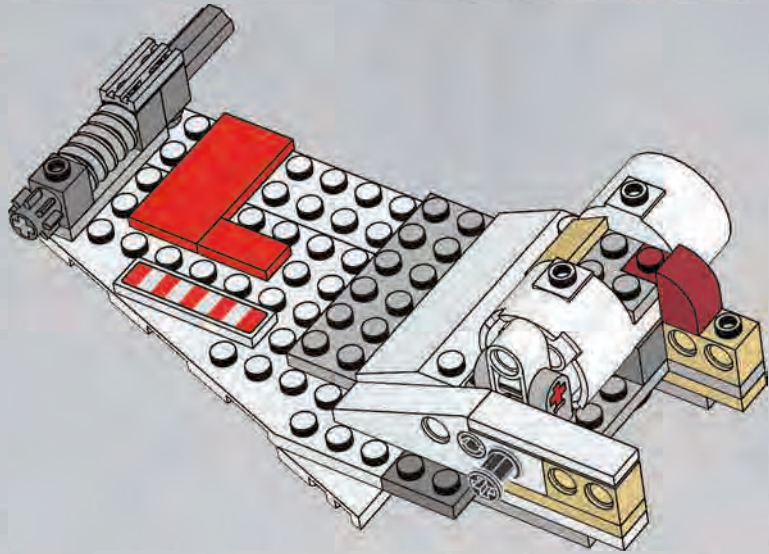

1x

# 16

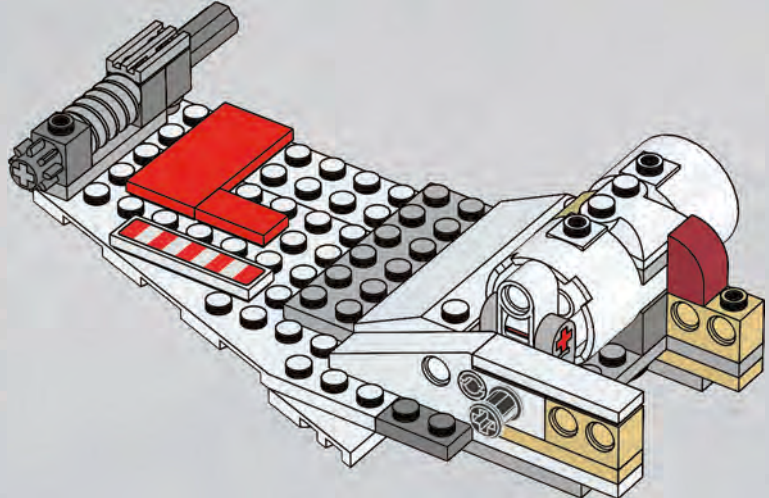

1x

# 17

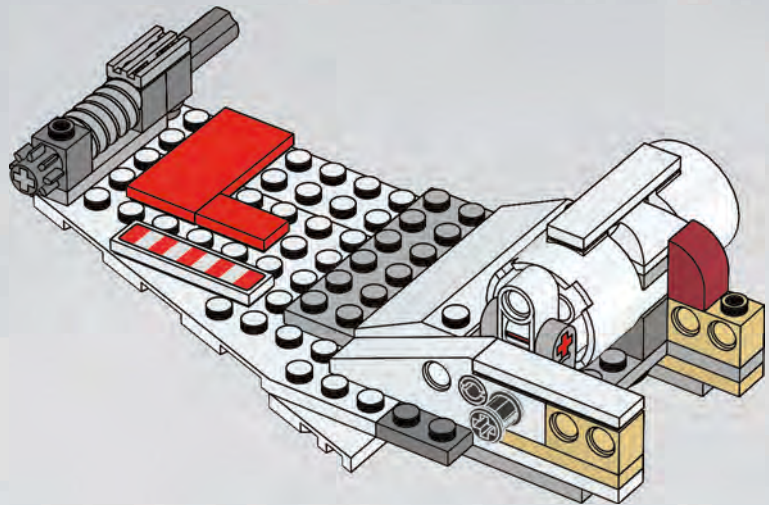

# 2x

53





18

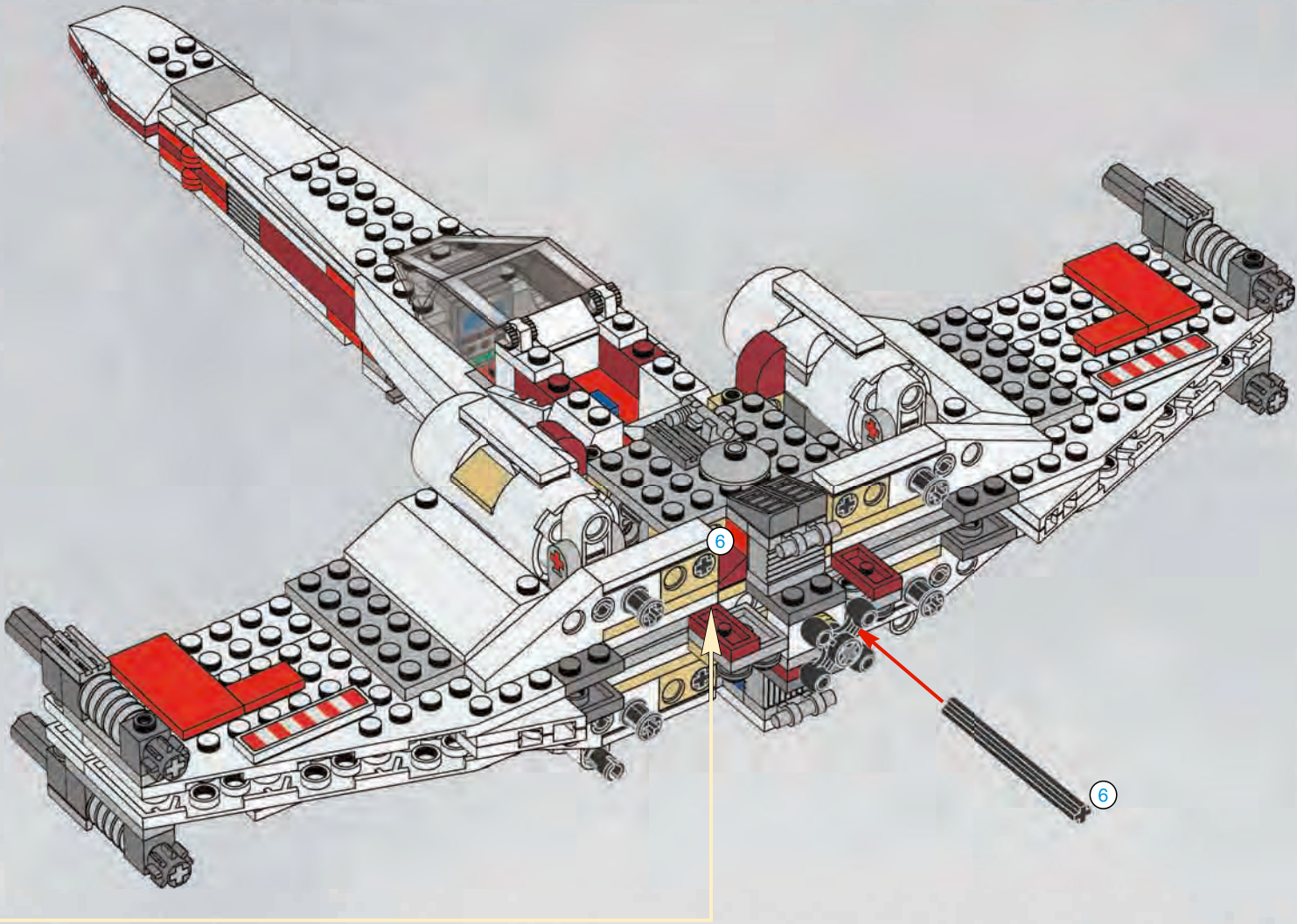



5

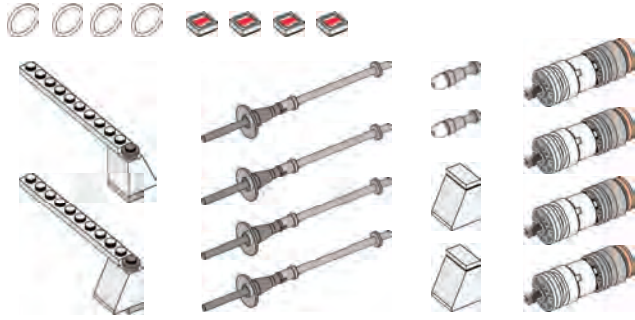

4x

19

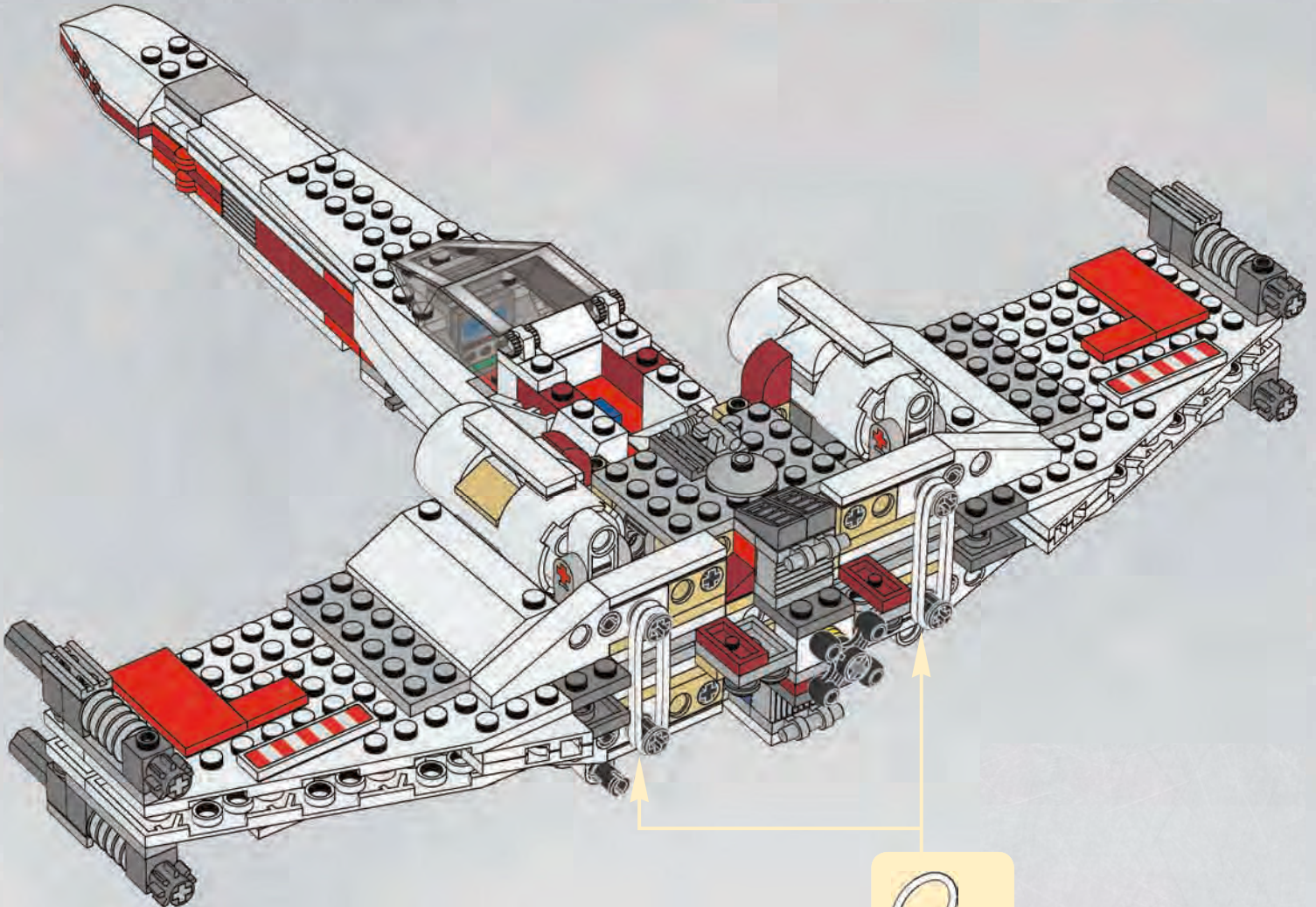

4x



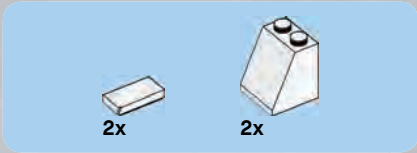

# 20

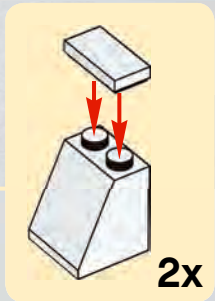
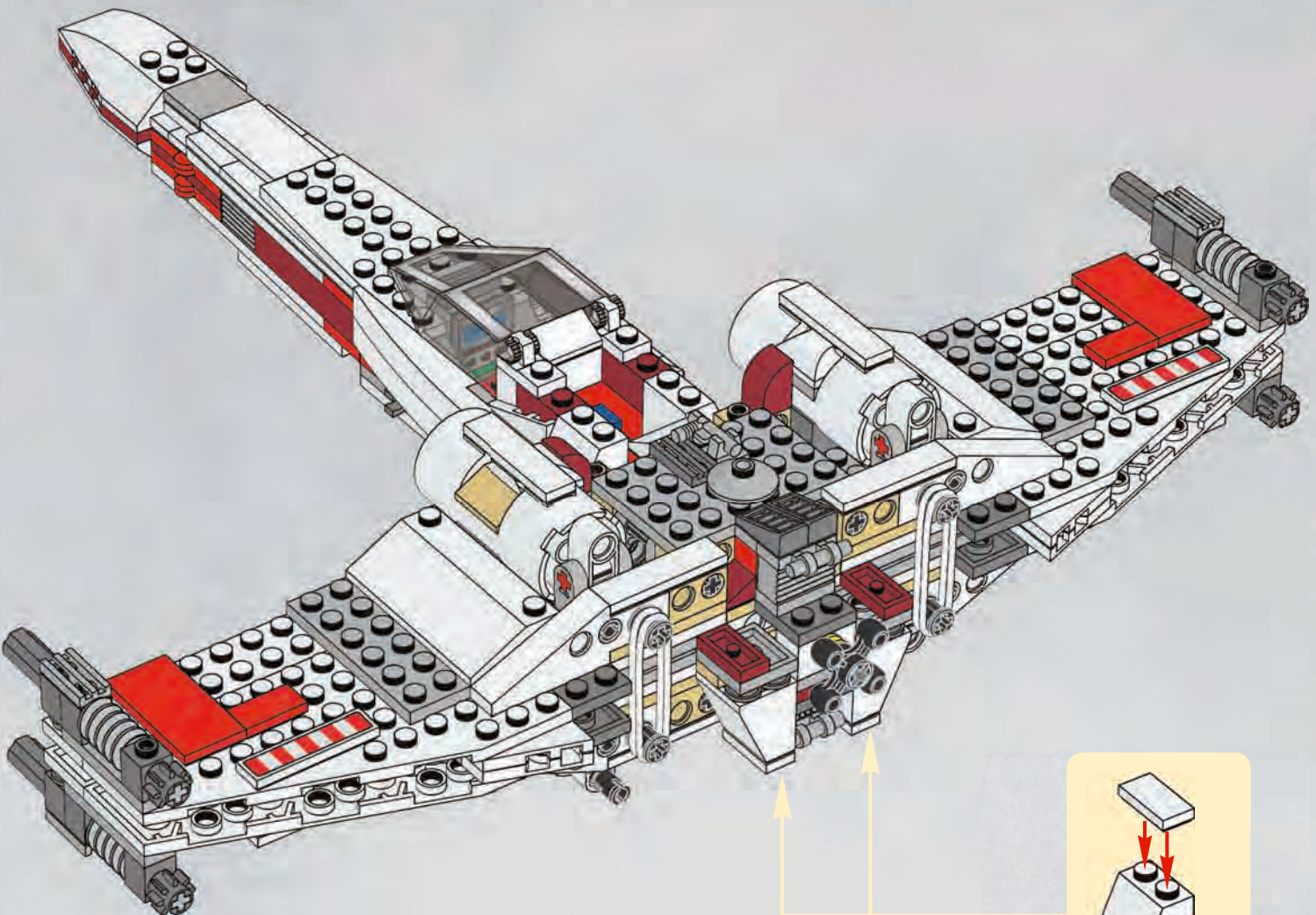



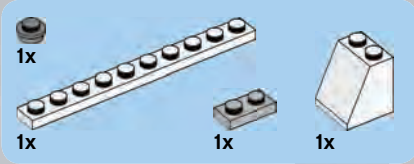

# 21

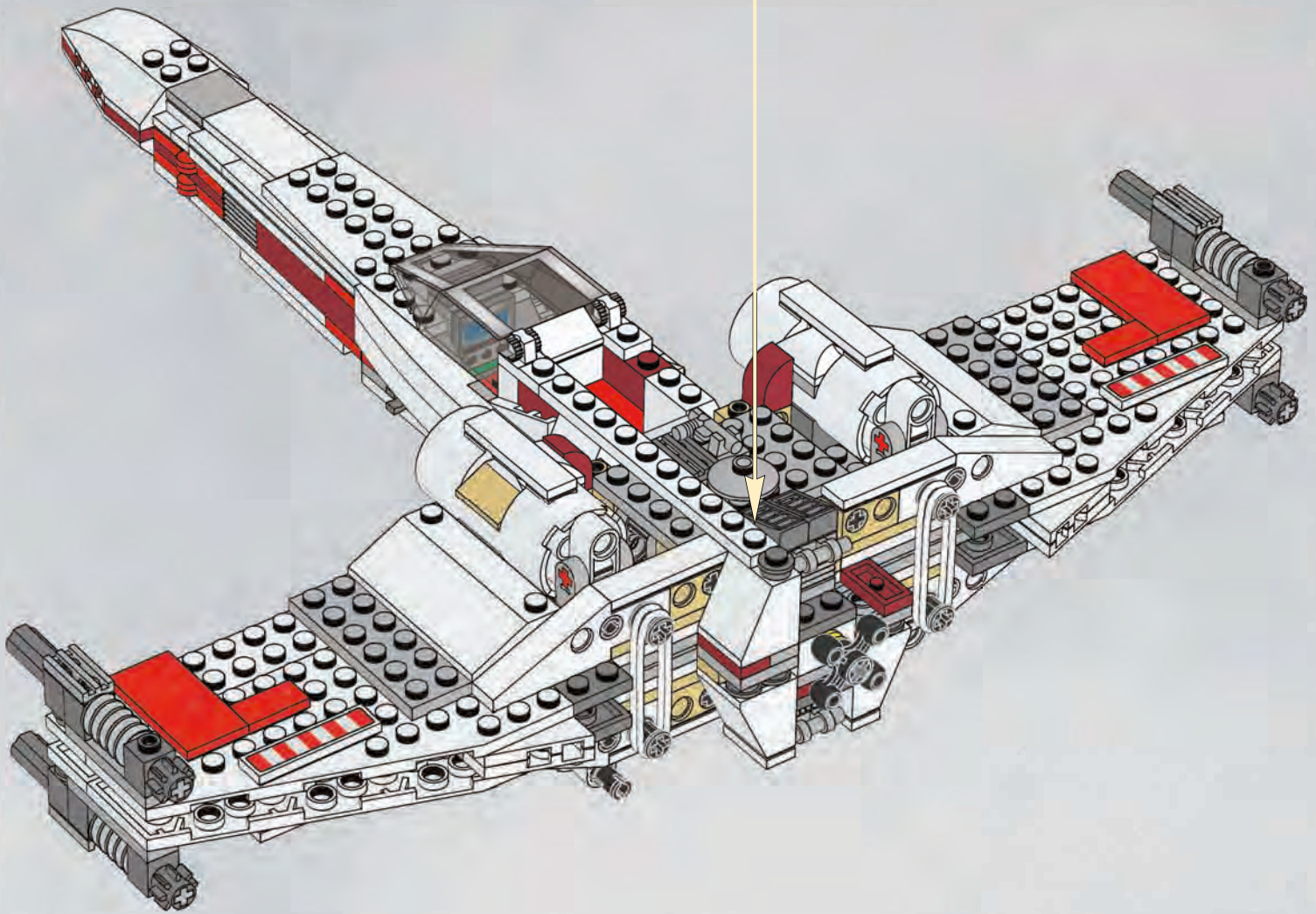
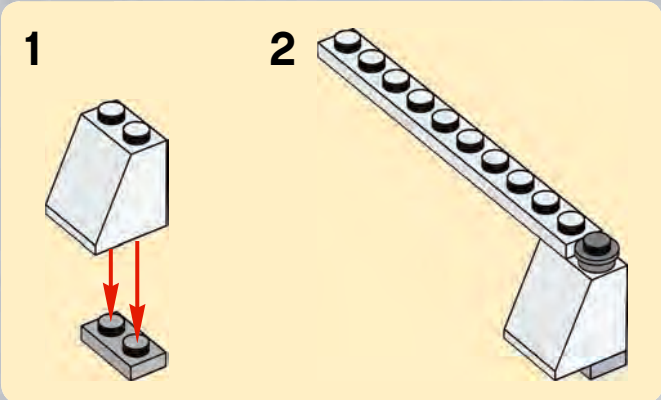

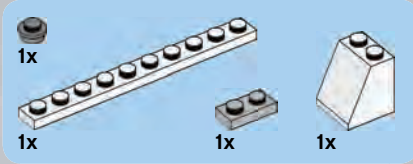

# 22

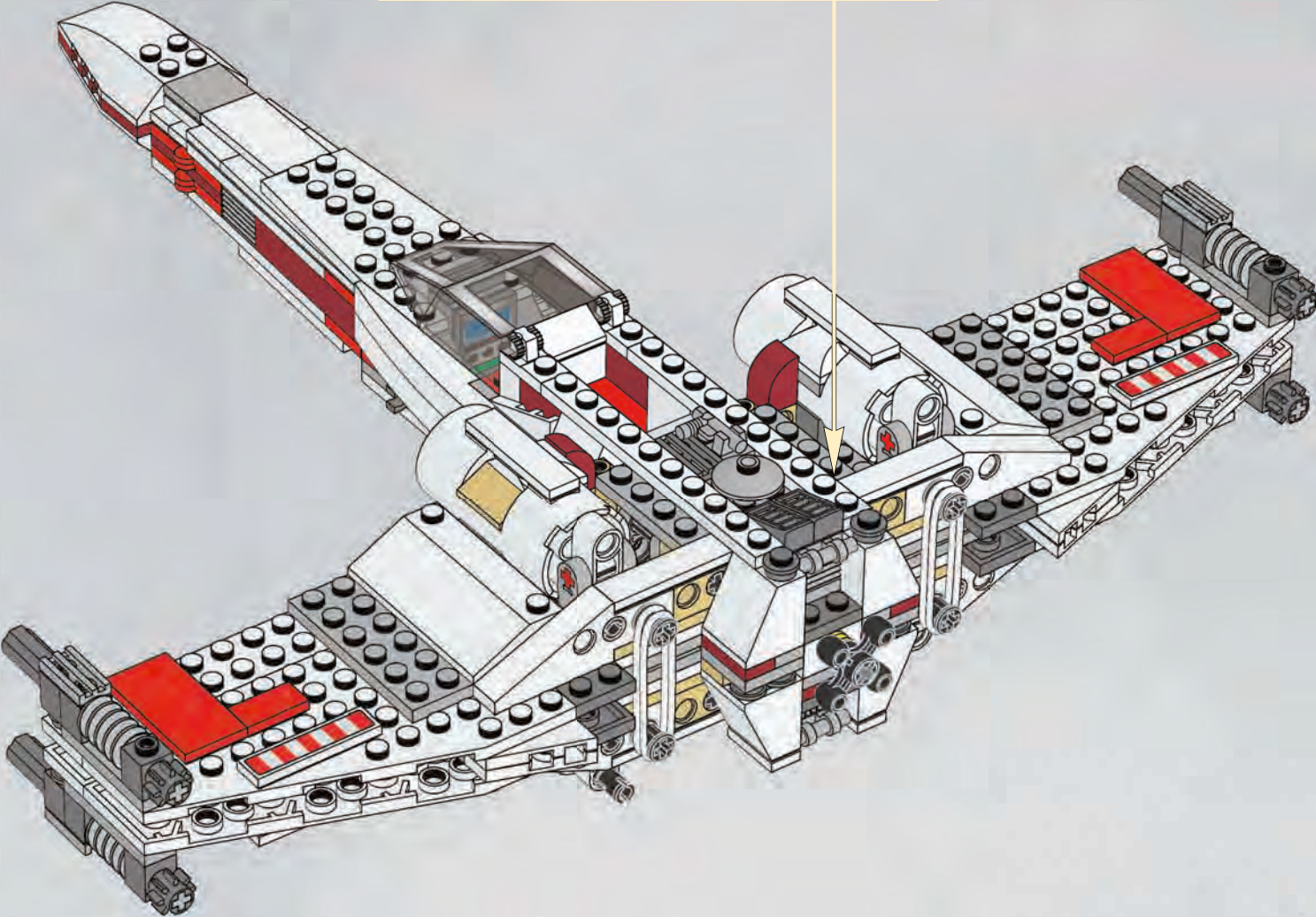
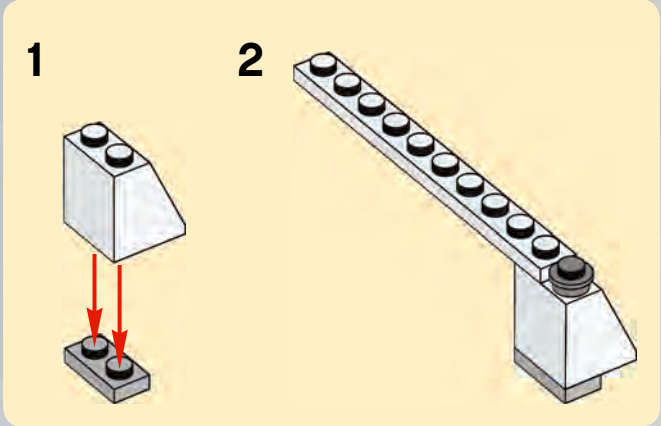





23

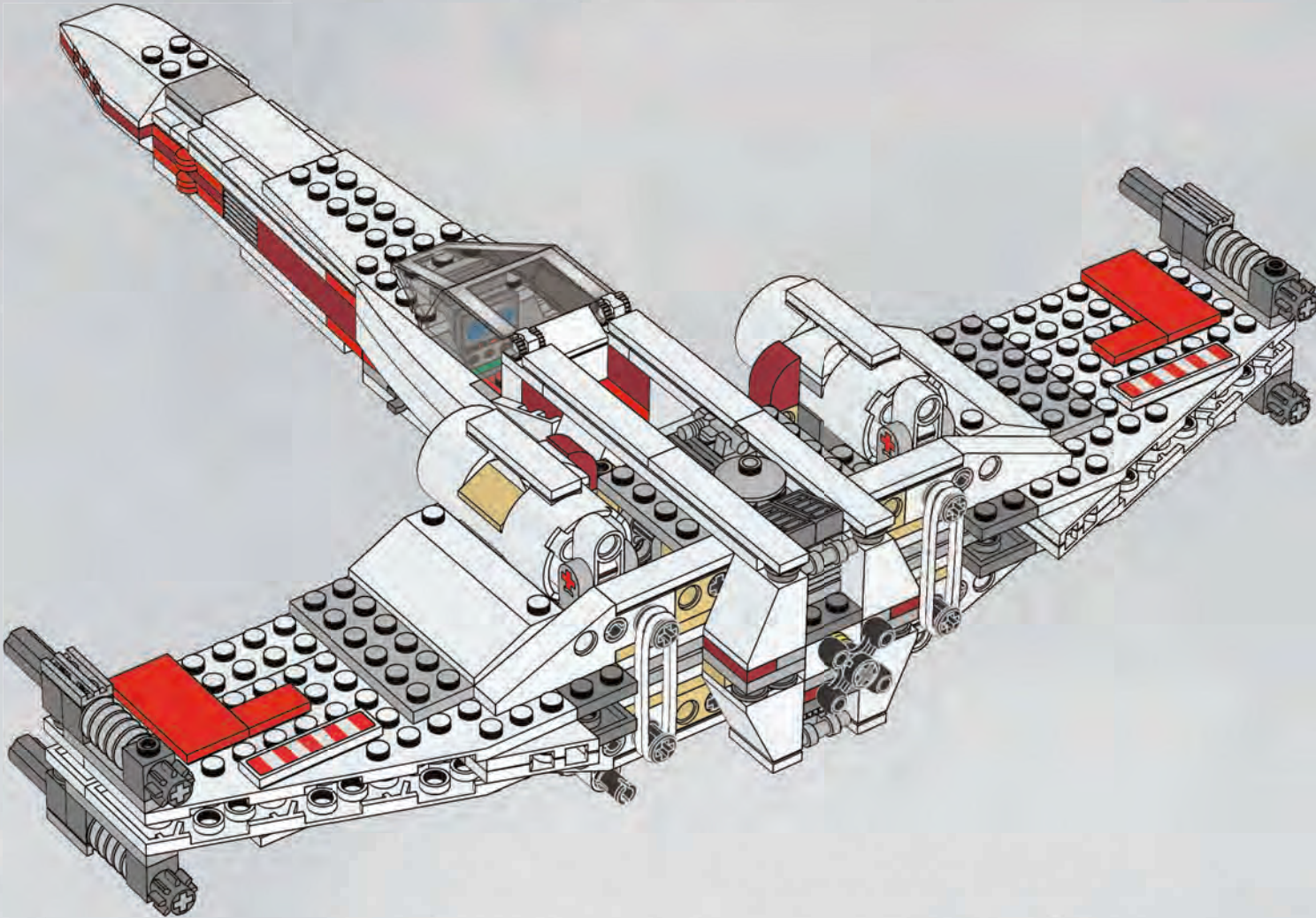





24

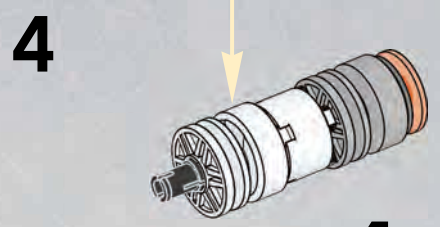
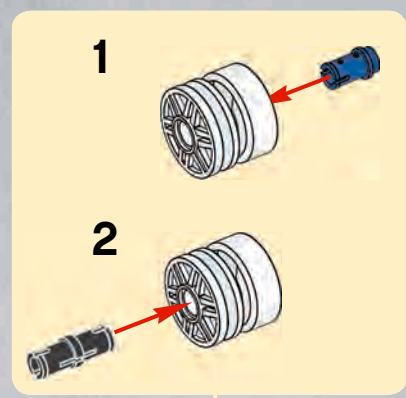
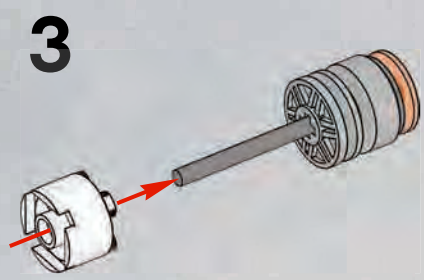
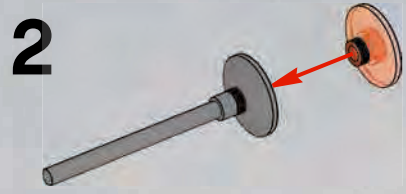

4x

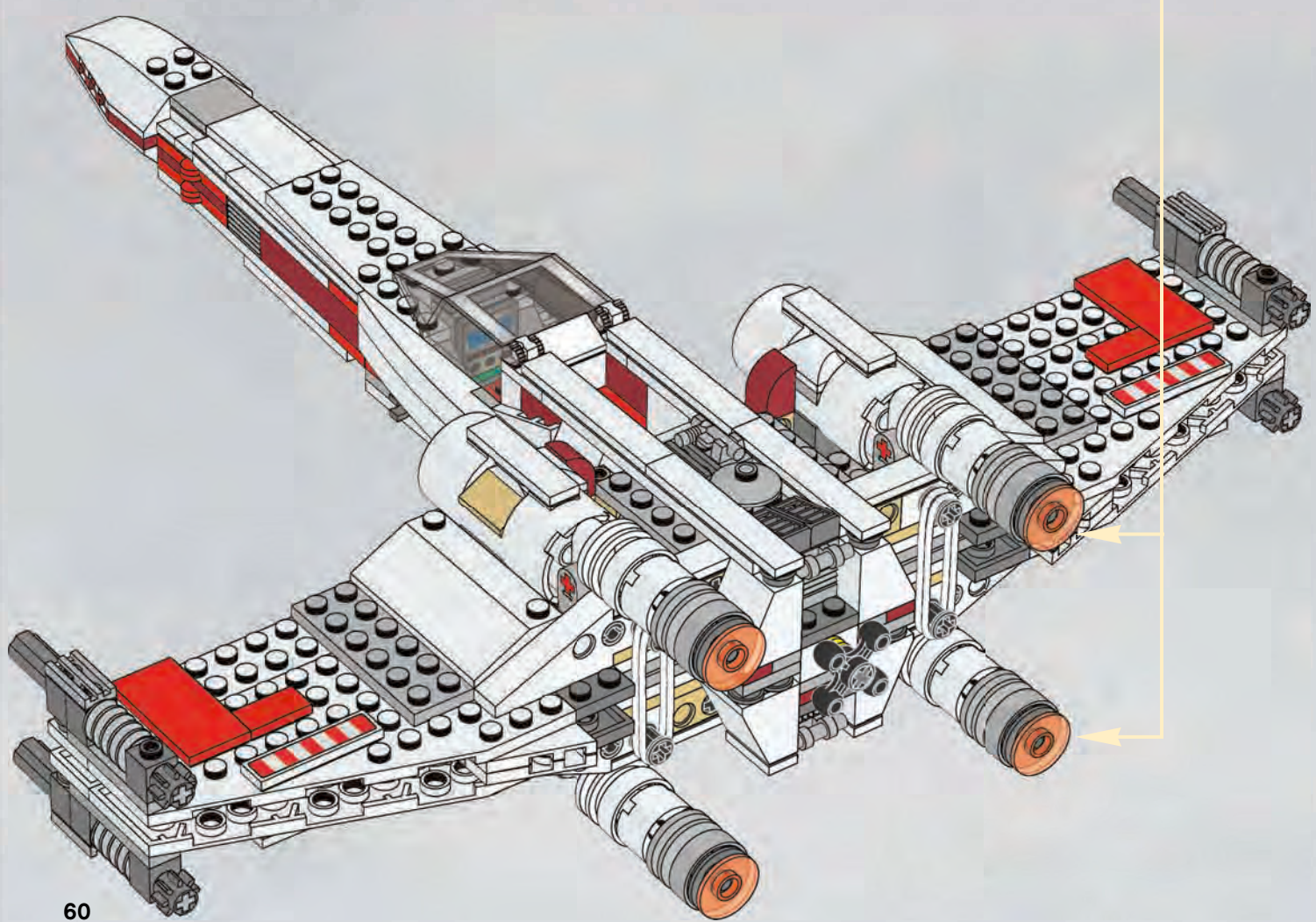

60



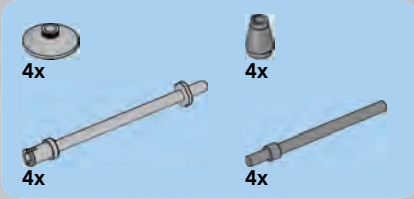

# 25

1



2

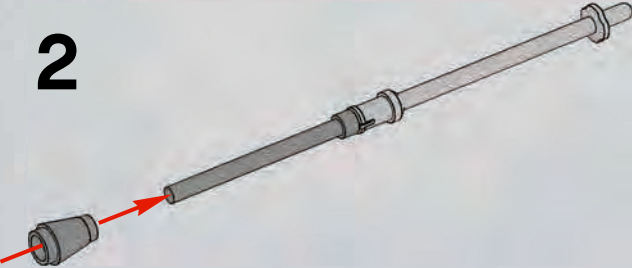

3

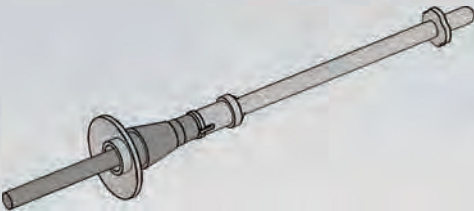

4x

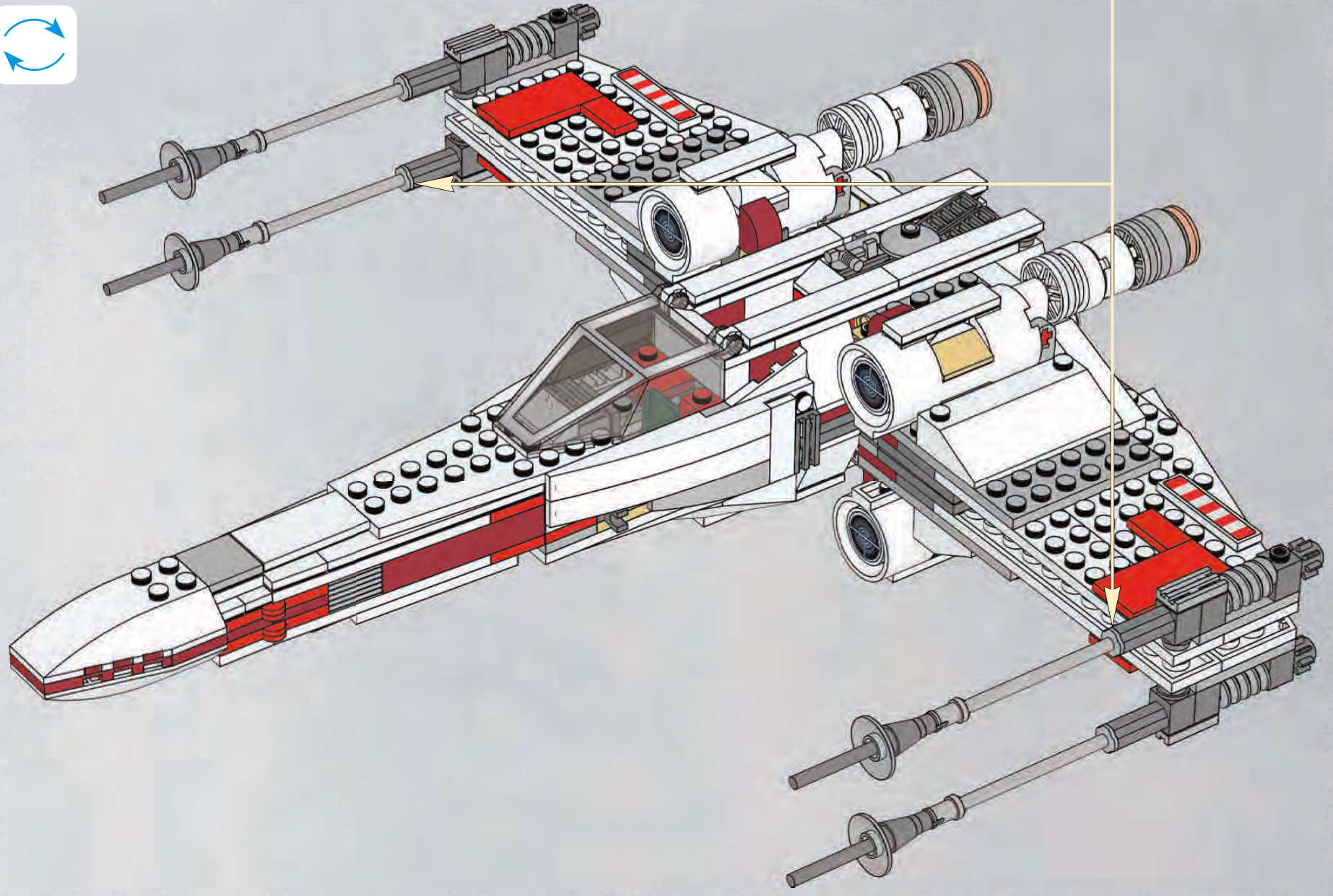





# 26

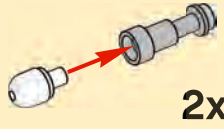

2x

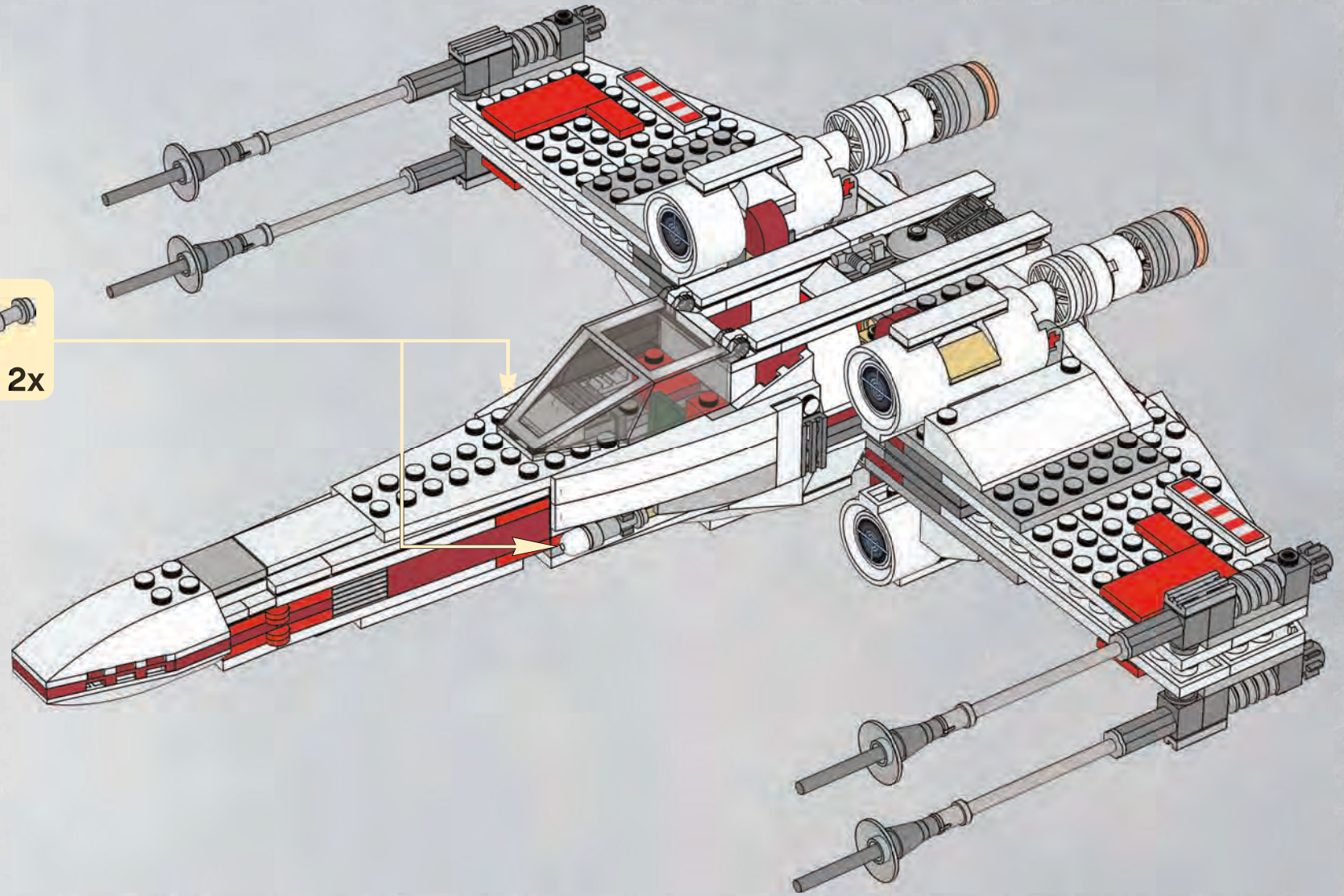



# 27

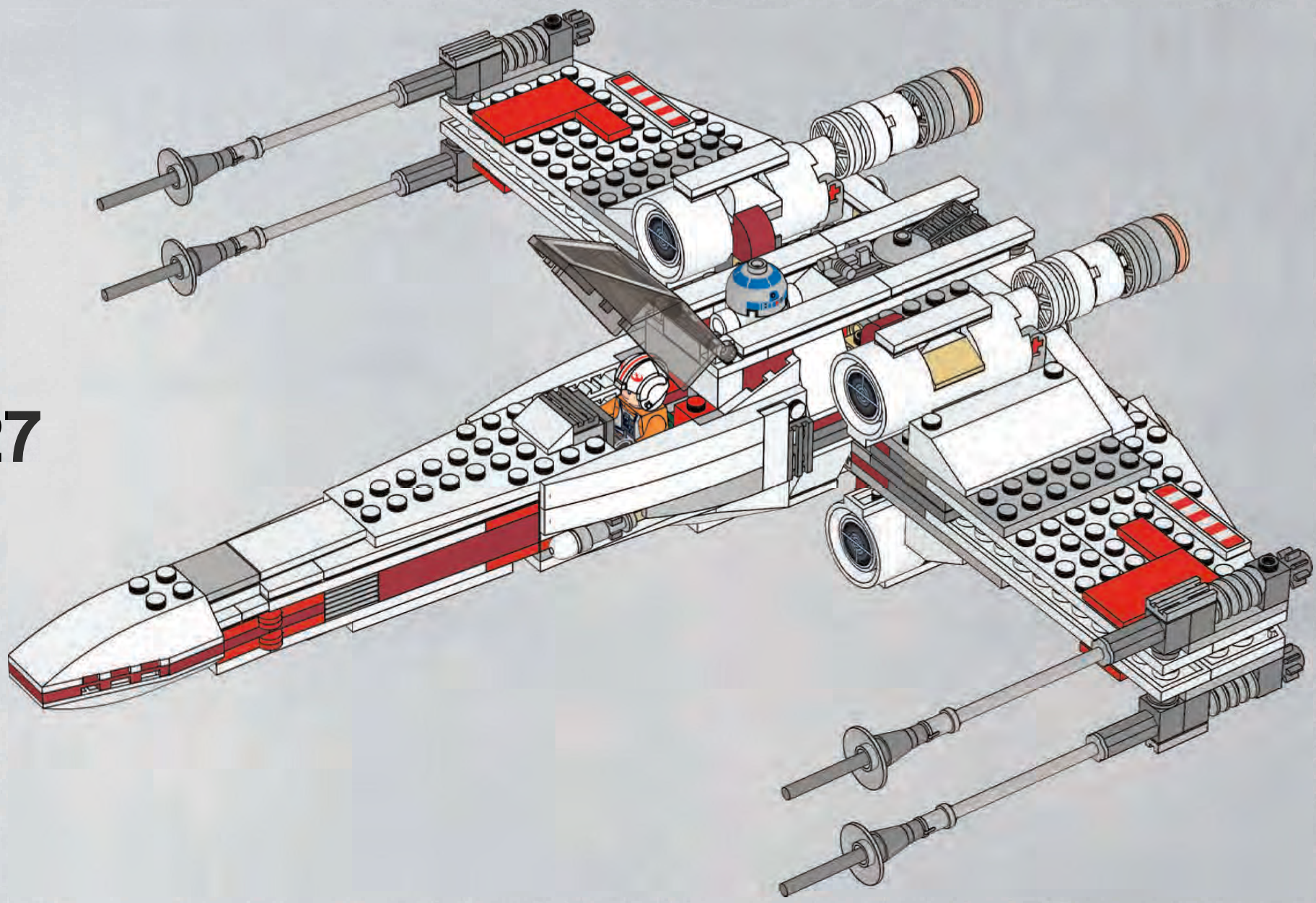



# 28

4x





1



2

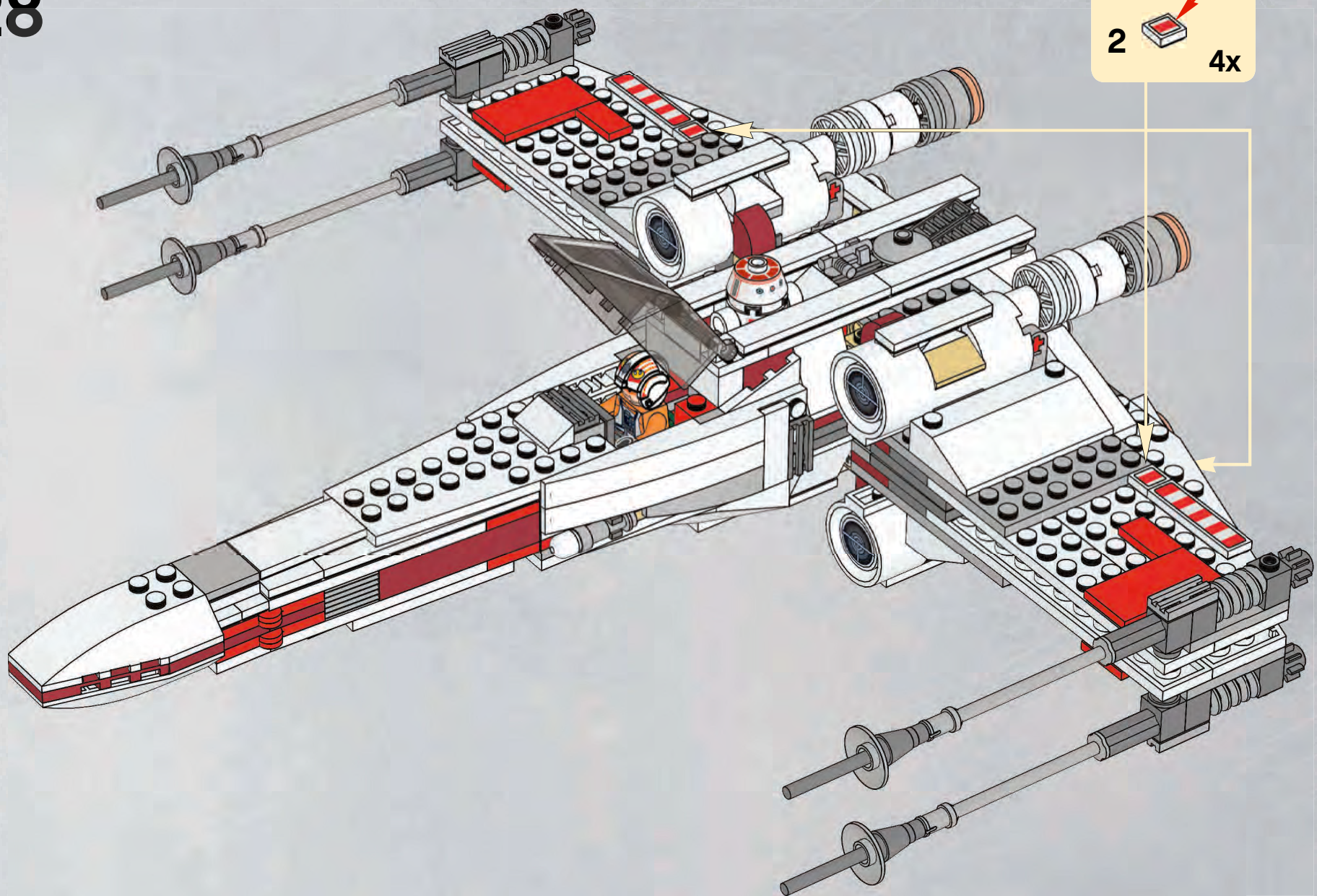

4x





1x 301001  
4x 614301  
1x 4194011  
1x 4655753  
1x 4587276  
4x 4629915  
3x 370001  
2x 370101  
4x 4528417  
3x 4547489  
8x 4234525  
1x 4567894  
4x 4547368  
1x 4261693  
1x 4179869  
4x 307001

2x 4623199  
4x 302101  
2x 302001  
4x 366601  
4x 346001  
5x 447701  
5x 244501  
4x 415001  
2x 4262011  
6x 306901  
4x 4558168  
12x 243101  
1x 4560178  
4x 663601  
2x 416201  
3x 4179874  
3x 4179875

2x 4141475  
2x 4141476  
2x 241301  
1x 4653823  
4x 371001  
4x 4490141  
4x 4124113  
4x 4569841  
4x 4494474  
4x 4544140  
4x 4173670  
20x 4523145  
4x 4624086  
14x 4113233  
5x 4124067  
12x 4278422  
1x 4514557

2x 300321  
4x 4157223  
1x 4207715  
4x 306921  
4x 4560179  
8x 74230  
5x 4227155  
6x 4142865  
1x 300123  
1x 300723  
2x 4119014  
5x 379423  
2x 4186834  
7x 4143005  
1x 4188313  
2x 4239601  
1x 329826  
1x 4498713  
1x 4158848  
3x 4107783  
8x 4121715

4x 4140801  
4x 370626  
1x 373726  
1x 4177431  
1x 4248204  
3x 4233489  
1x 4548731  
1x 4124073  
4x 3006347  
2x 4214921  
2x 4570764  
1x 4499899  
1x 4538760  
4x 4539102  
2x 4541528  
4x 4539082  
23x 4539097  
1x 4561032  
2x 4531415

1x 4533122  
2x 4211614  
2x 4532593  
13x 4211398  
10x 4211353  
5x 4211397  
6x 4211429  
8x 4599498  
3x 4612621  
1x 4243797  
4x 4211425  
1x 4211404  
2x 4251149  
4x 4211408  
1x 4211369  
4x 4211383  
4x 4211510  
2x 4526985

2x 4211414  
4x 4211350  
1x 4277927  
2x 4211632  
2x 4211413  
2x 4211804  
1x 4211802  
5x 4211512  
2x 4657366  
1x 4514195  
4x 4490127  
4x 4211859  
4x 4503416  
4x 4211889  
2x 4211550  
3x 4211815  
1x 4211639  
4x 4211805  
1x 4655786  
1x 4569715

**Customer Service**  
Kundenservice  
Service Consommateurs  
Servicio Al Consumidor  
[www.lego.com/service](http://www.lego.com/service) or dial  
00800 5346 5555 :   
1-800-422-5346 :



- 4x 4211105
- 4x 4529240
- 12x 4210639
- 2x 4621917
- 1x 421054
- 2x 4211043
- 4x 4539429
- 2x 4211002
- 6x 4210997
- 2x 45779354
- 4x 4210631
- 1x 4514441
- 27x 4210633
- 4x 4211042
- 4x 4211010
- 8x 4538721
- 2x 4540386
- 4x 4211050
- 4x 4516546
- 2x 4508553
- 4x 4514559

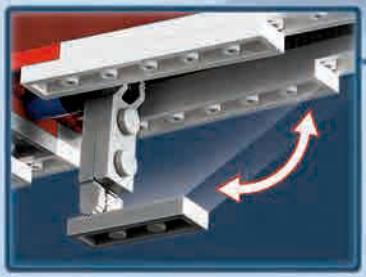
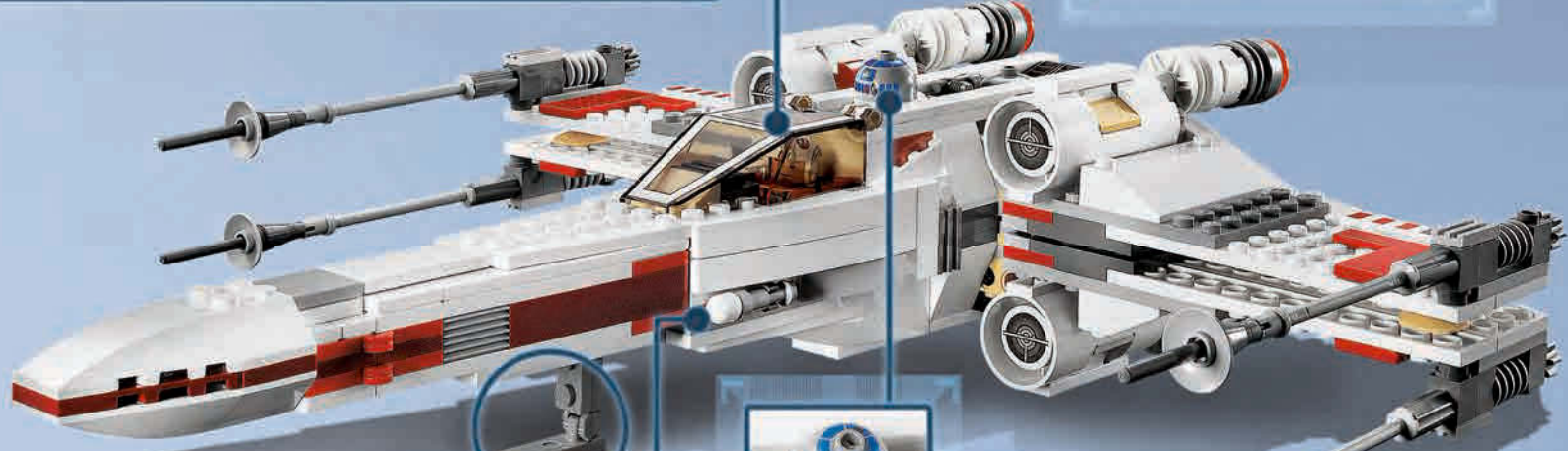

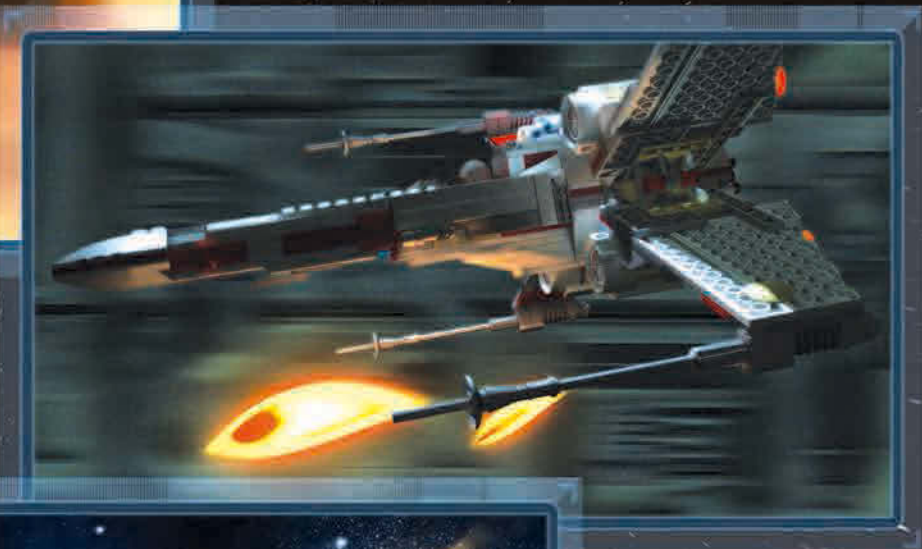





9493



9492



9491



9490



9489



9488



9488



9489



9490



9491



9492



9493



9488



9489



9490



9491



9492



9493



9488



9489



9490



9491



9492



9493



9488



9489



9490



9491



9492



9493



# ACE ASSAULT II



0704



starwars.LEGO.com





[www.LEGOclub.com](http://www.LEGOclub.com)



**FREE! GRATIS! GRATUIT!**



**LEGO® Club Magazine**



**LEGO® Club Email**

**SIGN UP ONLINE!**  
[www.LEGOclub.com](http://www.LEGOclub.com)

VISIT THE WORLD'S  
BIGGEST LEGO® SHOP!  
[www.LEGOshop.com](http://www.LEGOshop.com)

GO TO  
[www.LEGOclub.com](http://www.LEGOclub.com)

00800 5346 5555\*

1-866-534-6258 • 1-877-518-5346

US & Canada only

Canada seulement



\* Freephone. Mobile charges may apply. \* Numéro sans frais. Des frais peuvent s'appliquer avec les téléphones cellulaires. \* Gebührenfrei, Kosten für Anrufe aus Mobilfunknetzen können abweichen. \* Gratis telefoonnummer vanaf vaste lijn. \* Det er et gratis nummer, når du ringer fra fasttelefon. \* Det är gratis, när du ringer från en fast telefon. \* Numéro sans frais. Des frais peuvent s'appliquer avec les téléphones portables.

FLY11





# WIN!

Go to [www.LEGOsurvey.com/product](http://www.LEGOsurvey.com/product) to fill out a survey for a chance to win a cool LEGO® Product.

No purchase necessary.

Open to all residents where not prohibited.

 [www.LEGO.com](http://www.LEGO.com)



# [www.LEGOsurvey.com/product](http://www.LEGOsurvey.com/product)

## GEWINNE!

Nimm an der Umfrage auf [www.LEGOsurvey.com/product](http://www.LEGOsurvey.com/product) teil und hab die Chance ein cooles LEGO® Produkt zu gewinnen! Die Teilnahme am Gewinnspiel führt zu keinerlei Kaufverpflichtungen. Teilnahme in allen nicht ausgeschlossenen Ländern möglich.

## WIN!

Ga naar [www.LEGOsurvey.com/product](http://www.LEGOsurvey.com/product), vul een enquêteformulier in en maak kans op een cool LEGO® product. Geen aankoopverplichting. Iedereen mag deelnemen, uitgezonderd ingezetenden van landen waar een enquêteverbod geldt.

## GAGNE!

Visite [www.LEGOsurvey.com/product](http://www.LEGOsurvey.com/product) pour répondre à un questionnaire et avoir une chance de gagner un produit LEGO® très cool! Aucune obligation d'achat. Ouvert à tous les résidents des pays autorisés.

## 当てよう!

[www.LEGOsurvey.com/product](http://www.LEGOsurvey.com/product) にアクセスして、アンケートにご記入ください。当選者にはレゴ®製品を差し上げます。お買い上げの必要はありません。禁止されていない限り、すべての皆様にご利用いただけます。



1

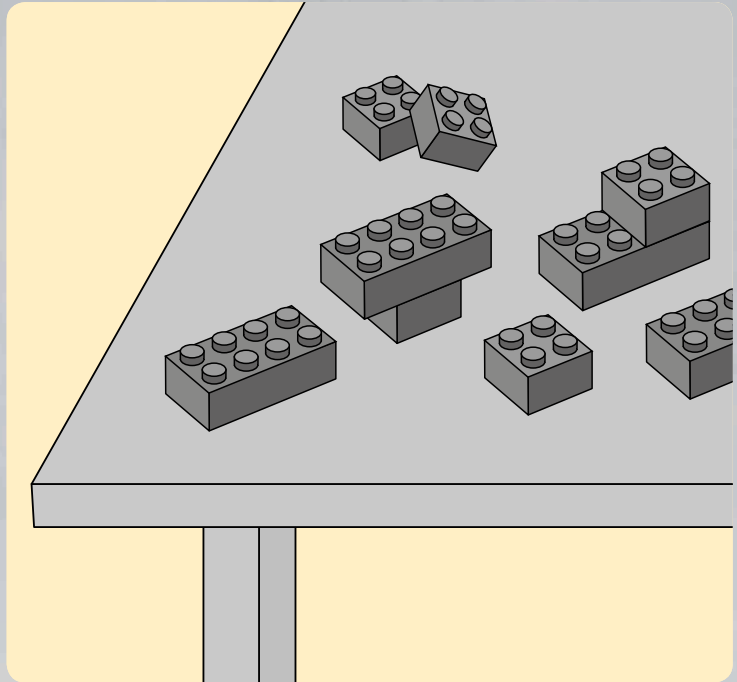
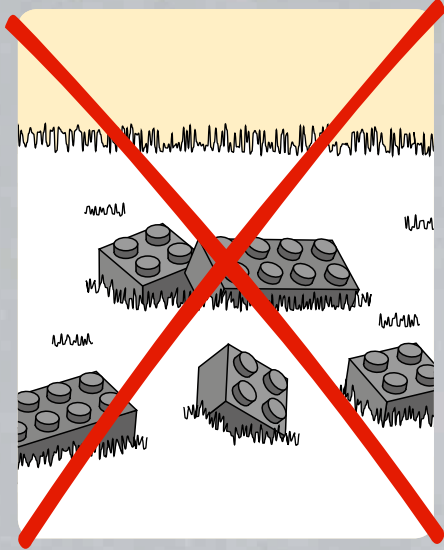

2

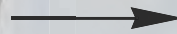

2

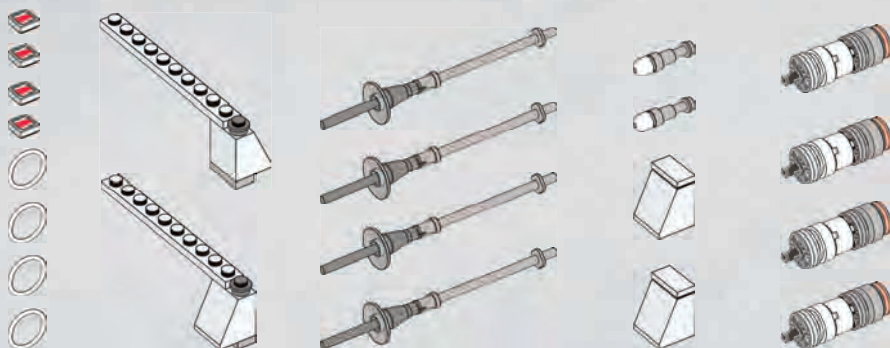
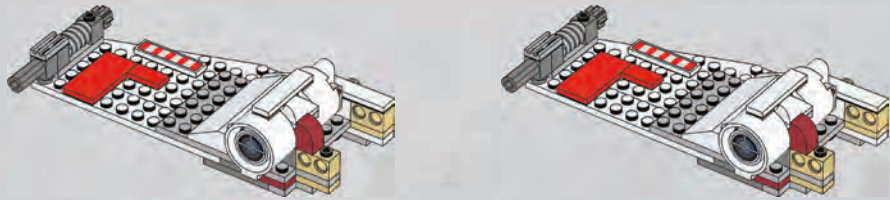
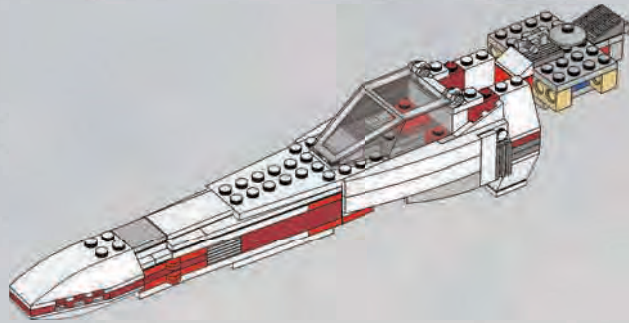
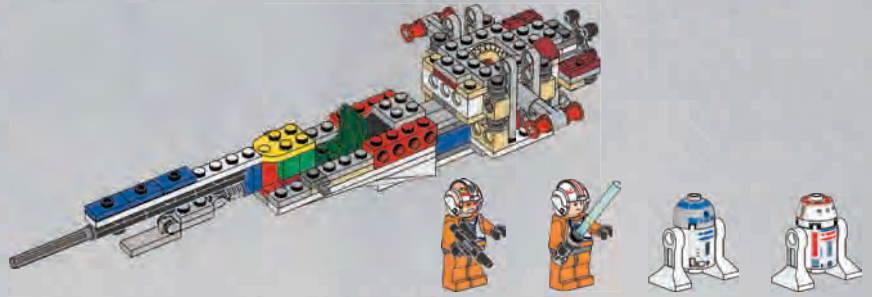



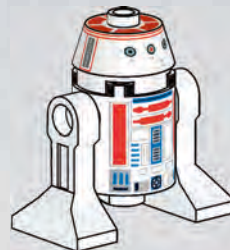
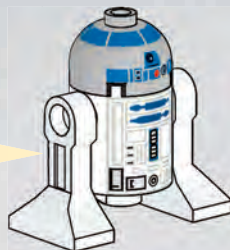
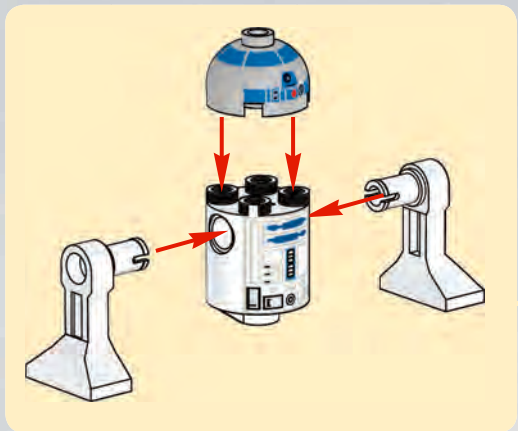
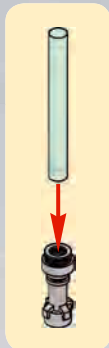
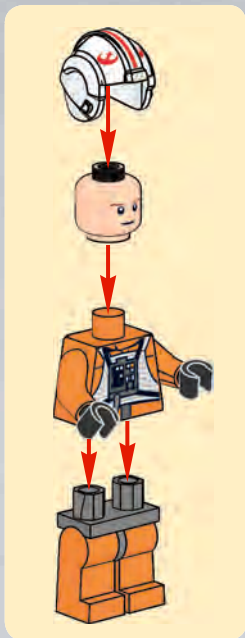
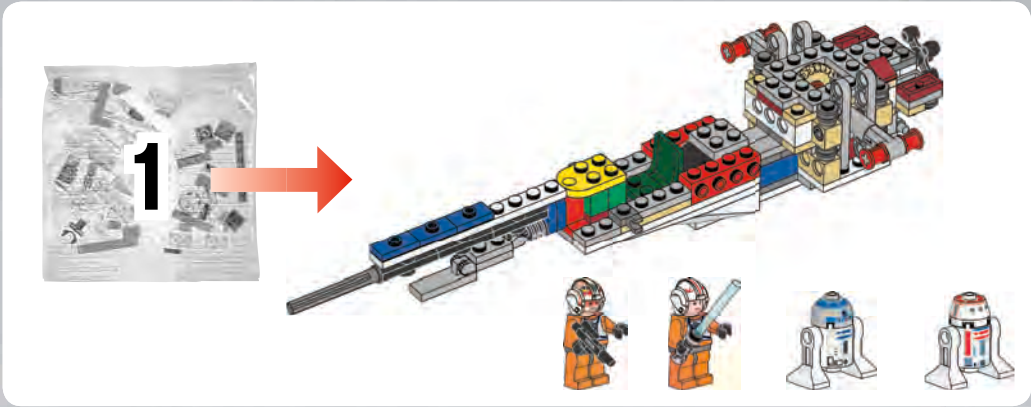

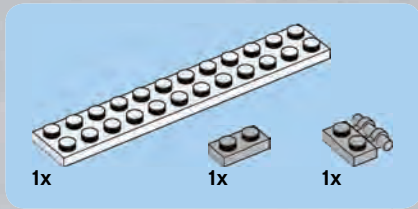

1

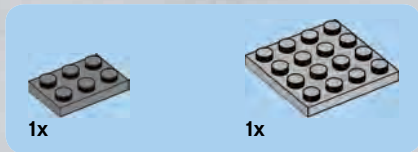
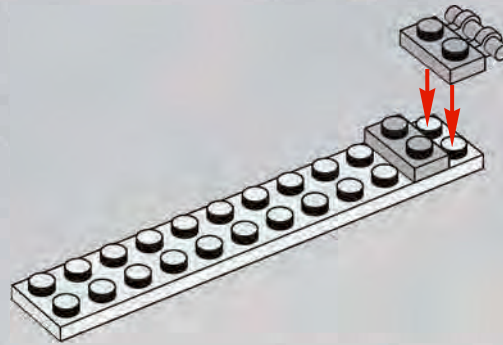

2

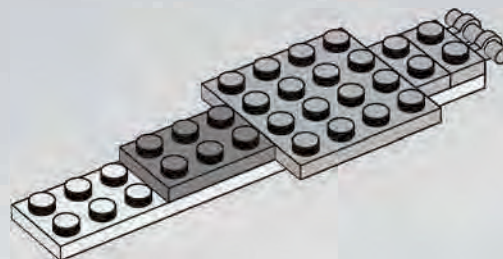



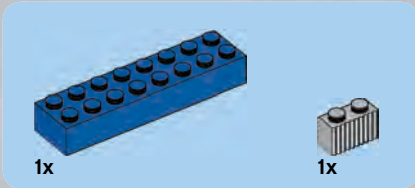

3

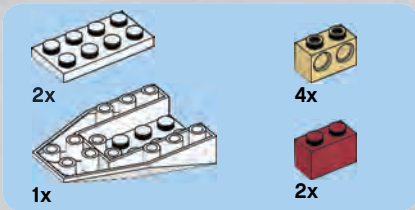
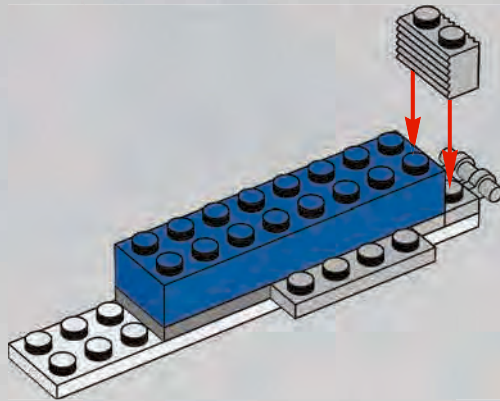

4

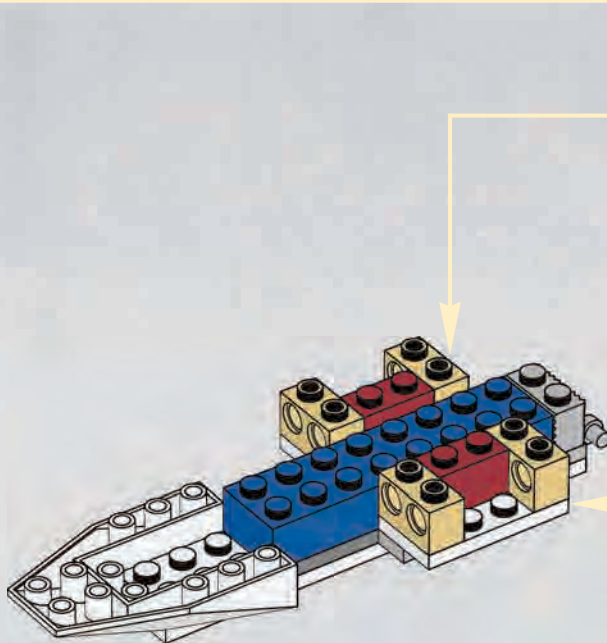
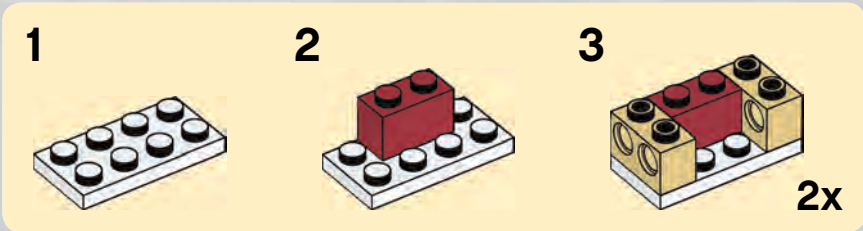

6

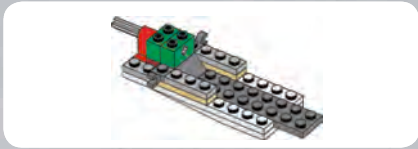

1

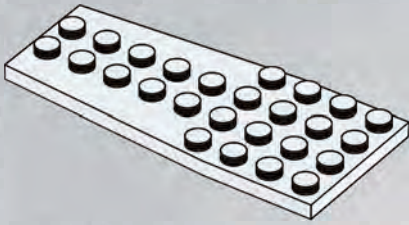

2

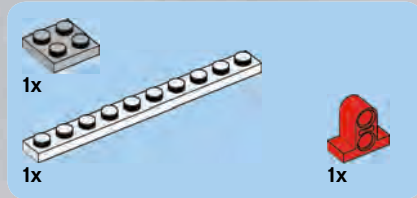
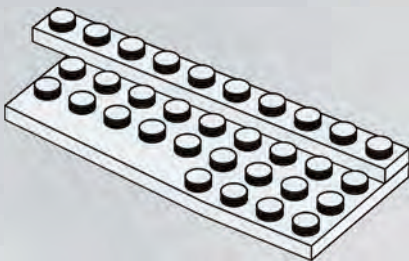

3

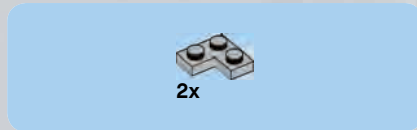
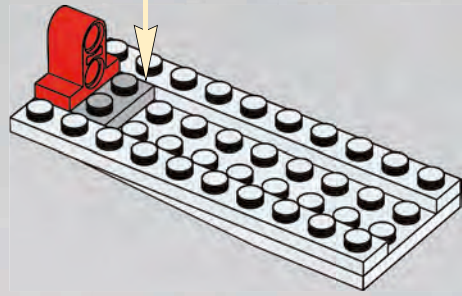
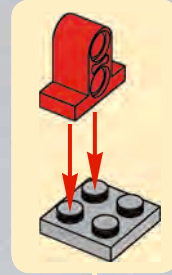

4

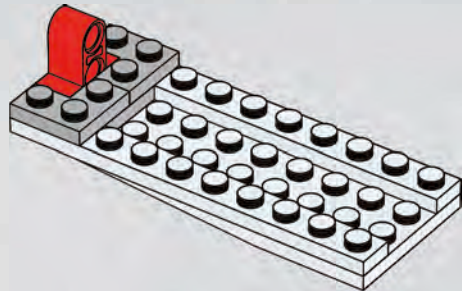





2x



1x

5

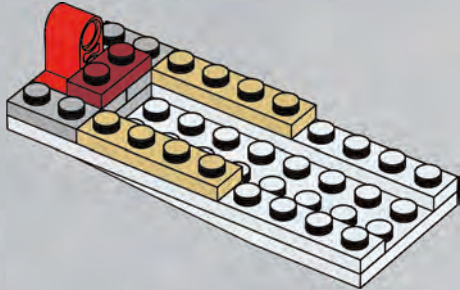

1x



1x

6

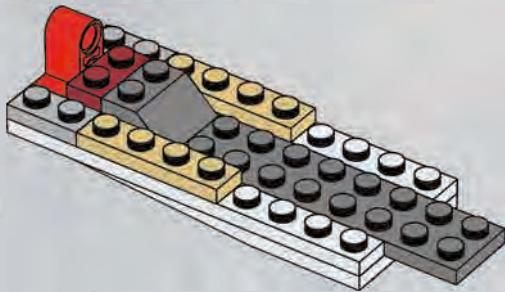

2x



2x

7

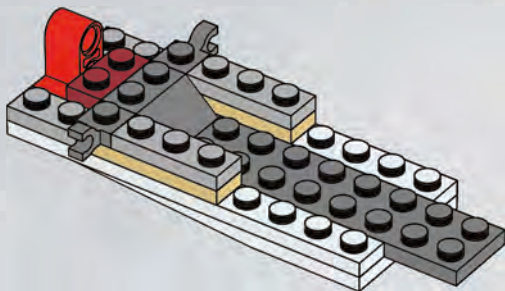

8



2x

8

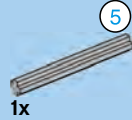
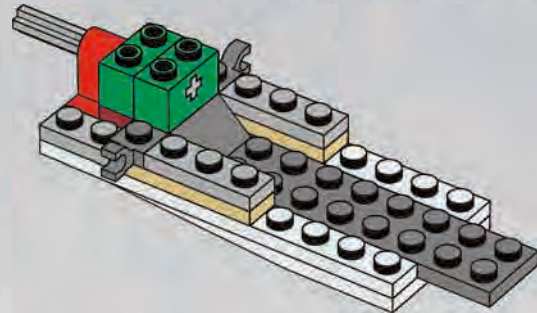

1x

9

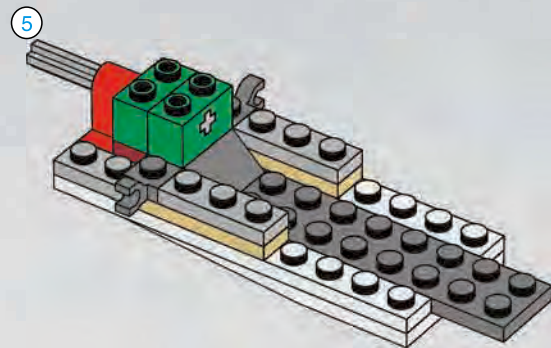

5 1:1

5

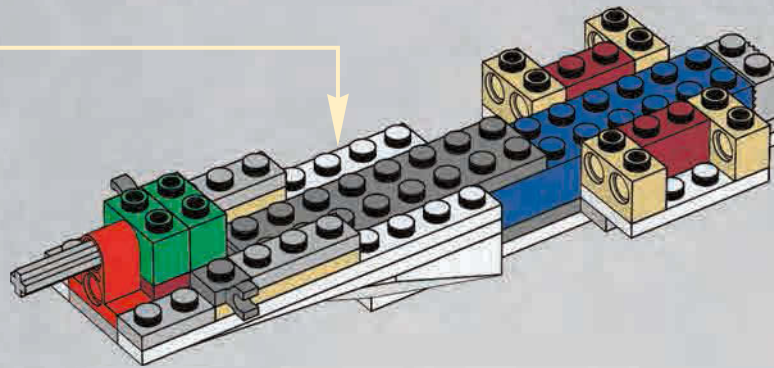

6

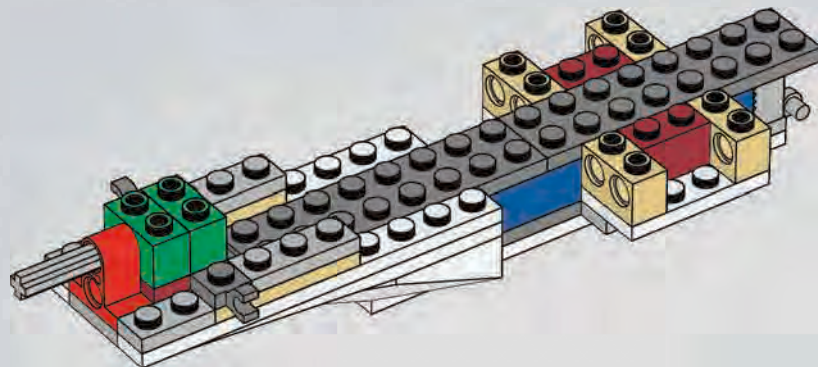





7

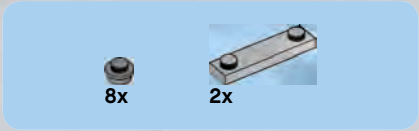
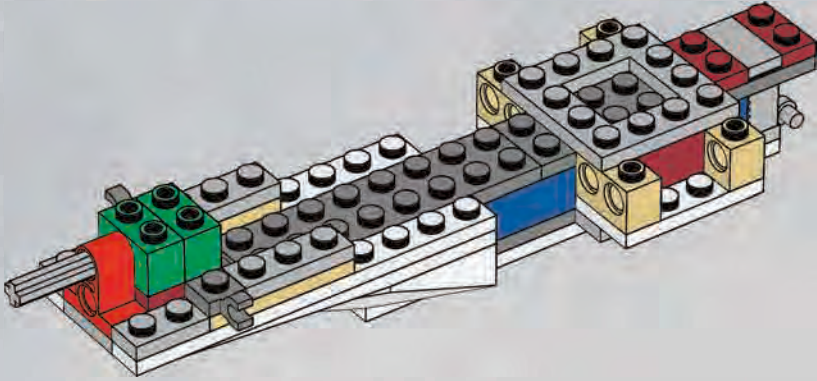

8

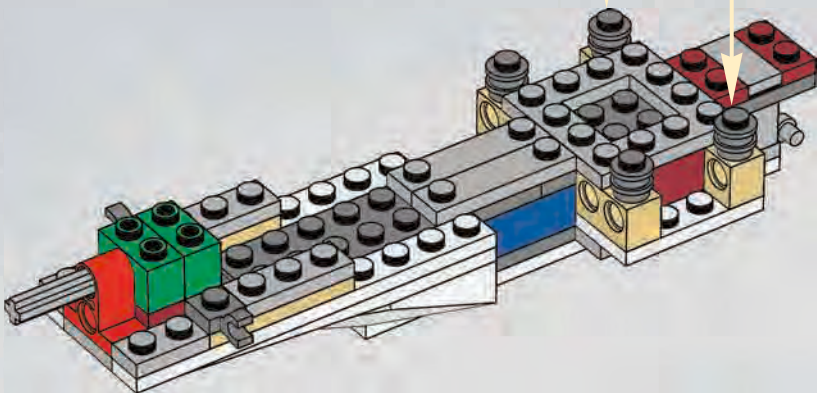
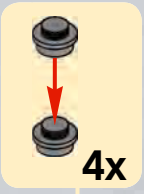

10



2x



2x

# 9

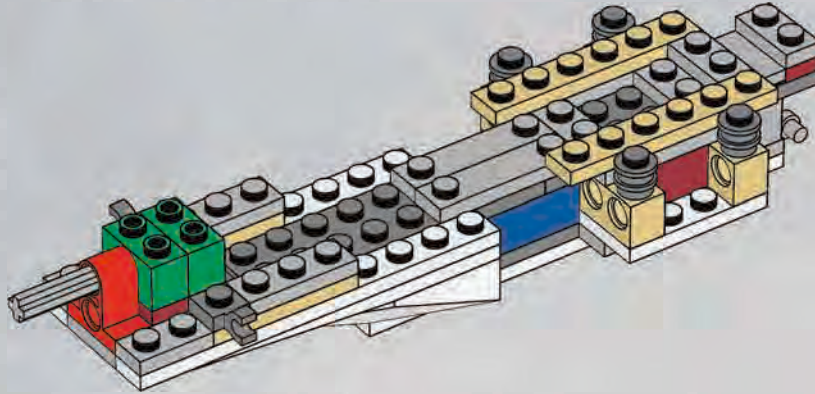

1x



1x

# 10

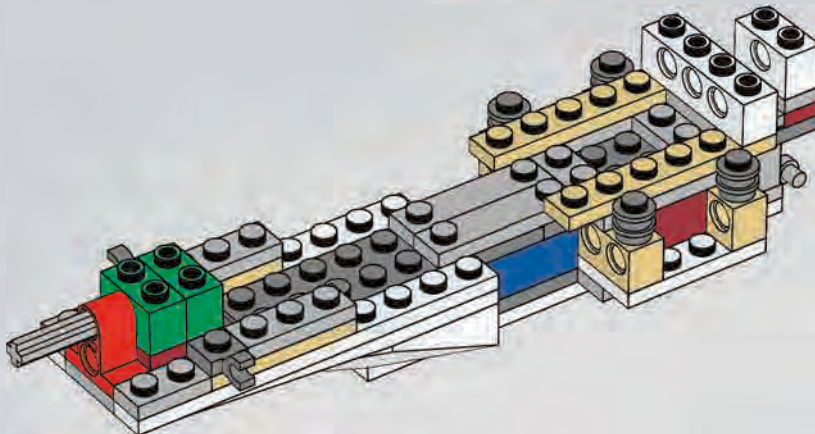



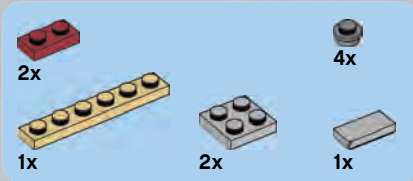

# 11

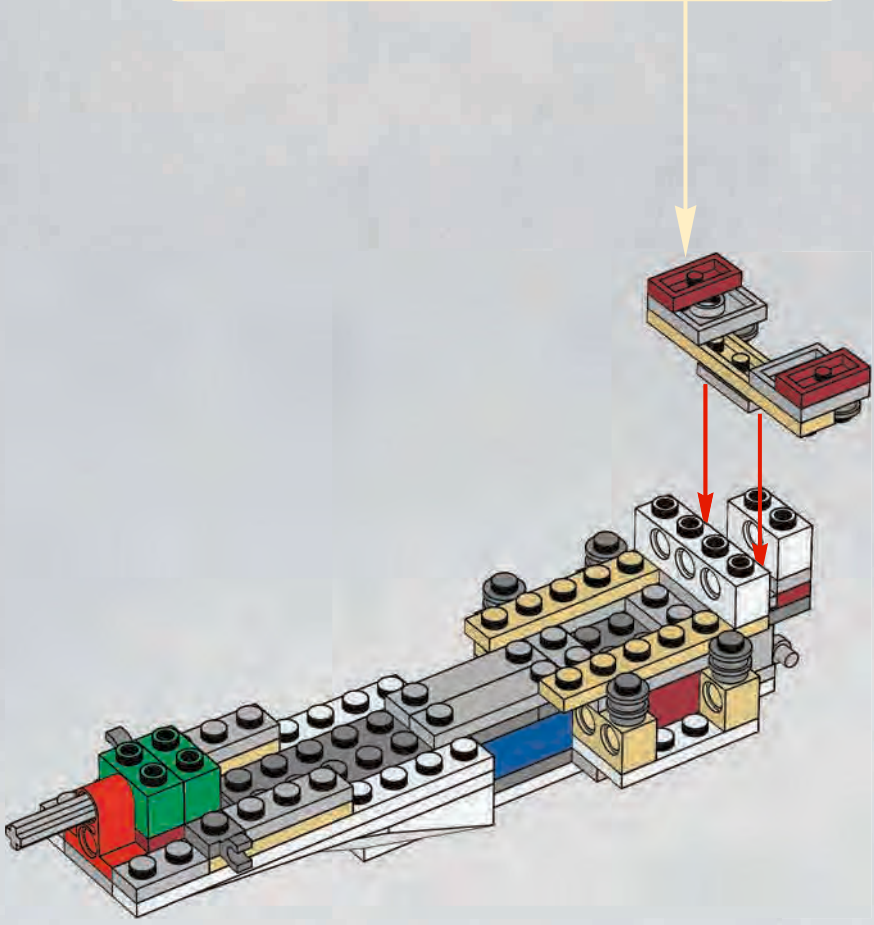
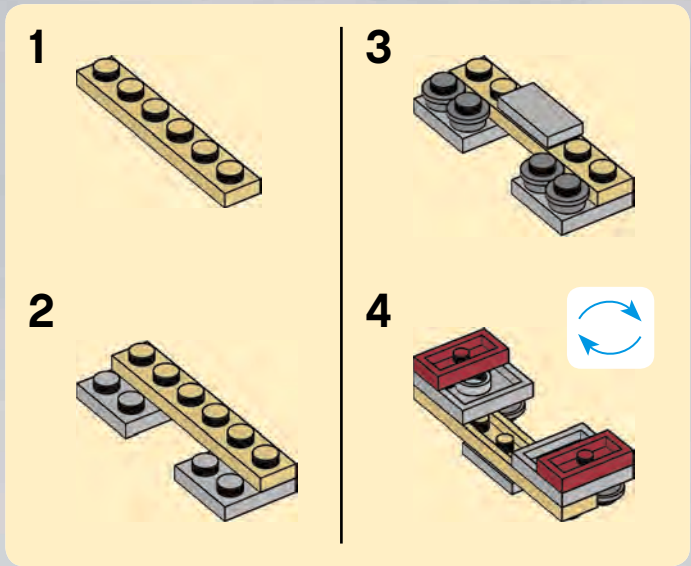



12

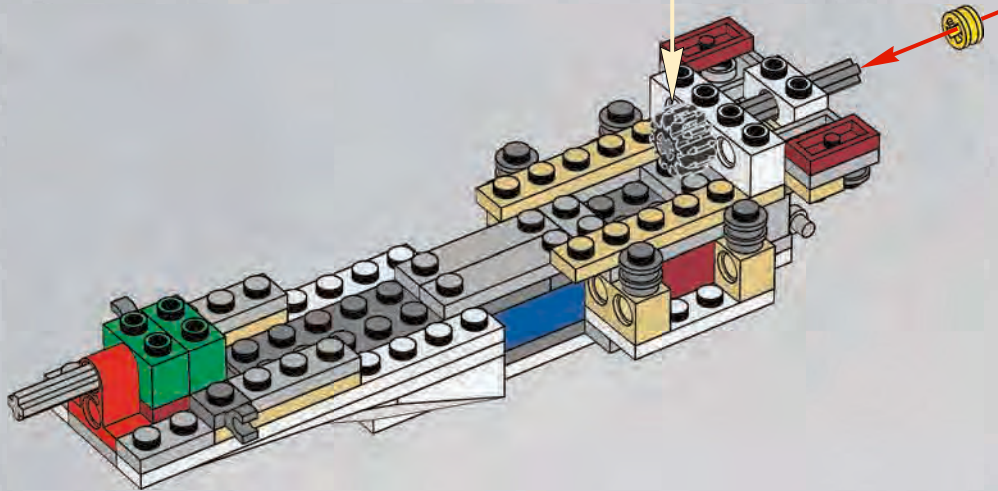
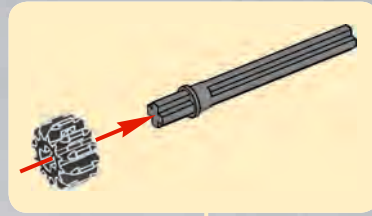

13

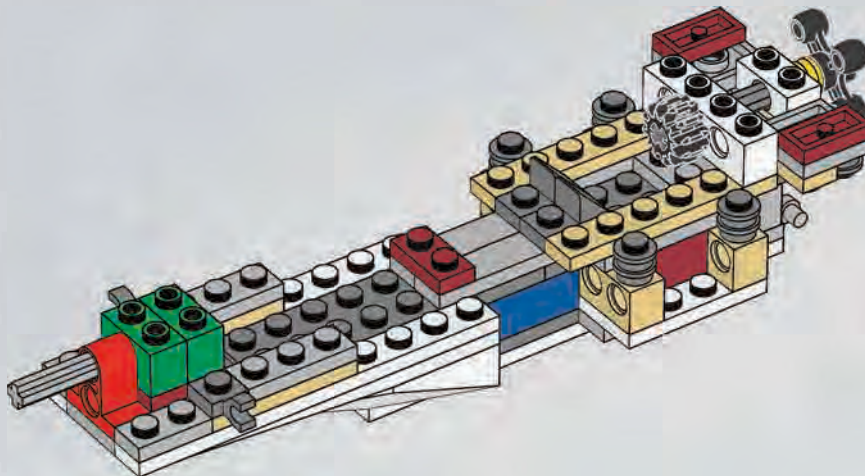



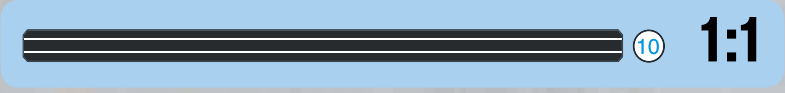
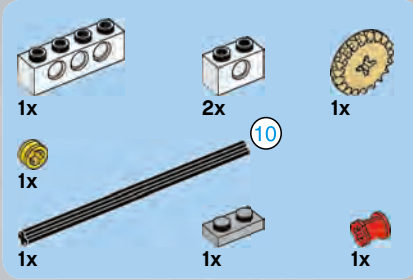

# 14

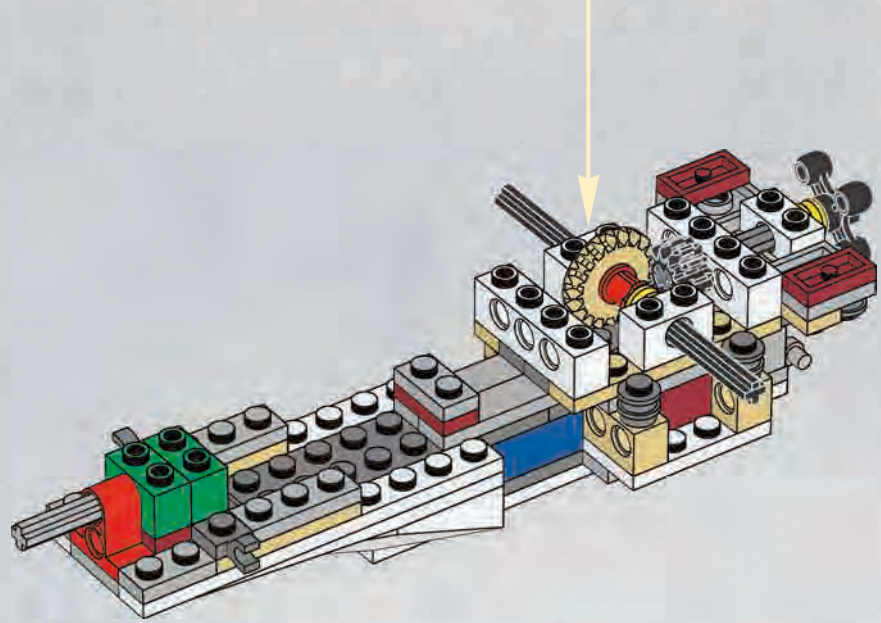
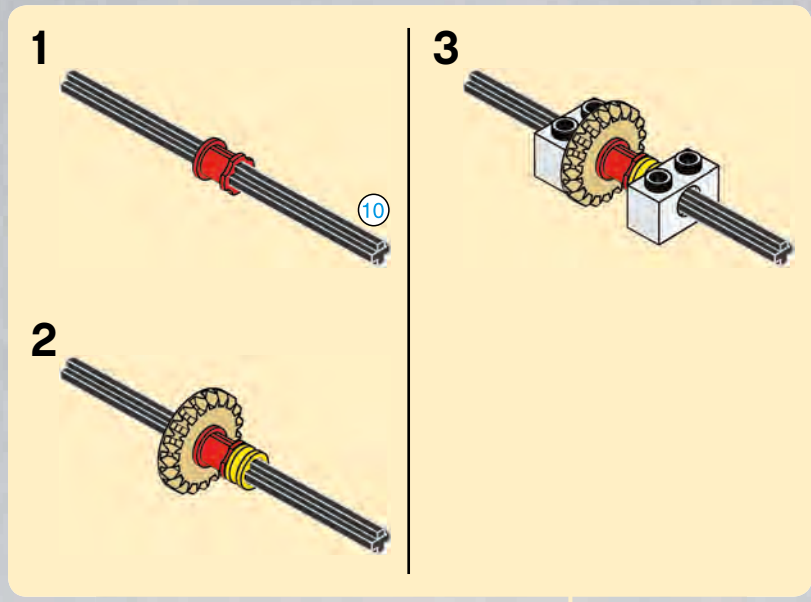



15

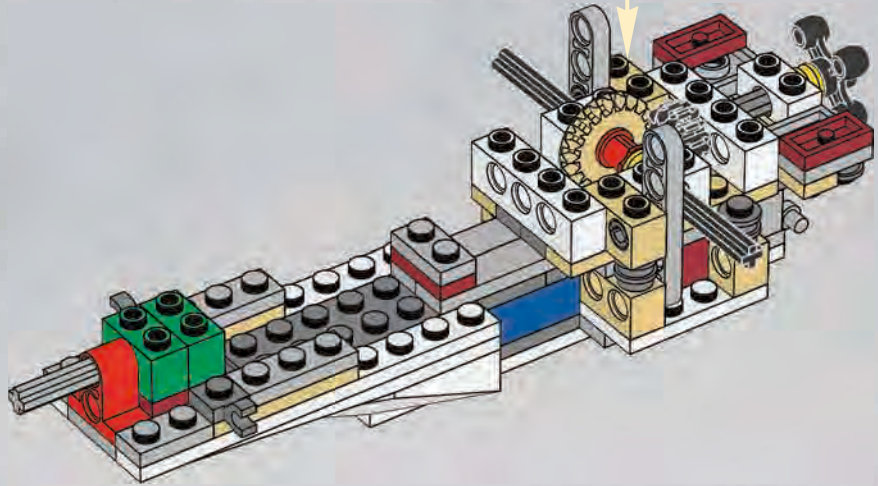
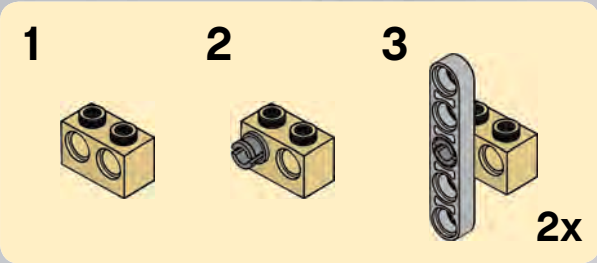

16

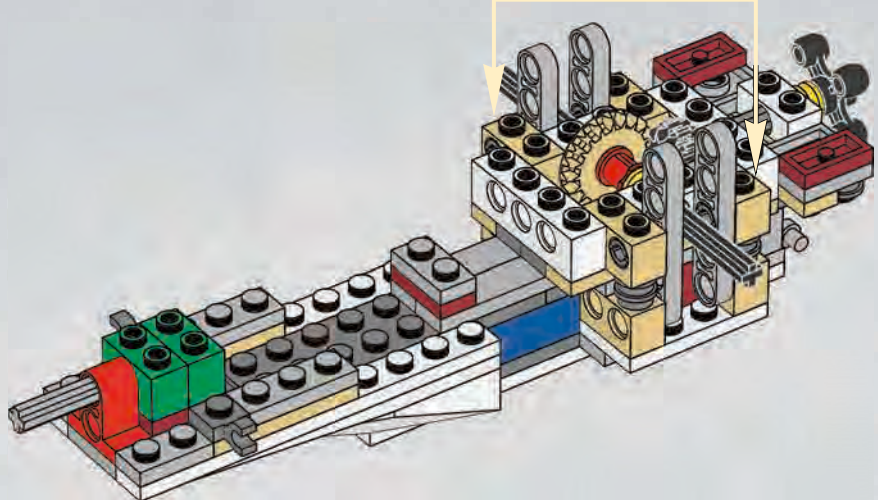
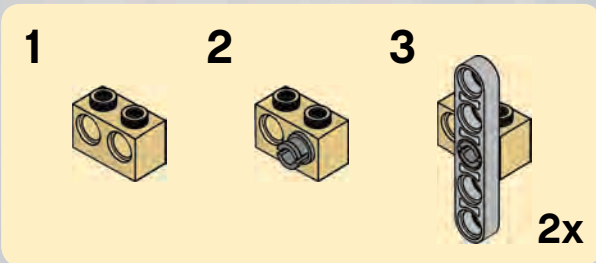





2x

# 17

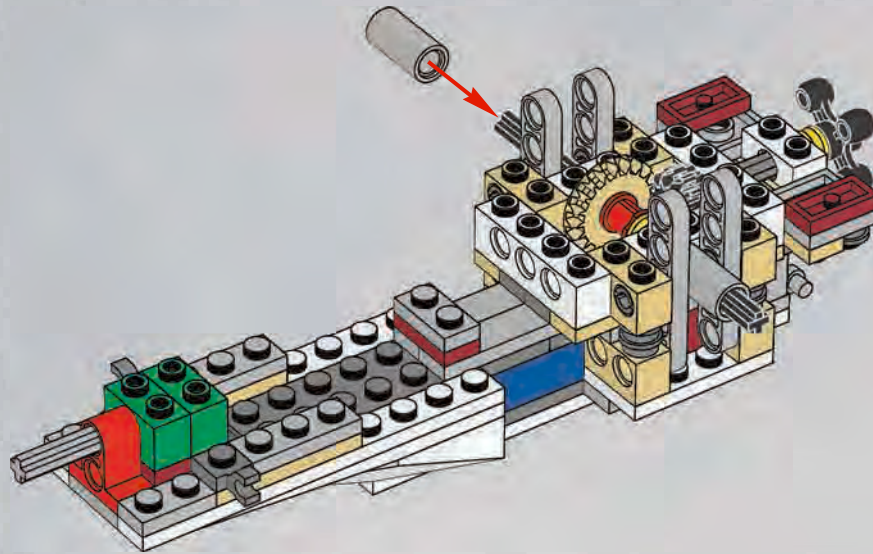

2x



2x



4x

# 18

1

3



2

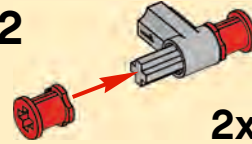

2x

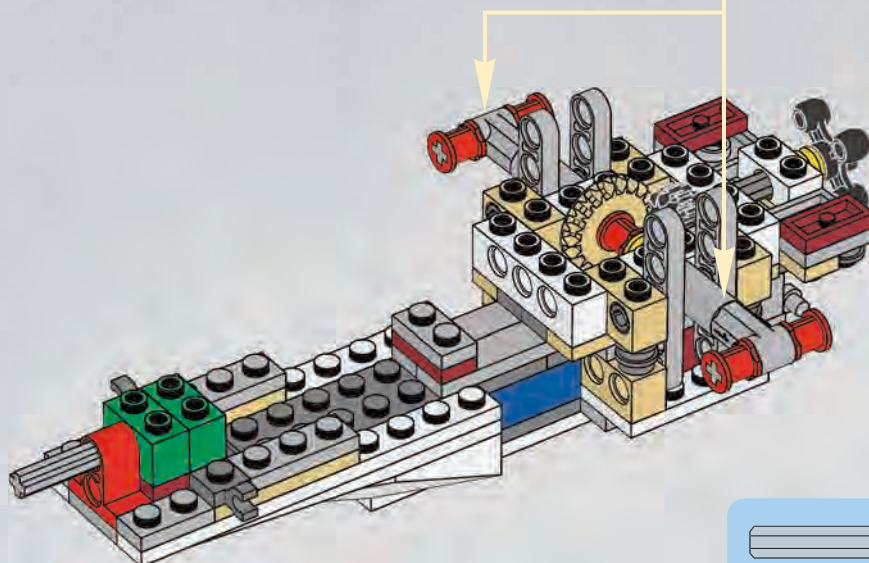

16



2x



1x



1x

# 19

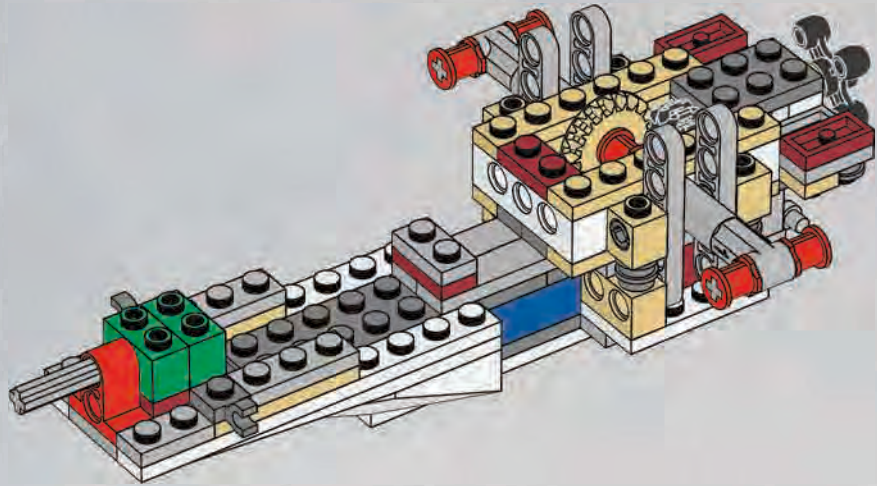

1x



1x

# 20

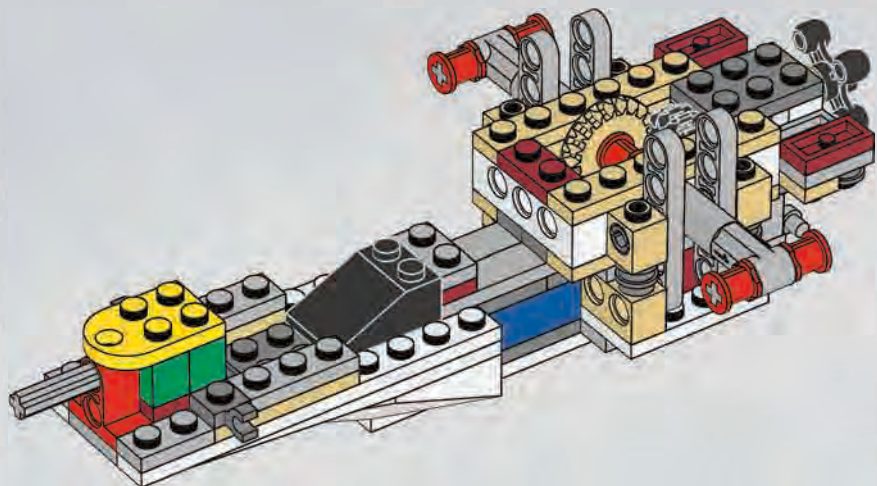





2x



1x

# 21

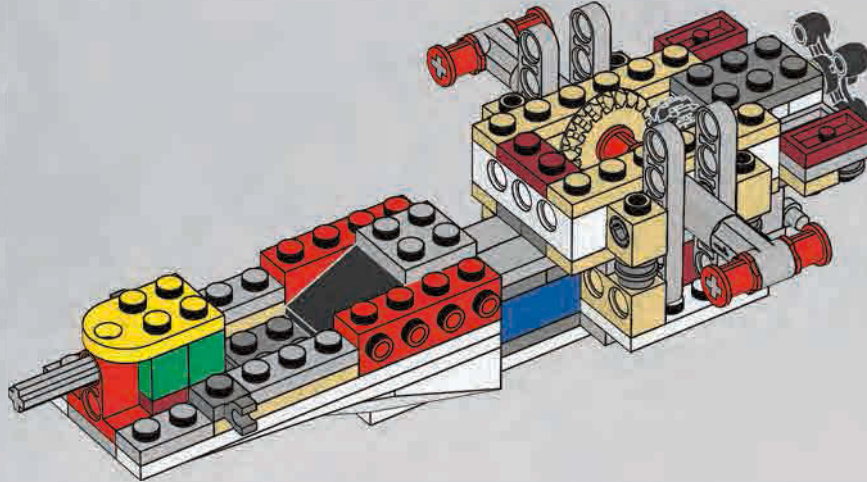

1x



8x



2x

# 22



4x

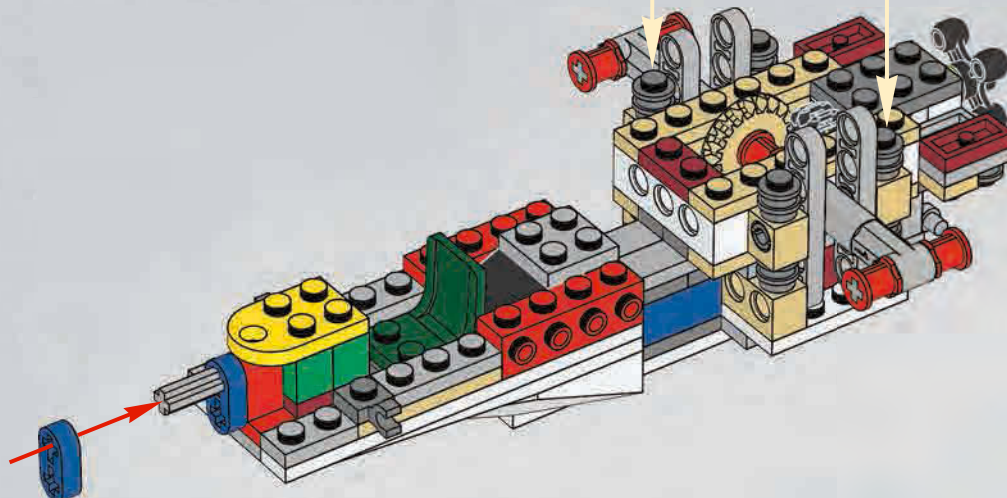

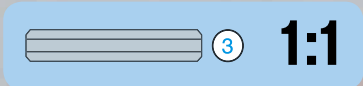
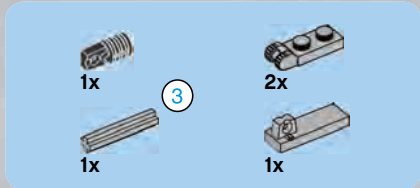

# 23

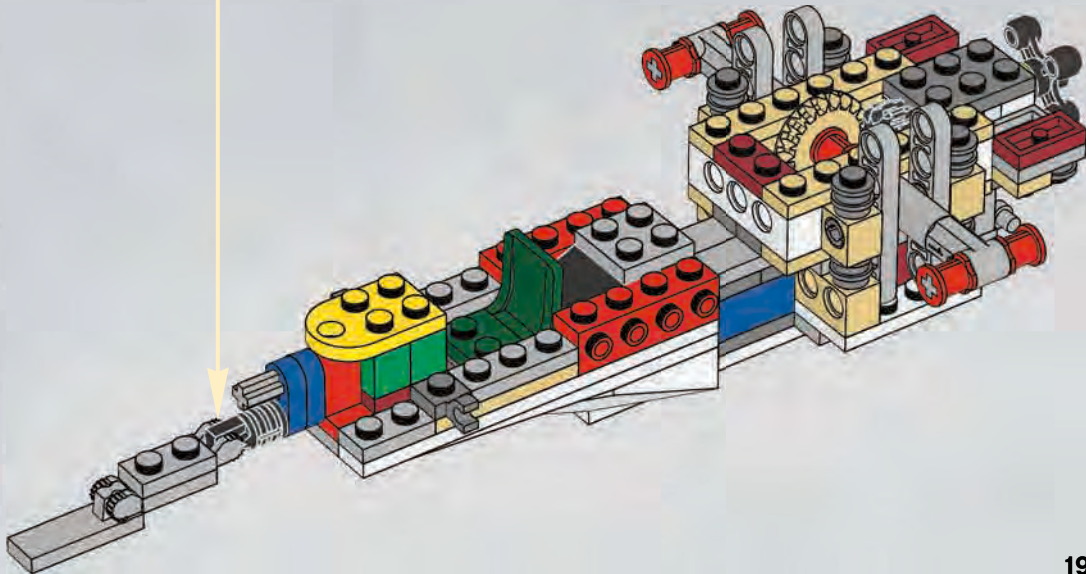
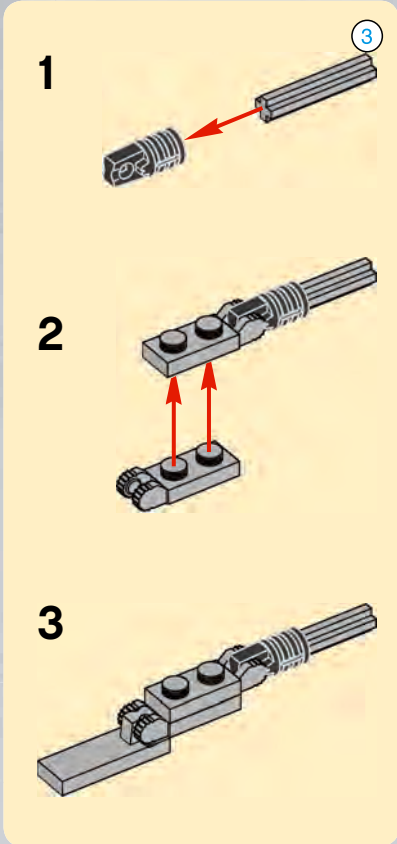



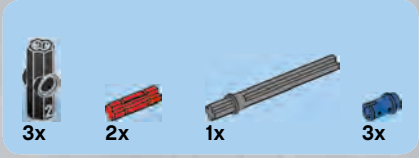

# 24

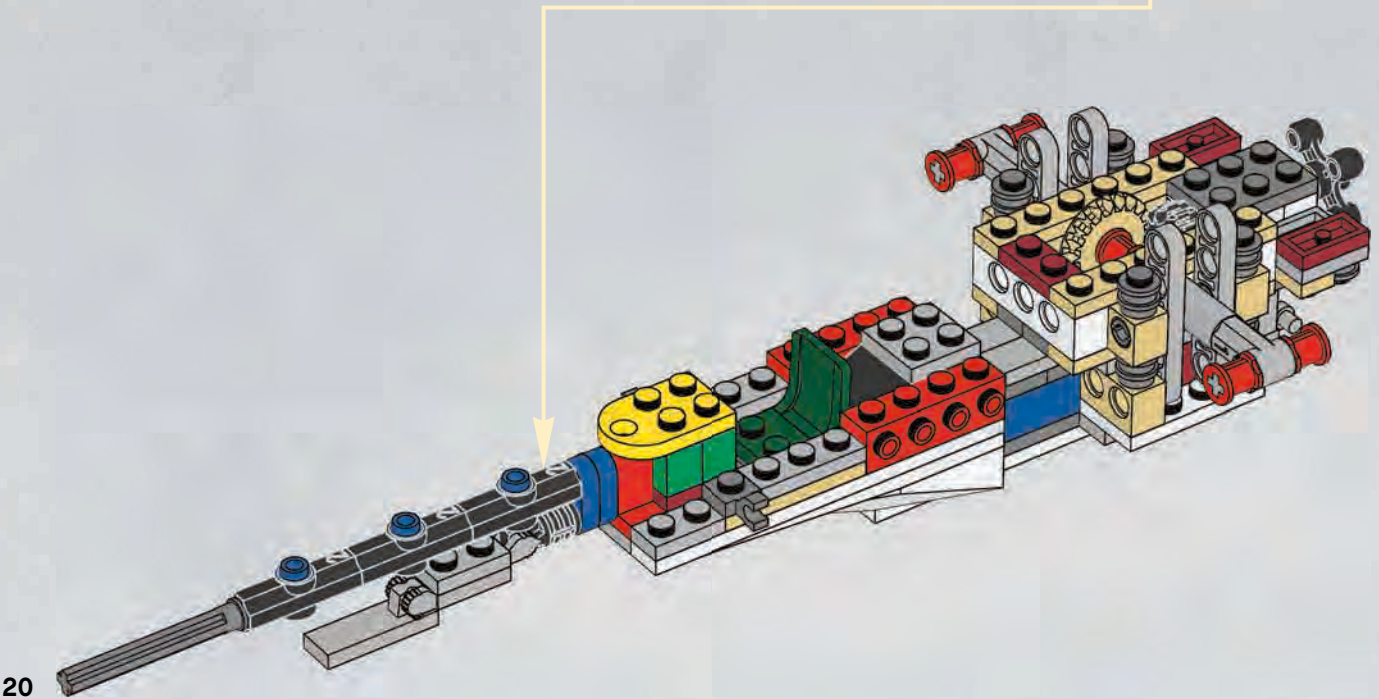

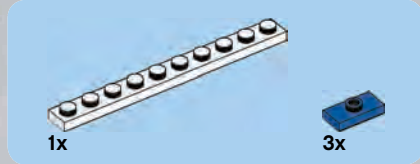

25

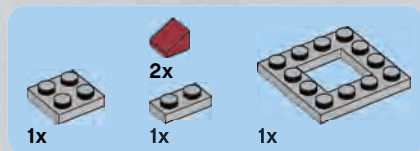
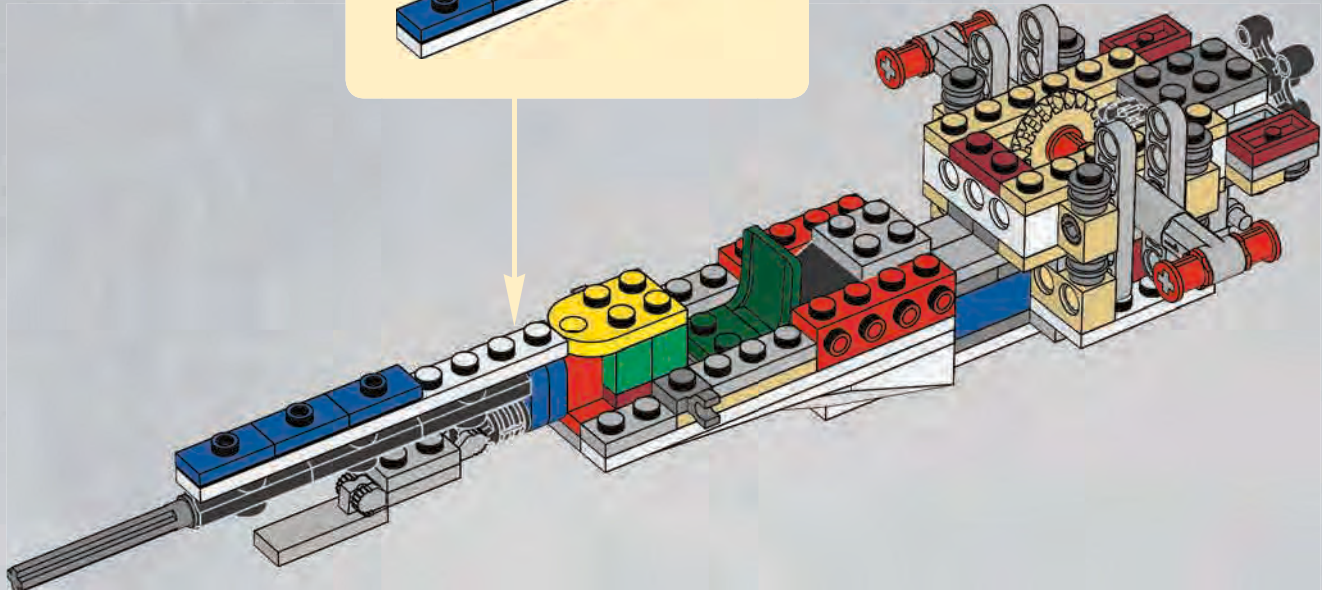
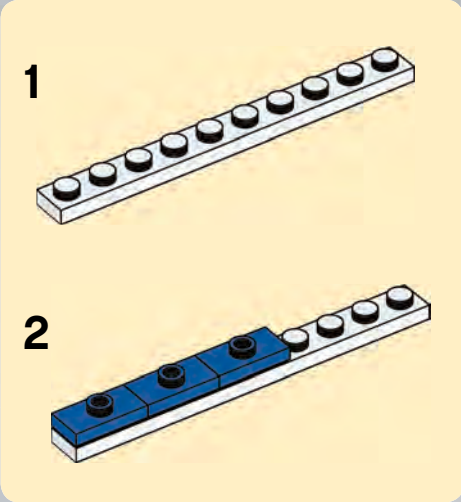

26

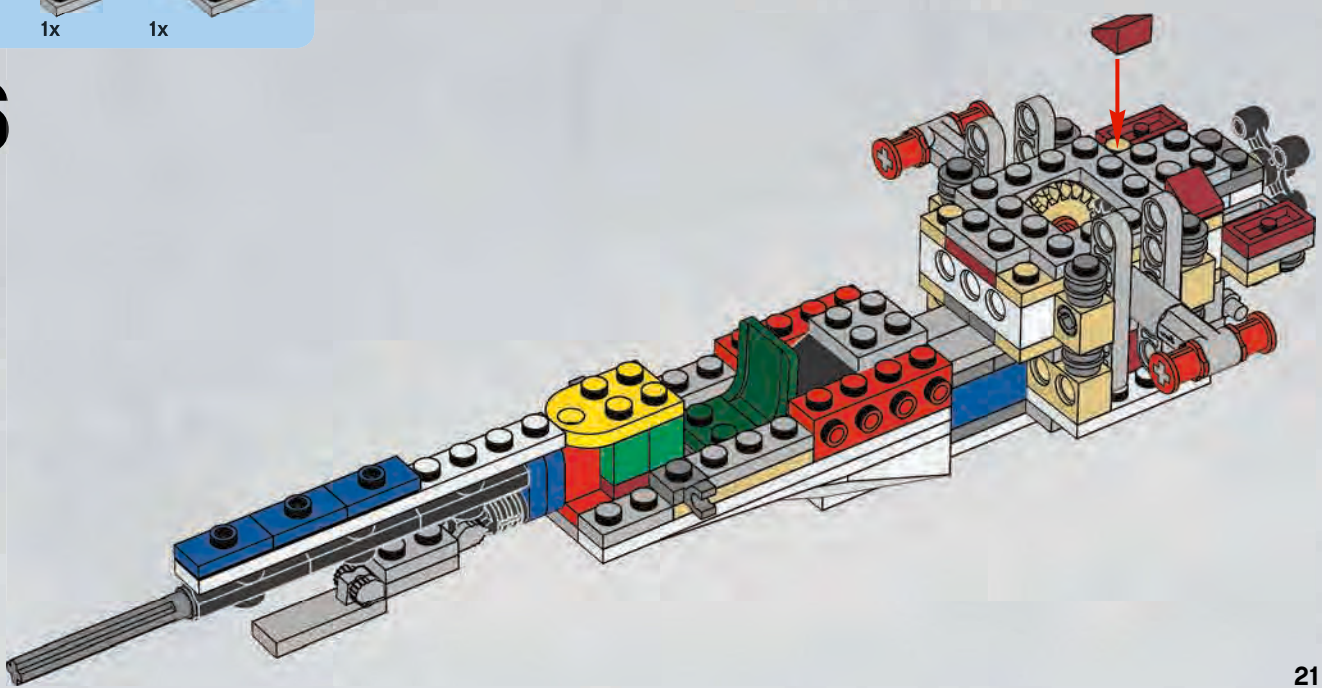



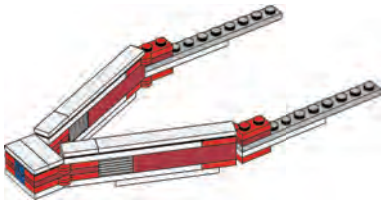
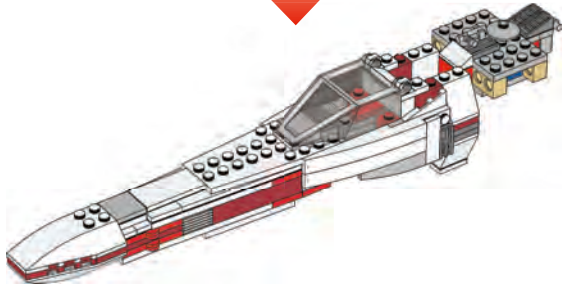

1



2

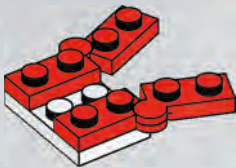

22



3

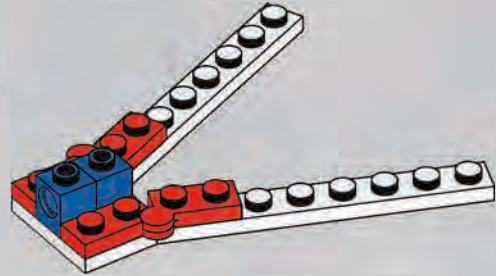

4

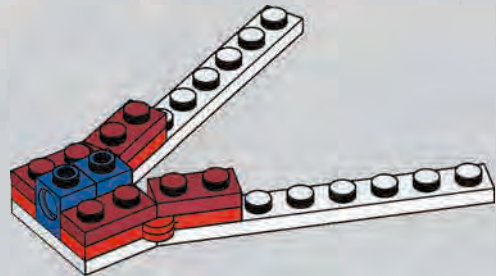

5

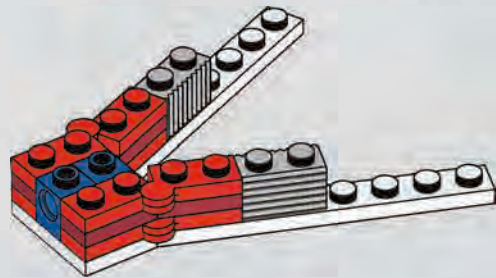



6

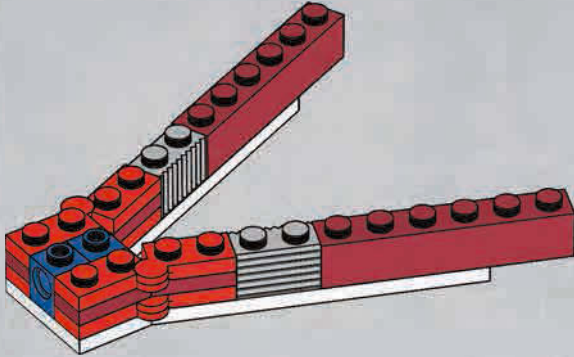

7

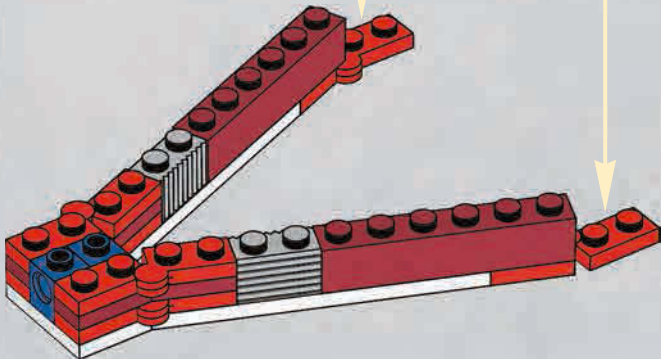

8

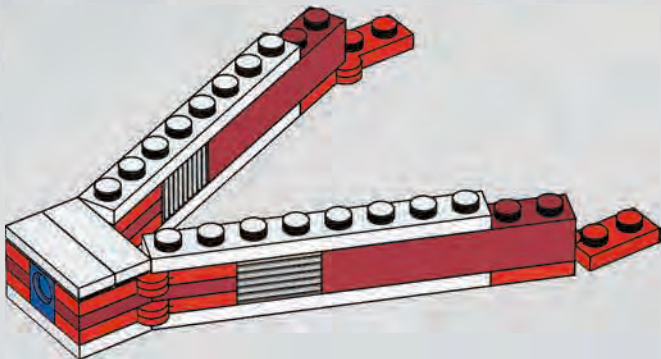



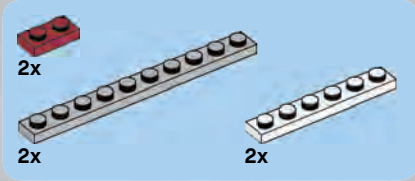

9

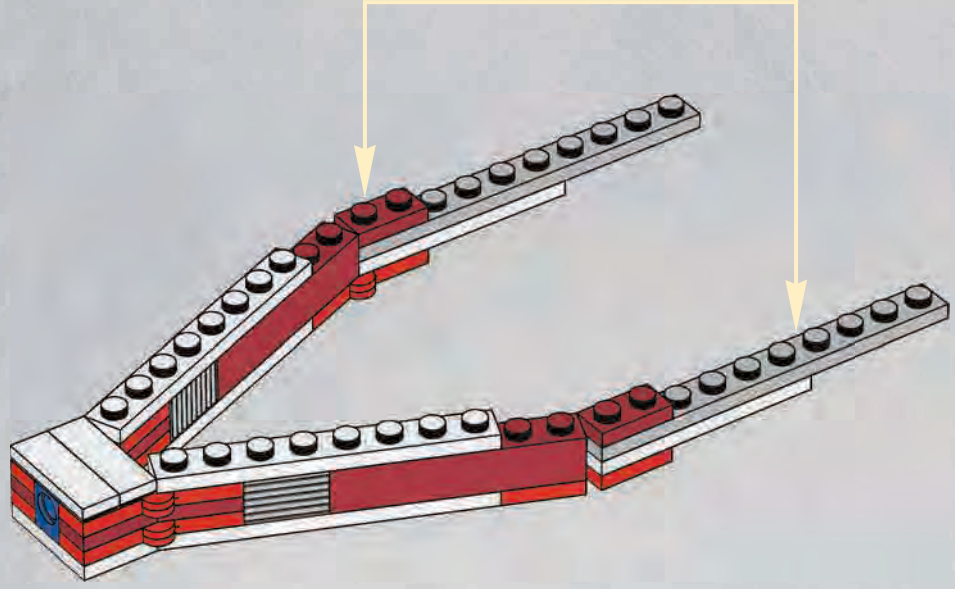
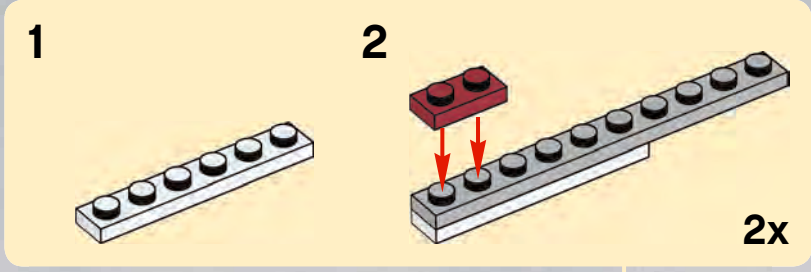

10

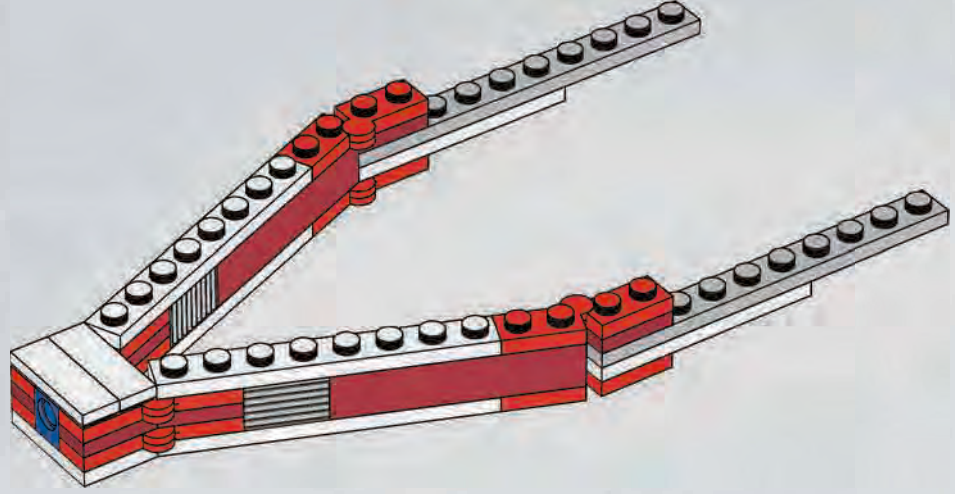



2x

# 11

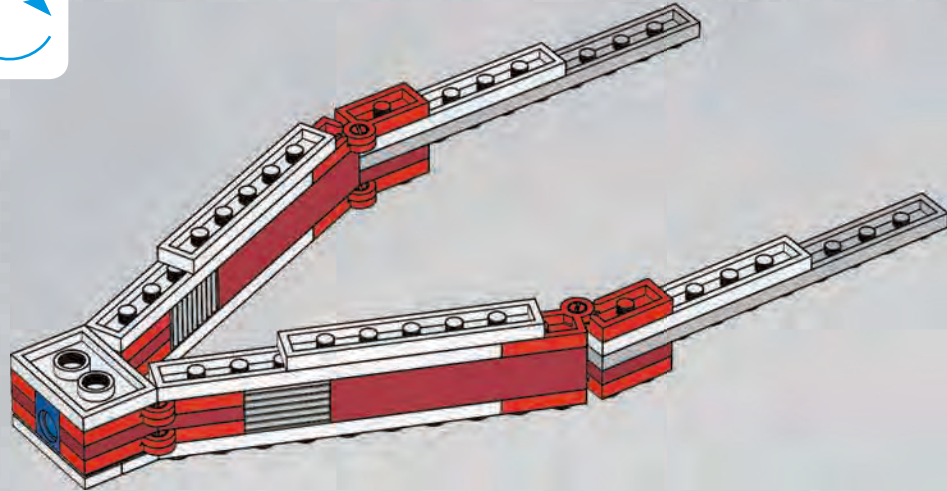

2x



2x

# 12

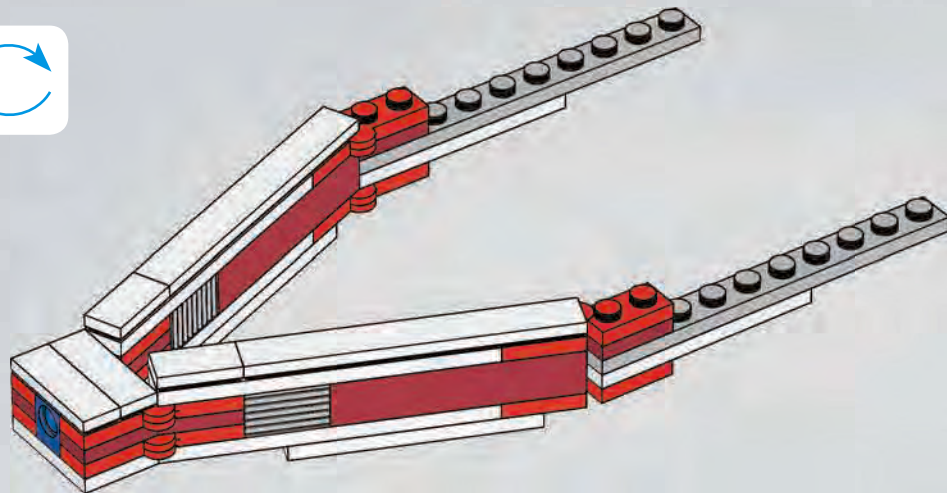



13

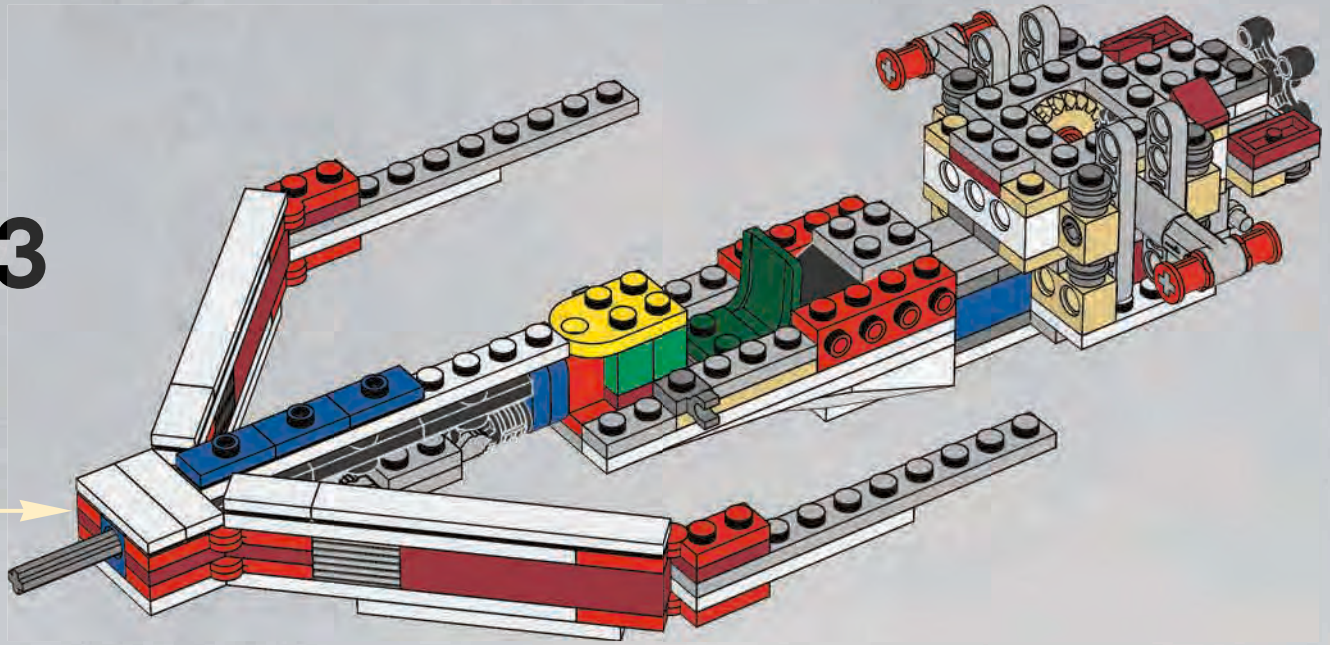

14

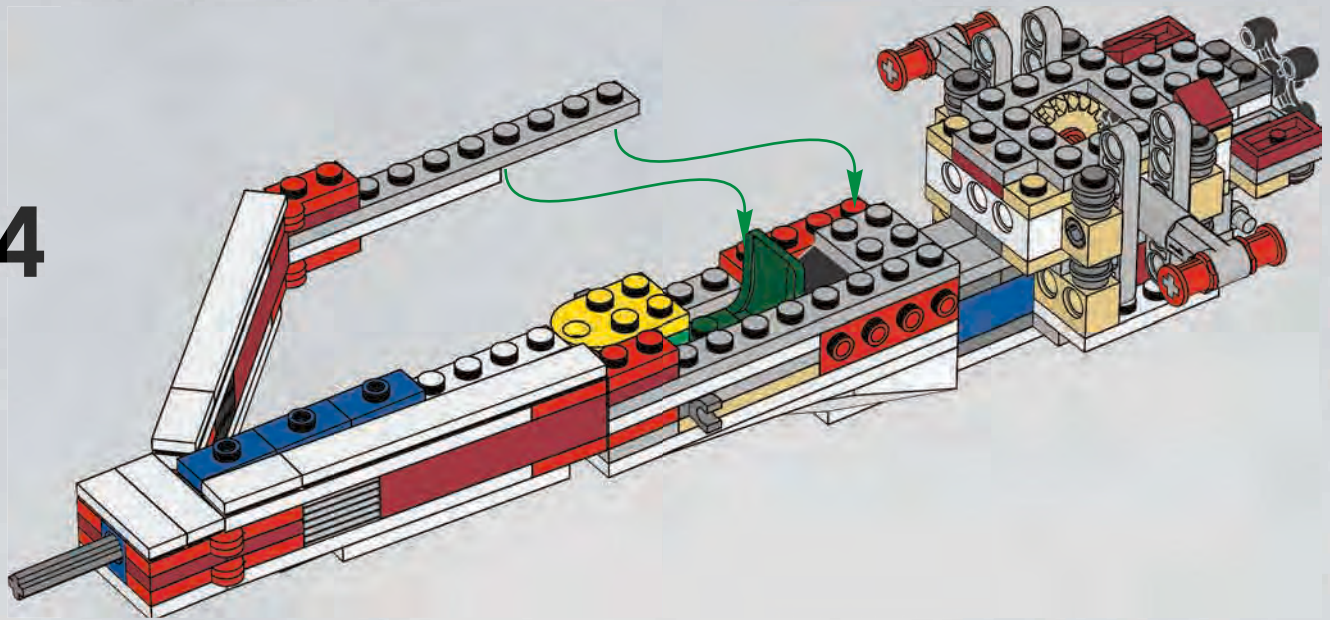

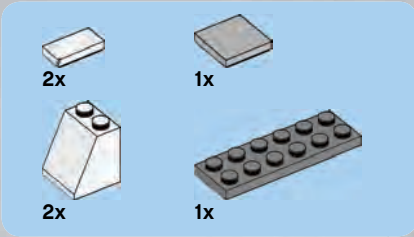

# 15

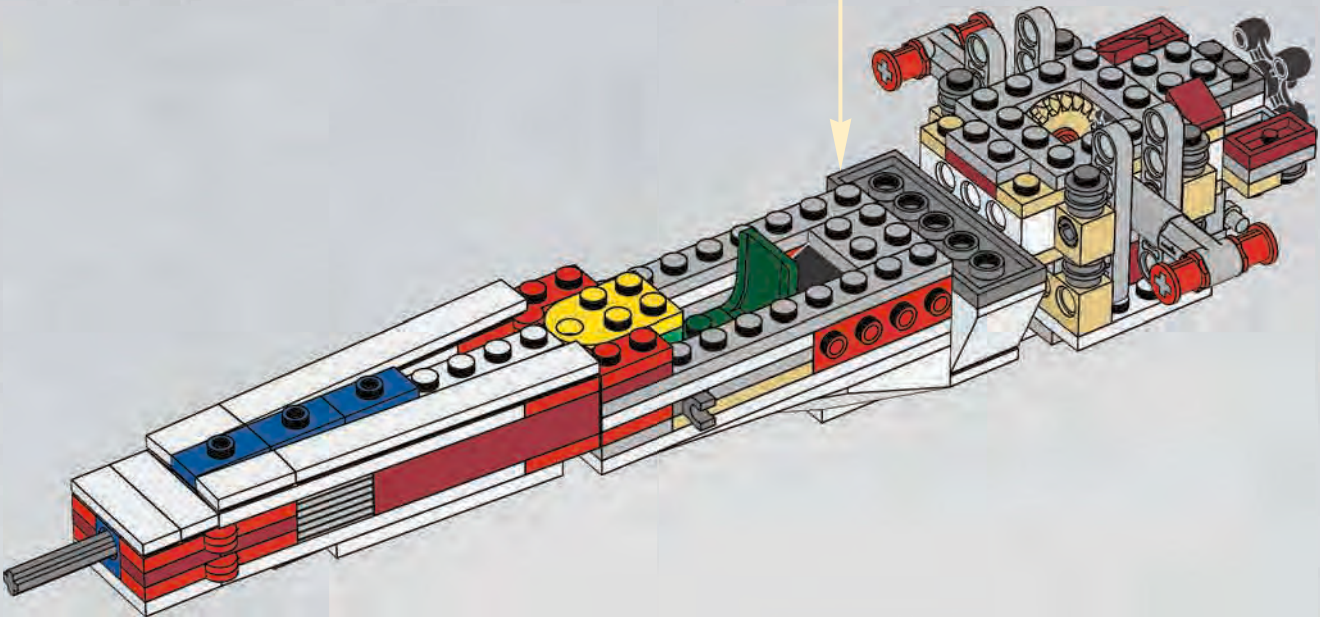
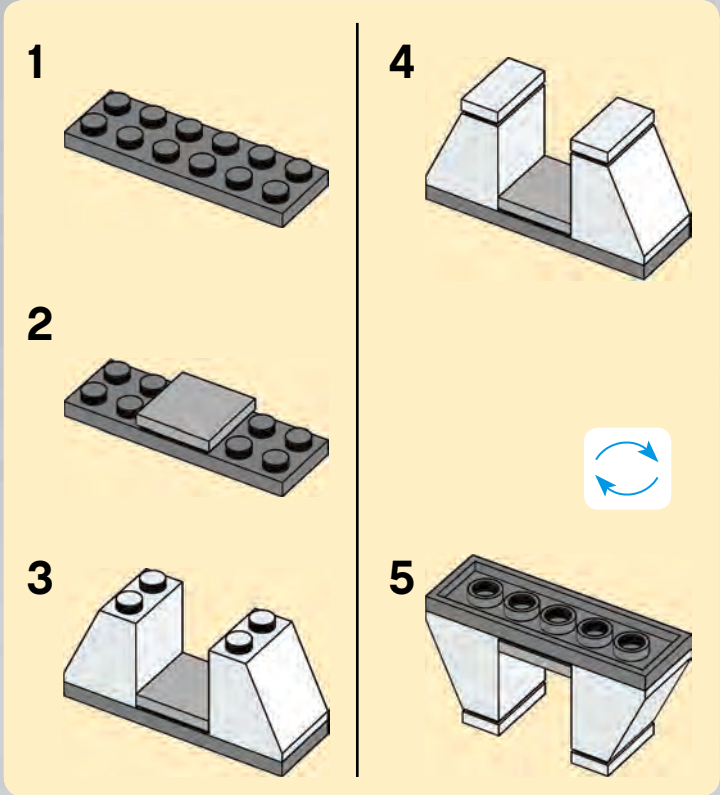





# 16

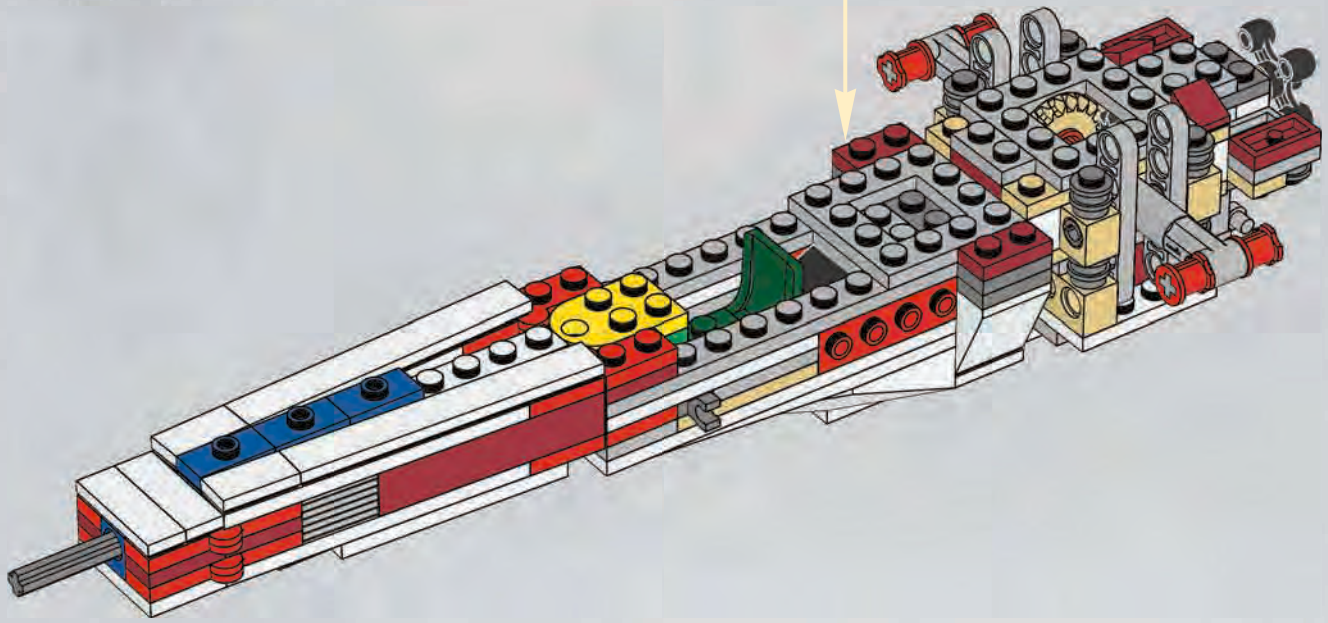
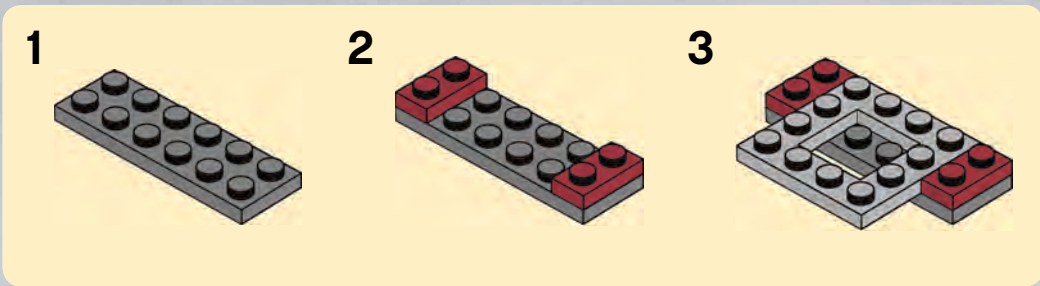



2x



2x

# 17

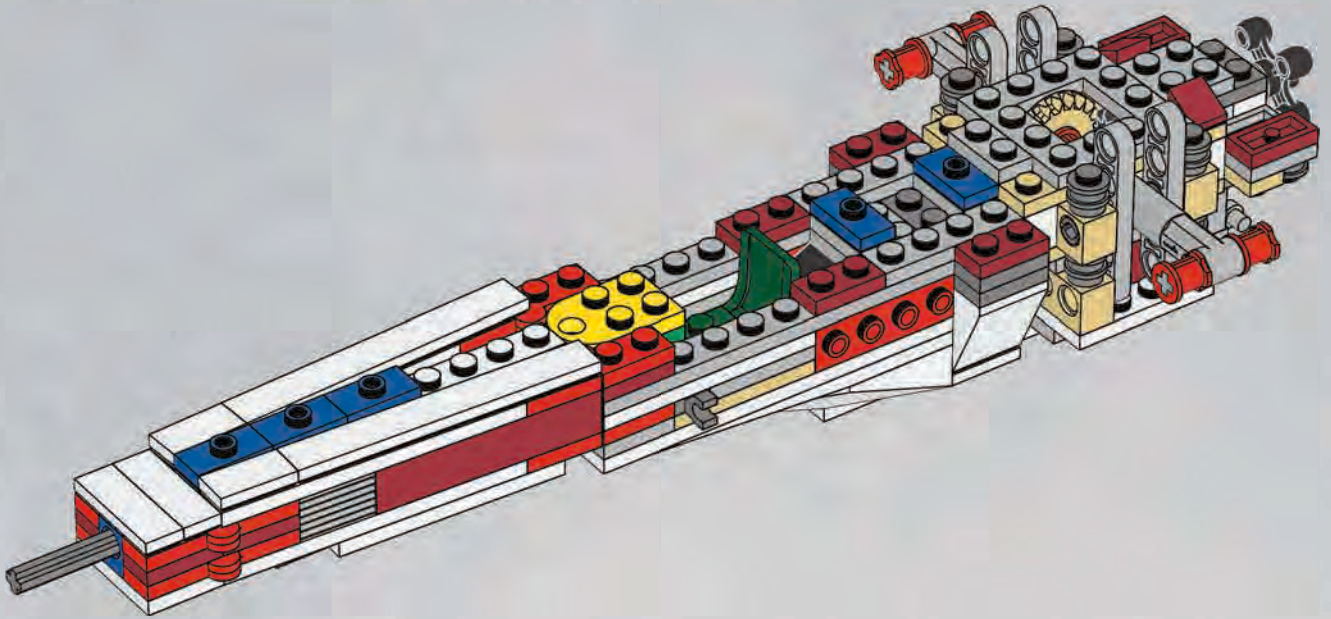

1x



1x



2x

# 18

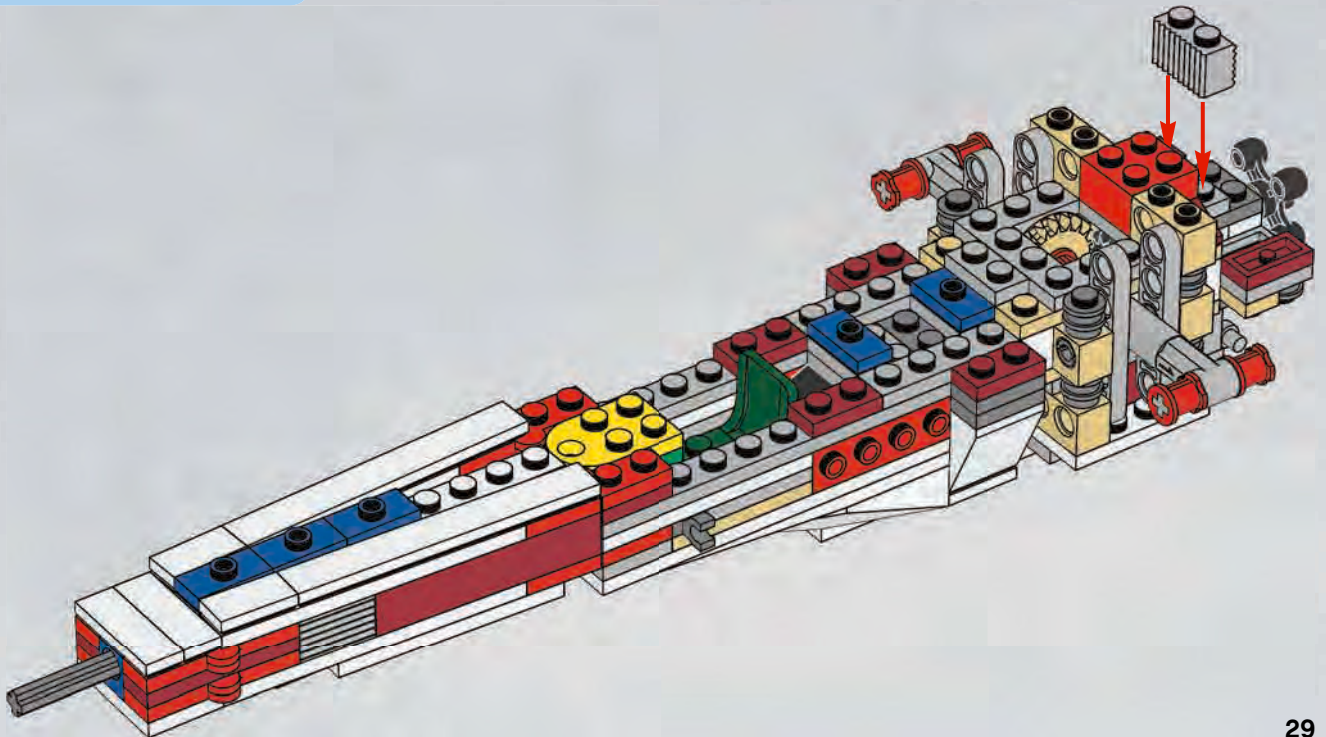



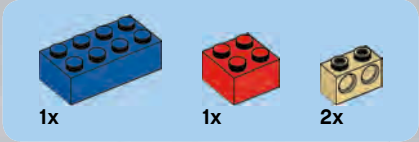

# 19

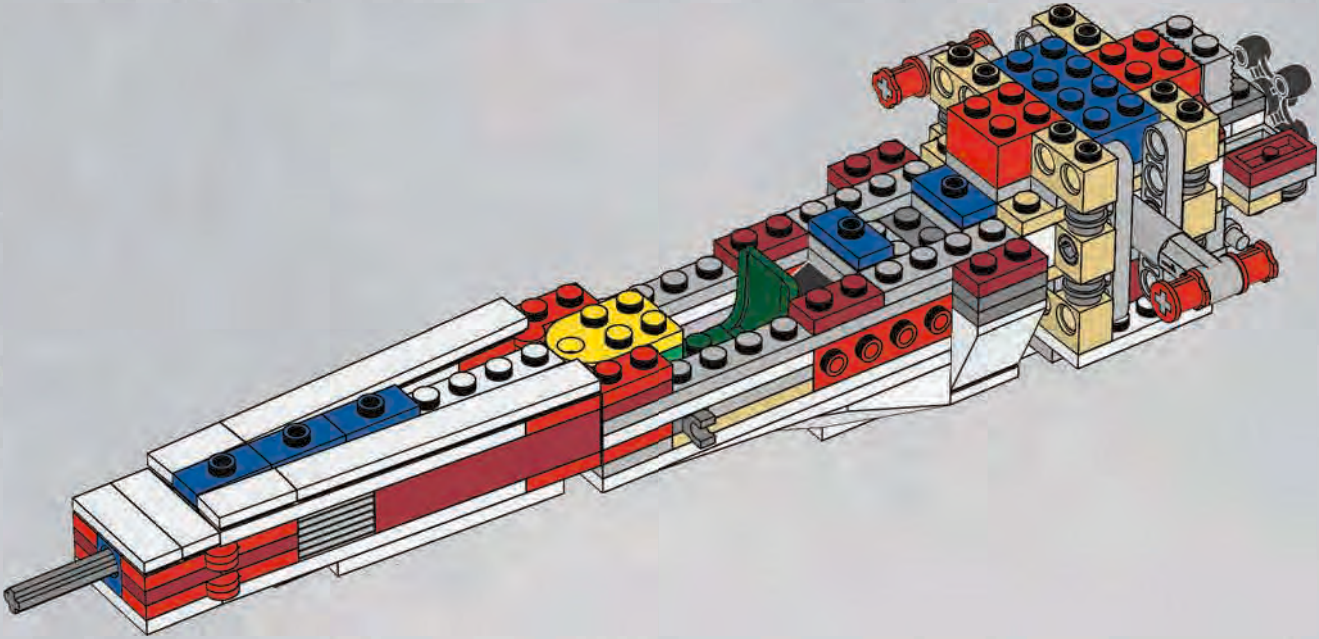

# 20

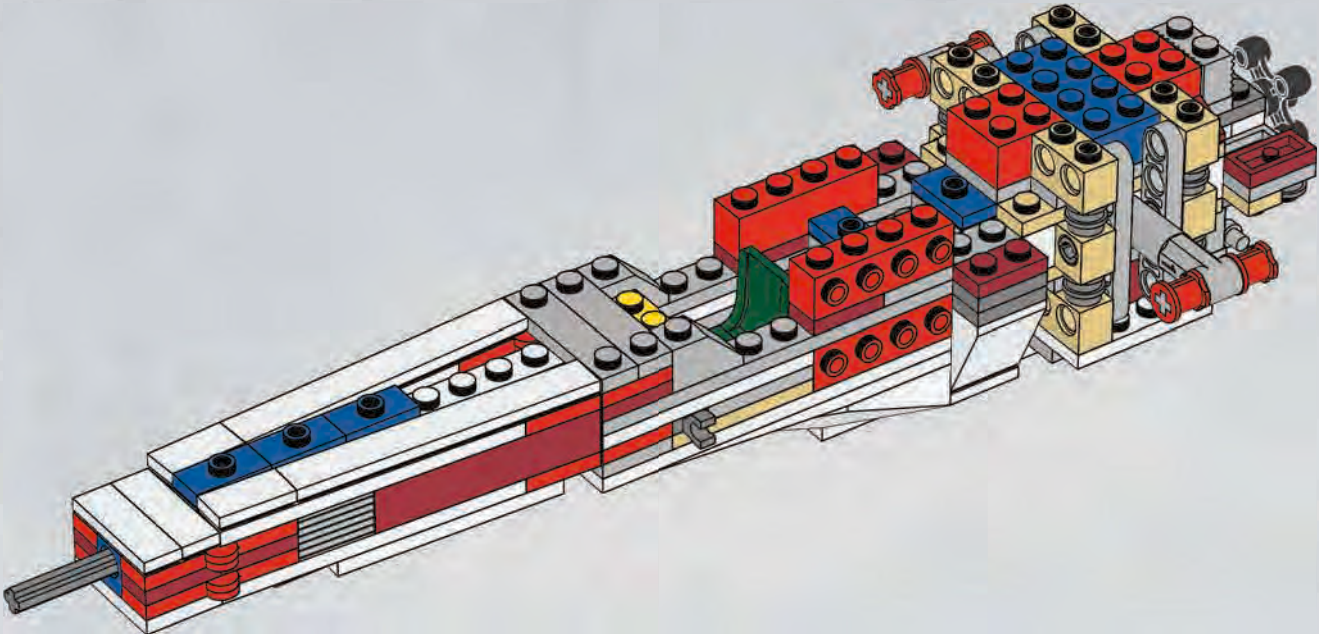



21

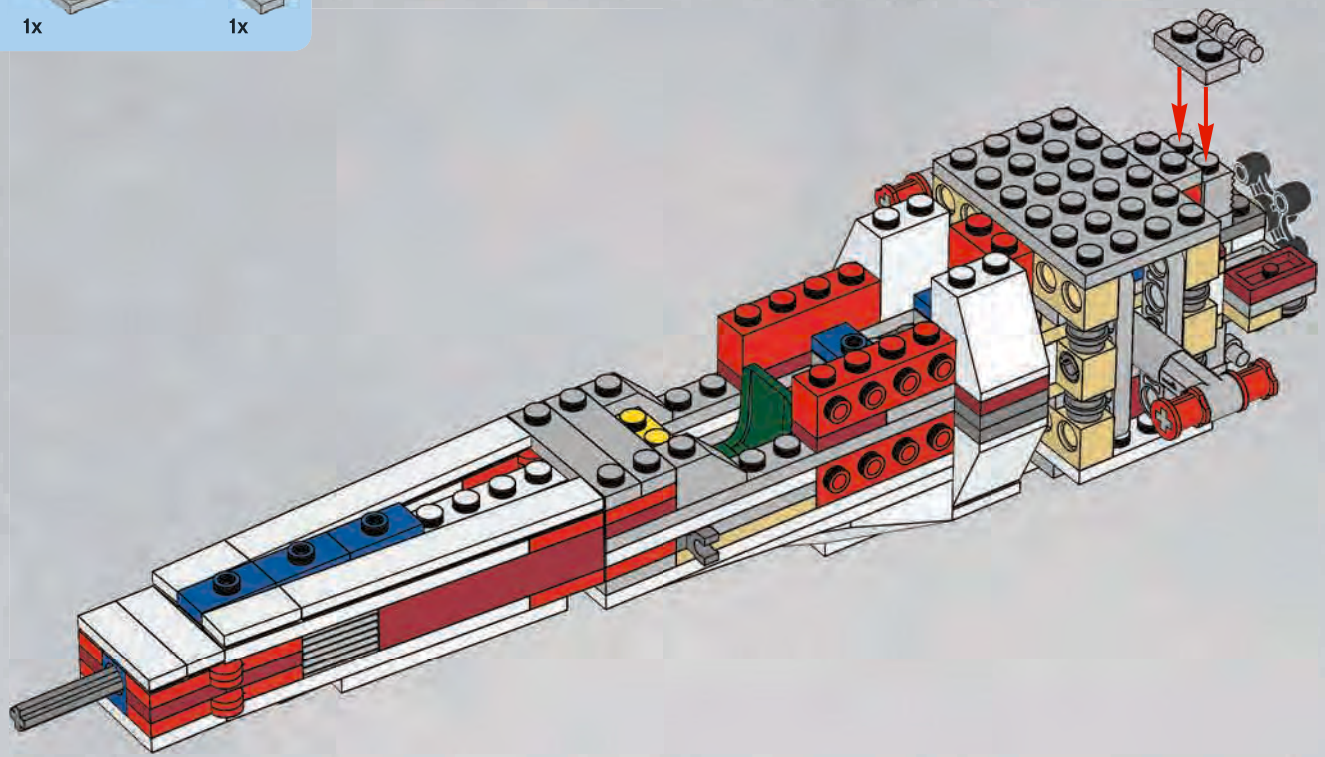

22

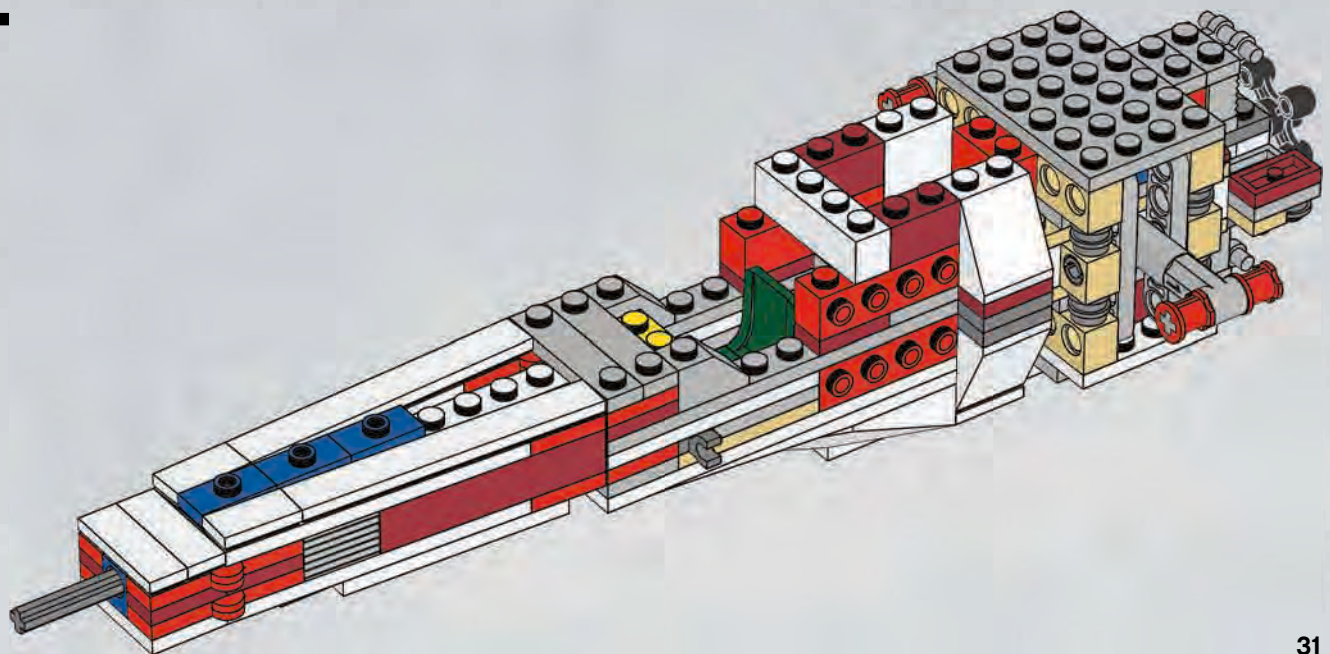



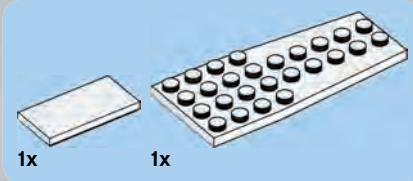

# 23

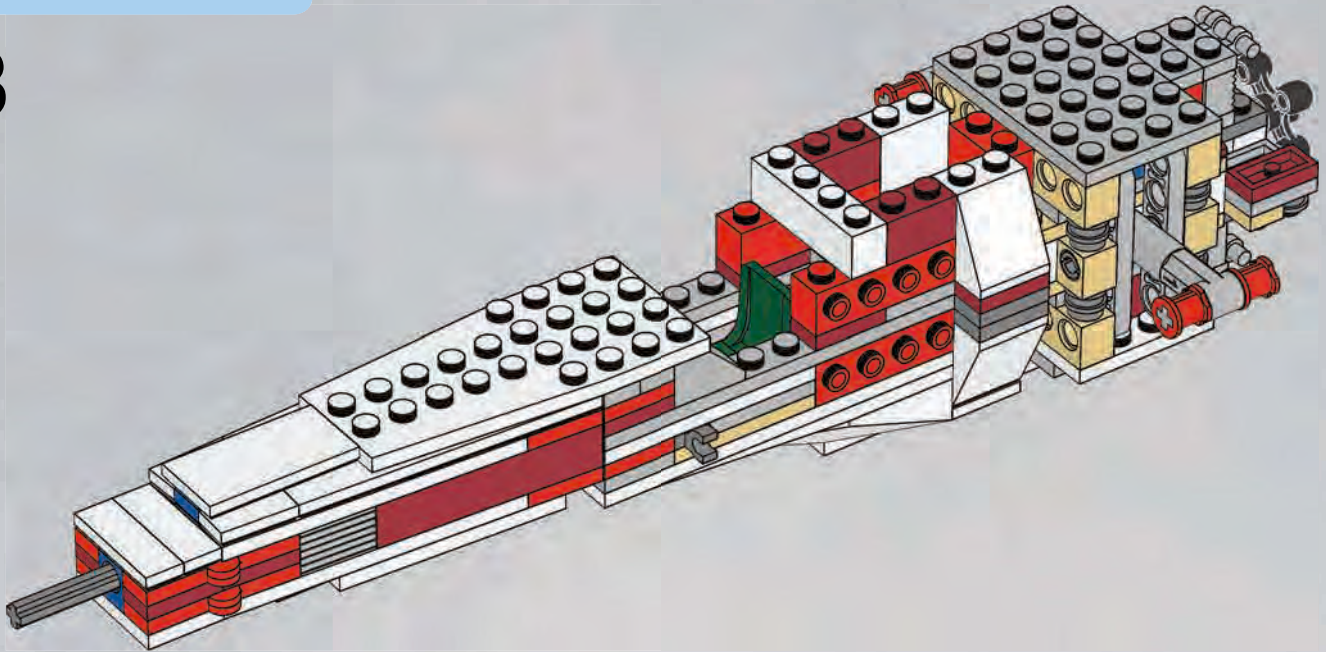

# 24

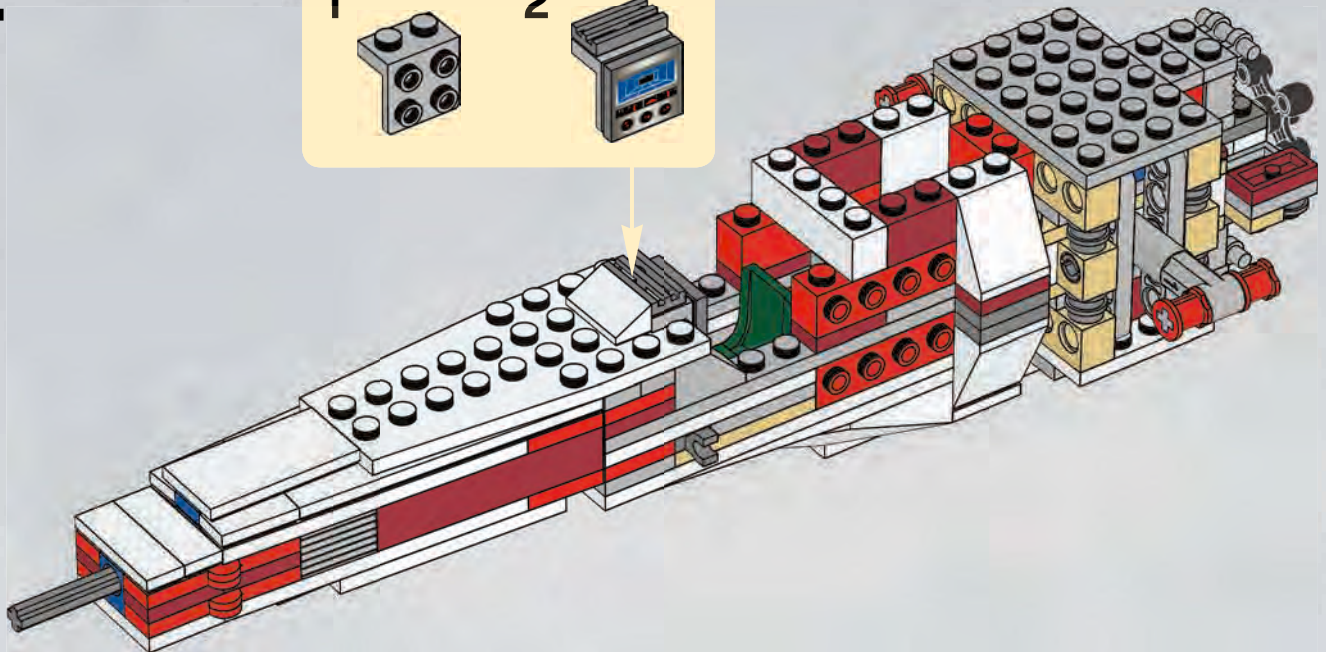
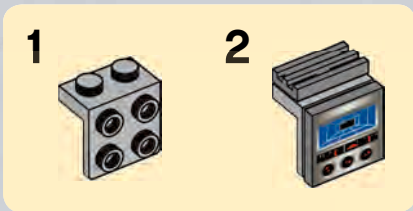

32



25

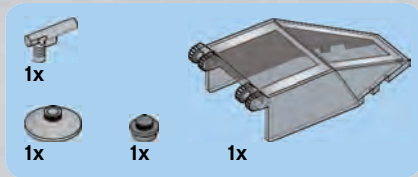
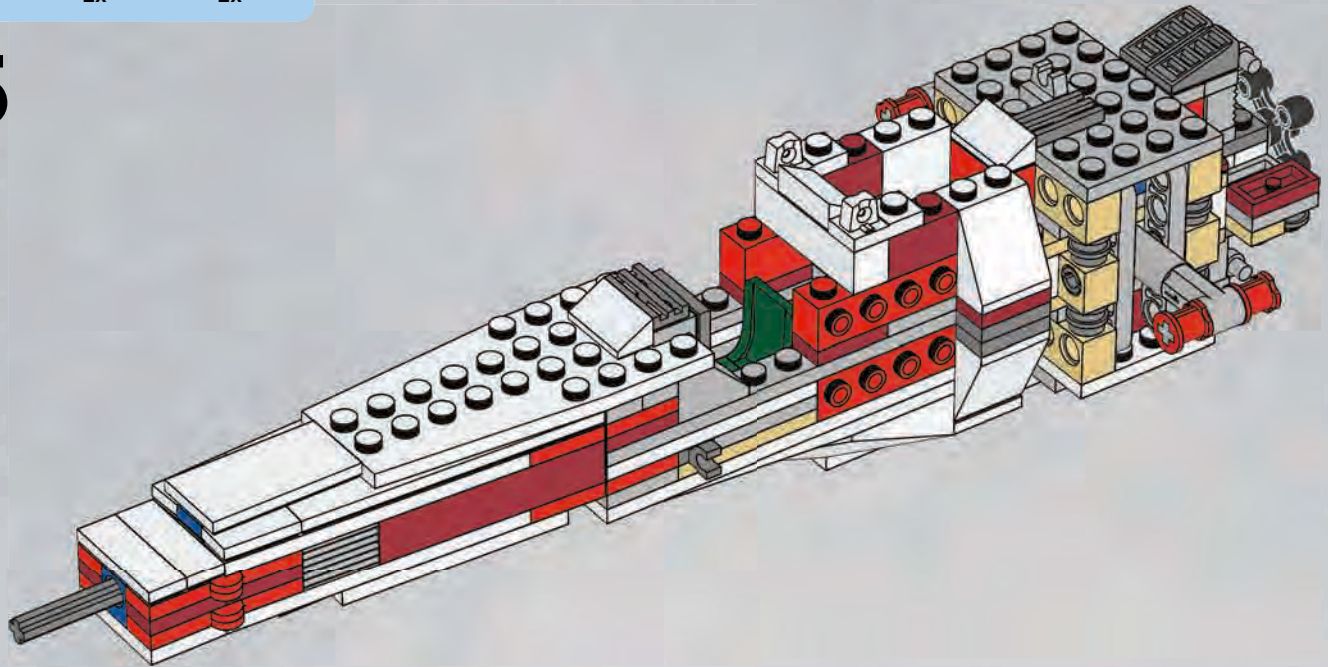

26

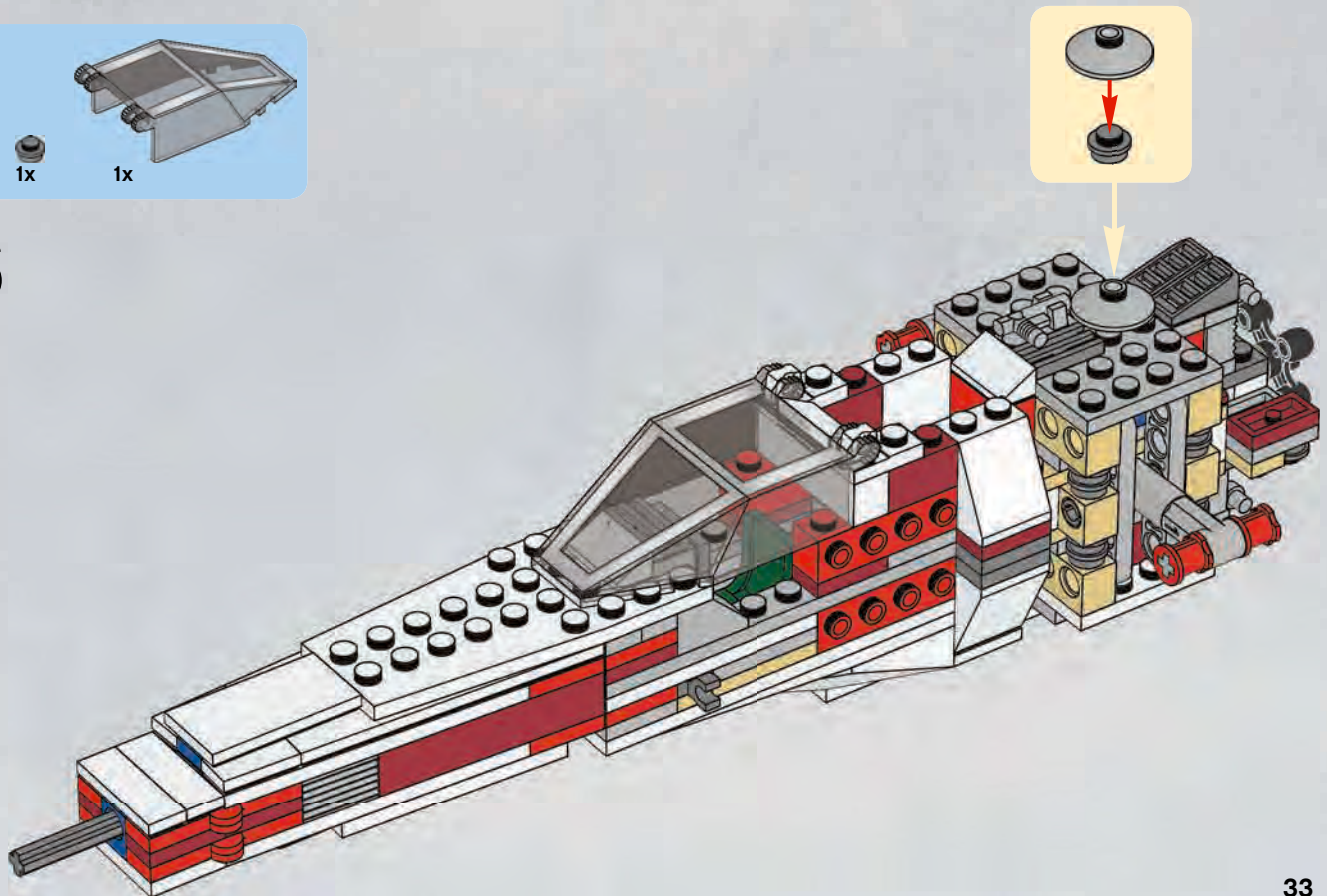



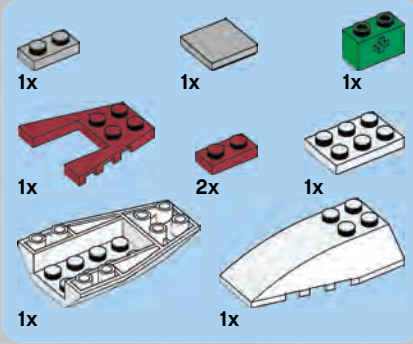

# 27

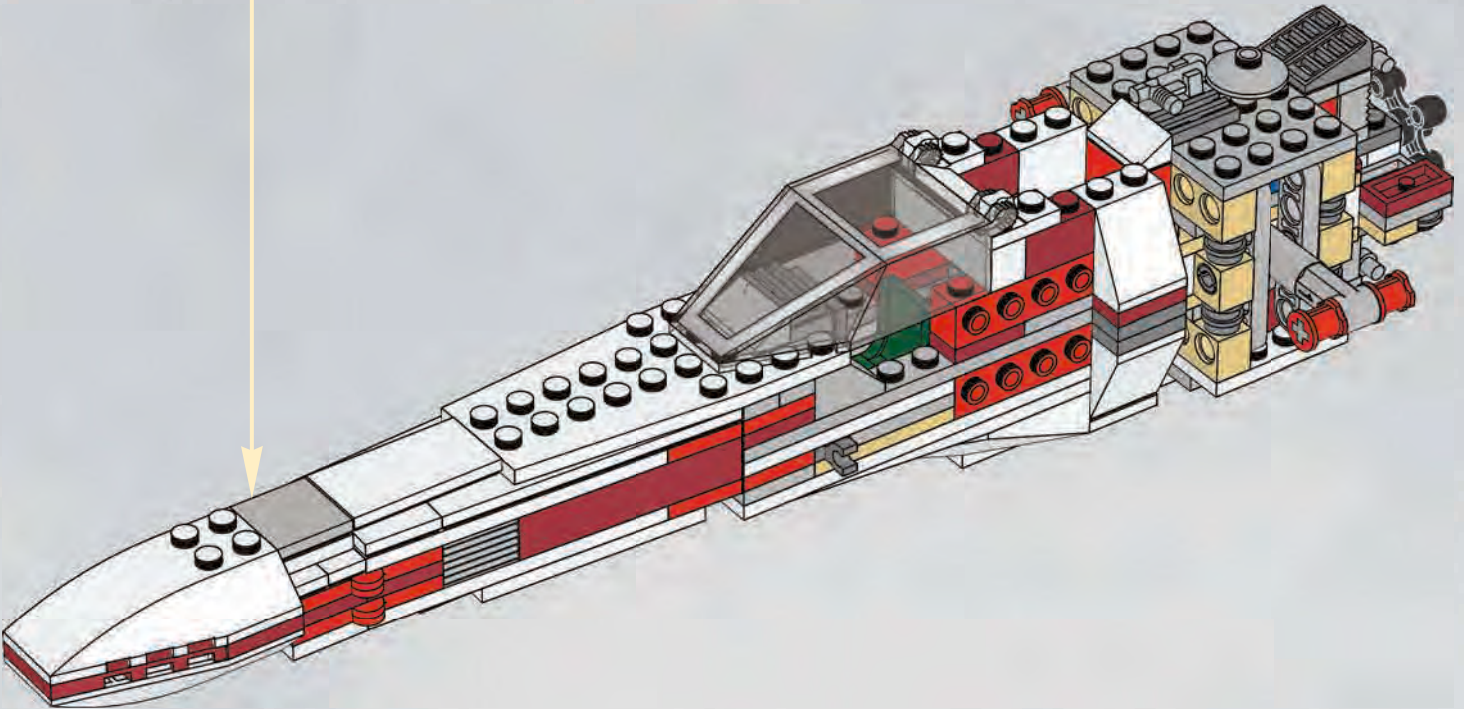
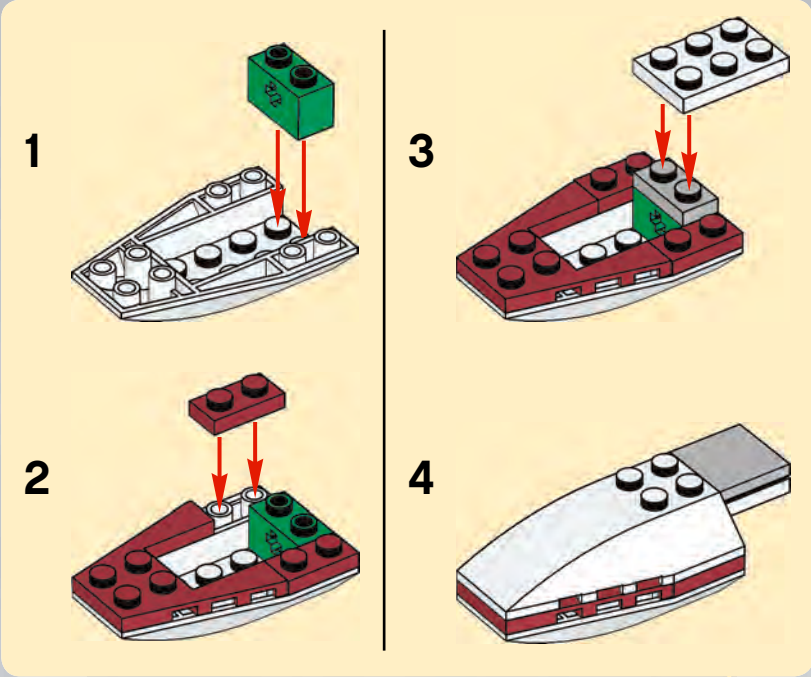

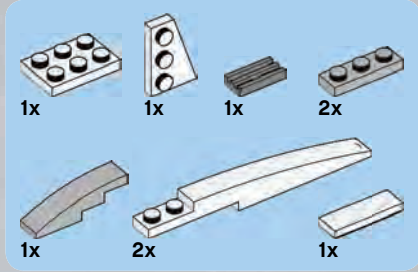

# 28

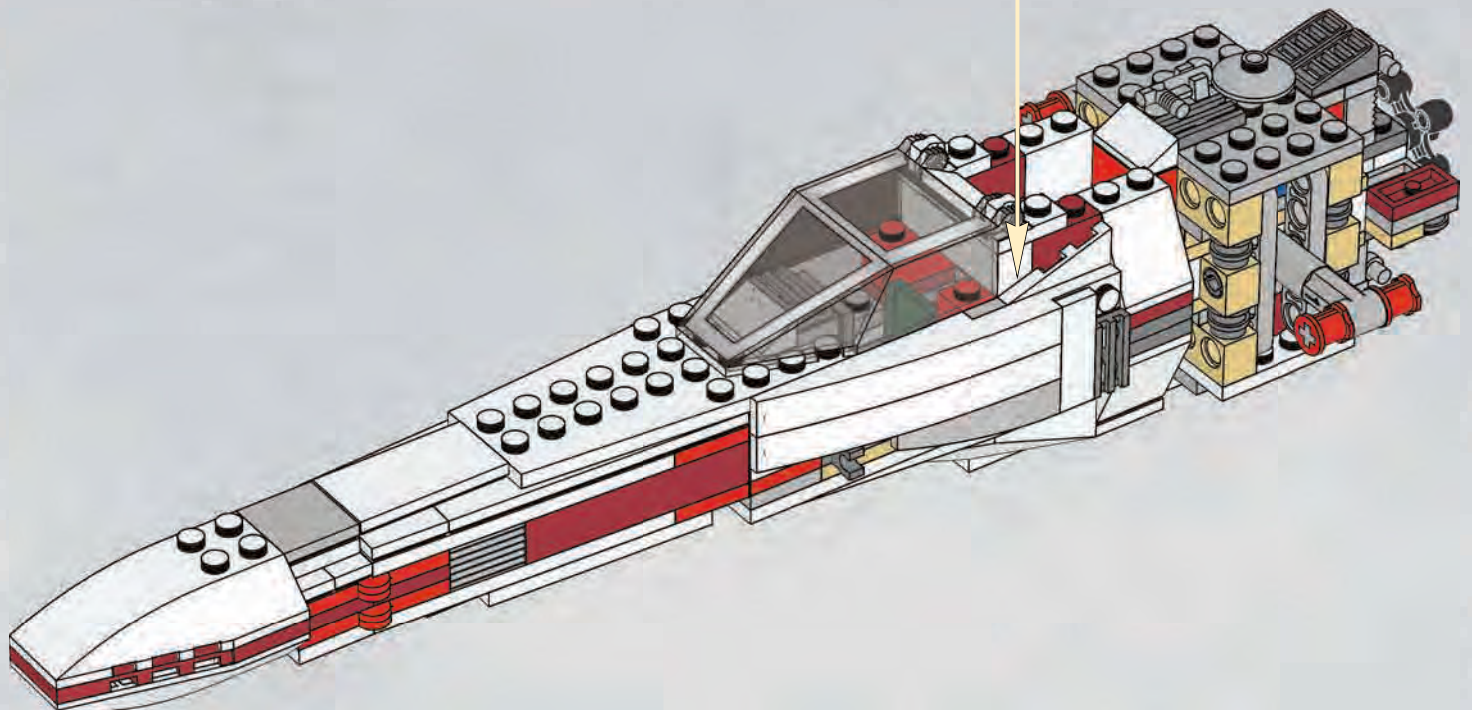
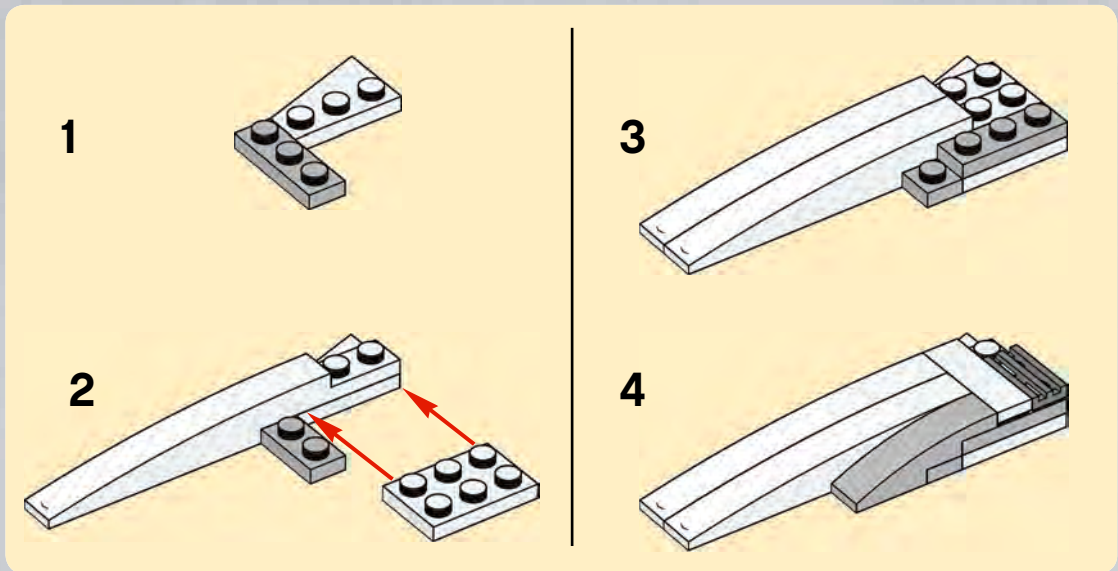



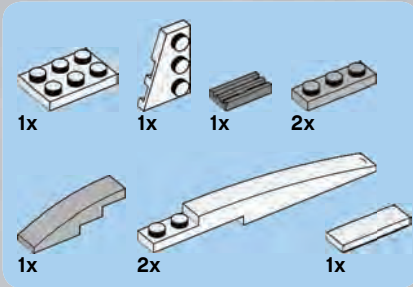

# 29

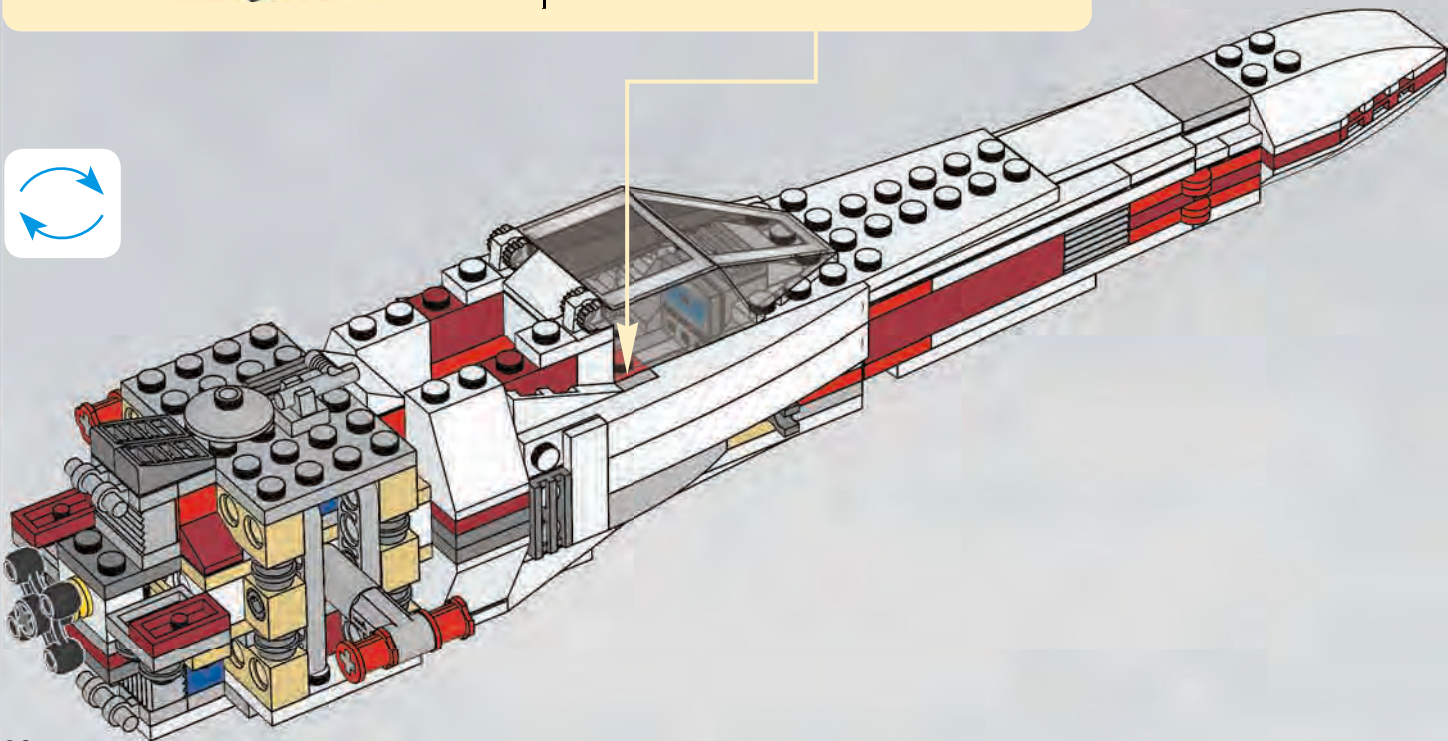
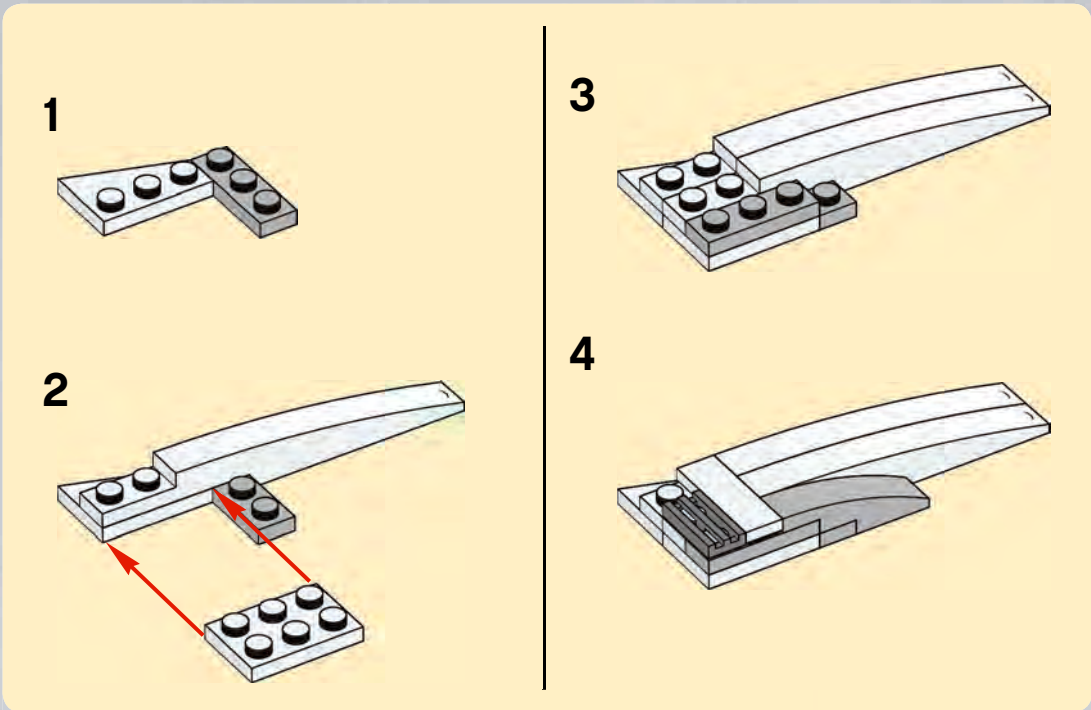

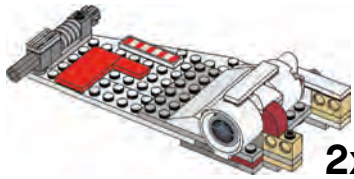
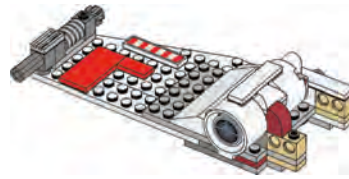
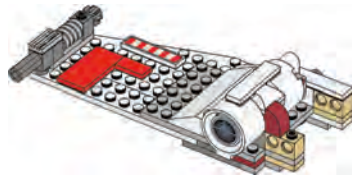

2x

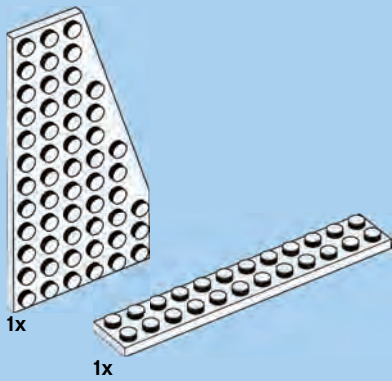

1x

1x

1

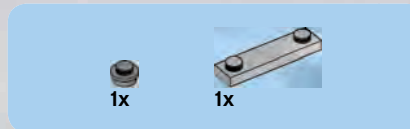
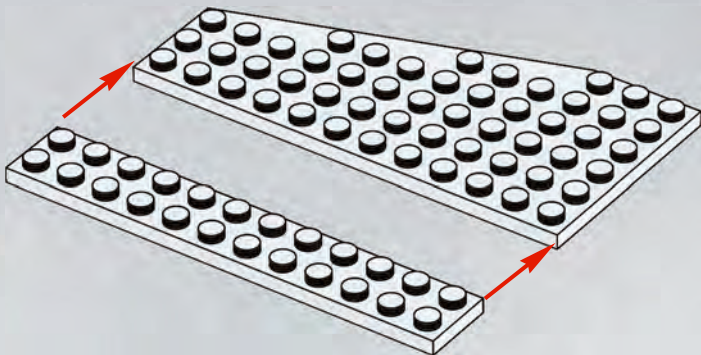

1x

1x

2

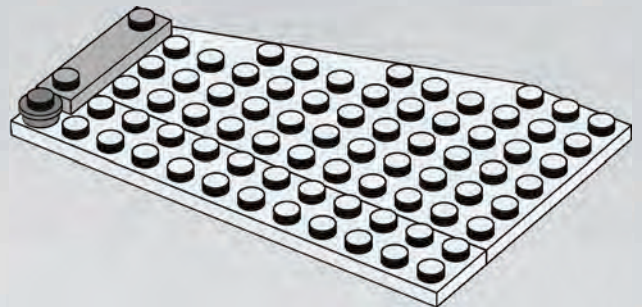





3

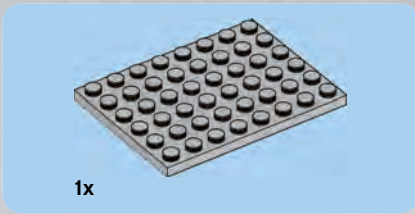
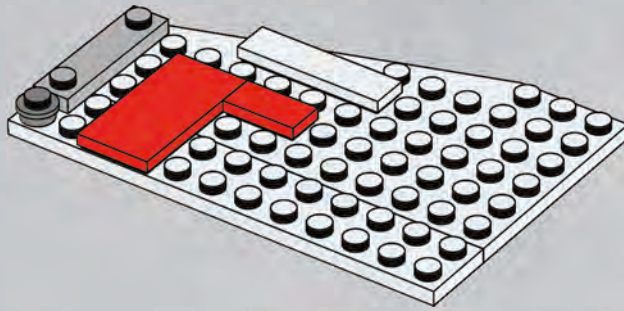

4

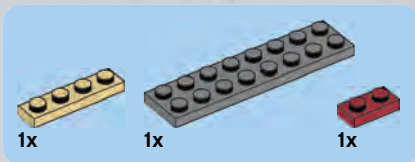
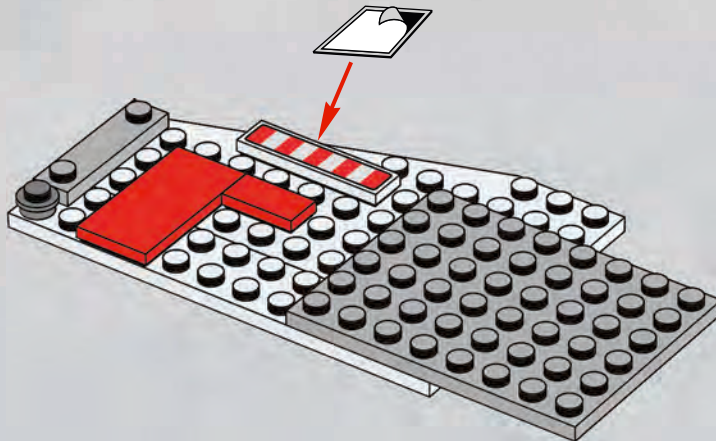

5

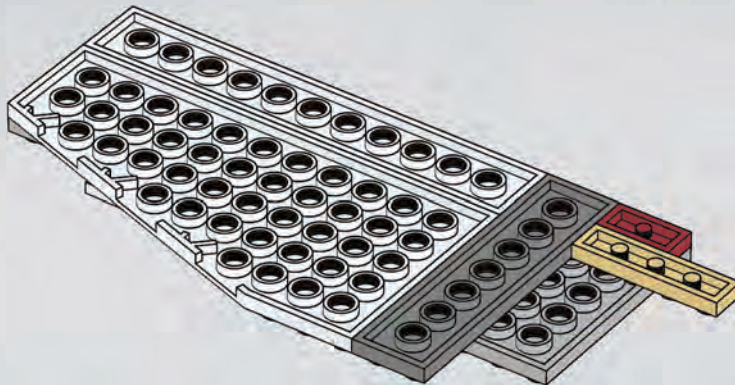

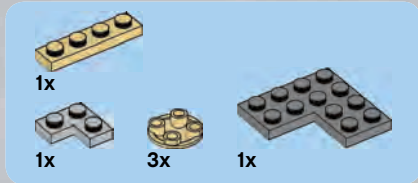

6

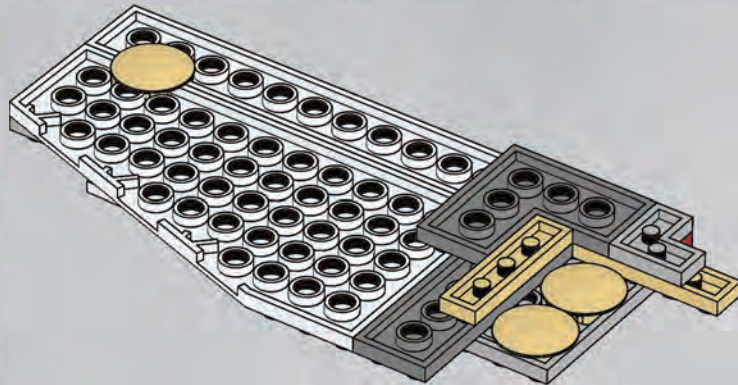

7

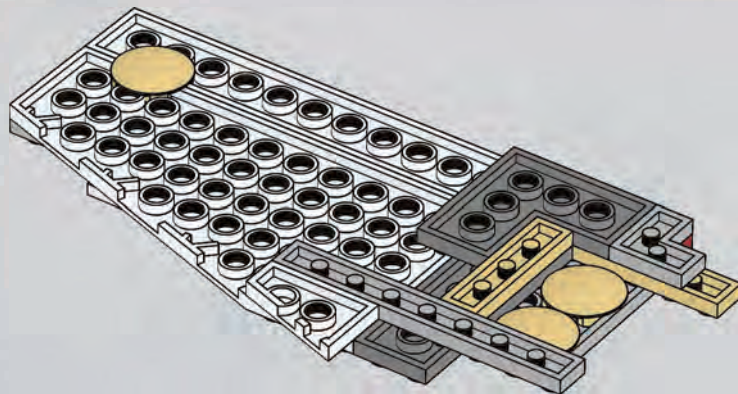

8

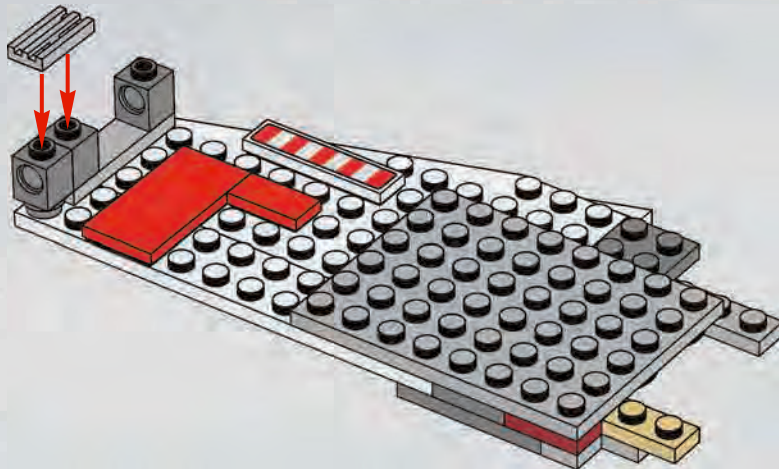



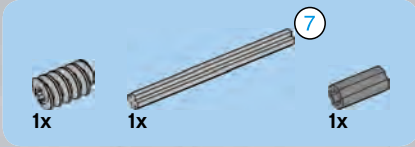

9

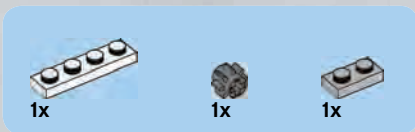
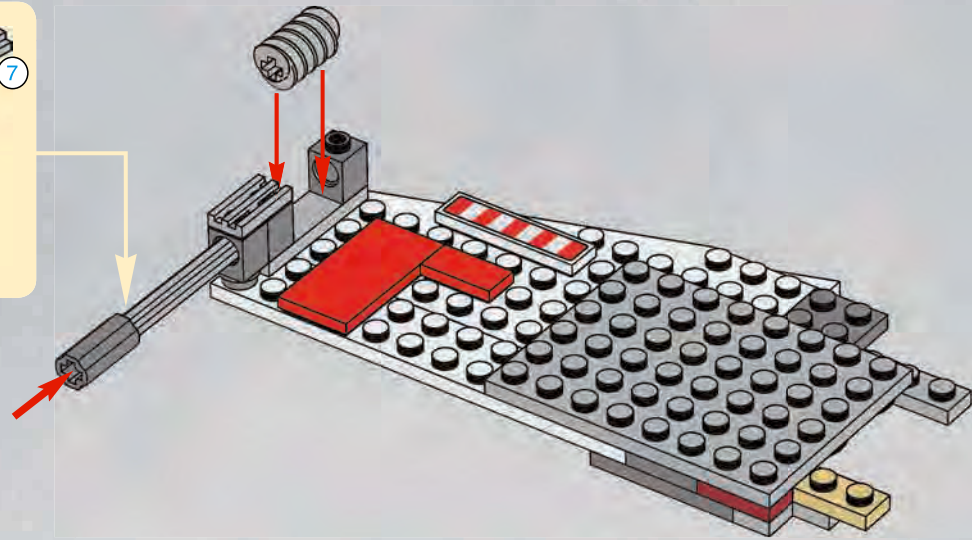
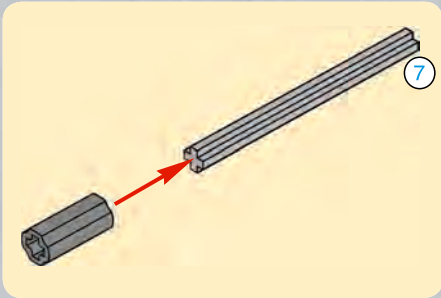

10

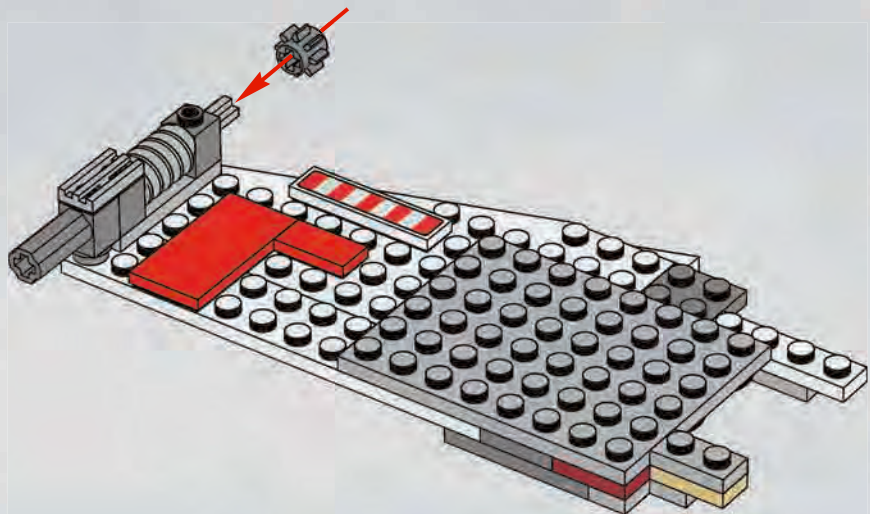

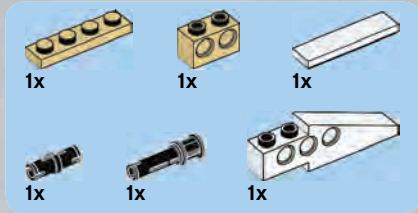

# 11

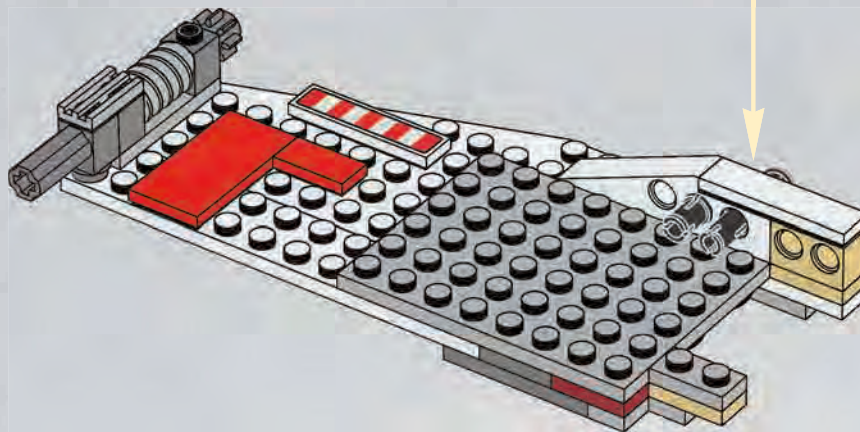
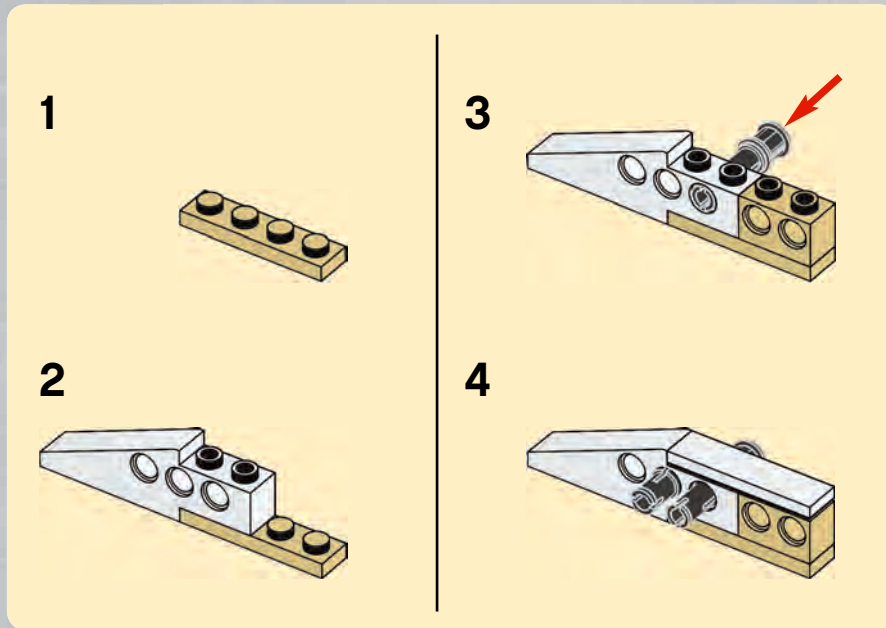





12

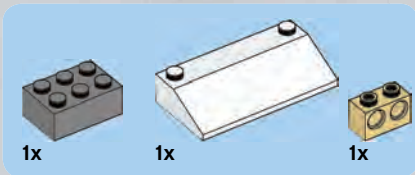
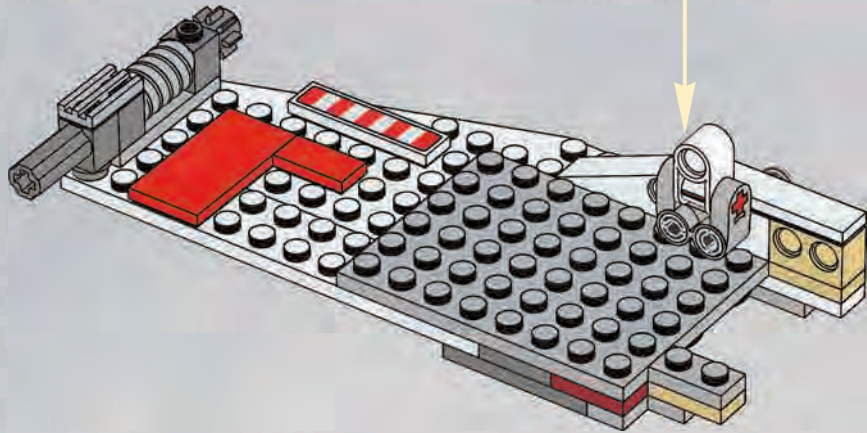
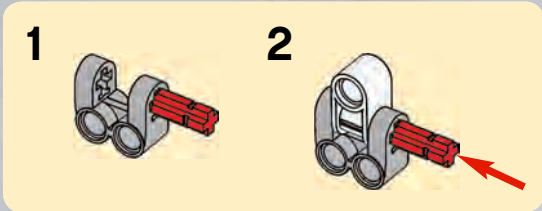

13

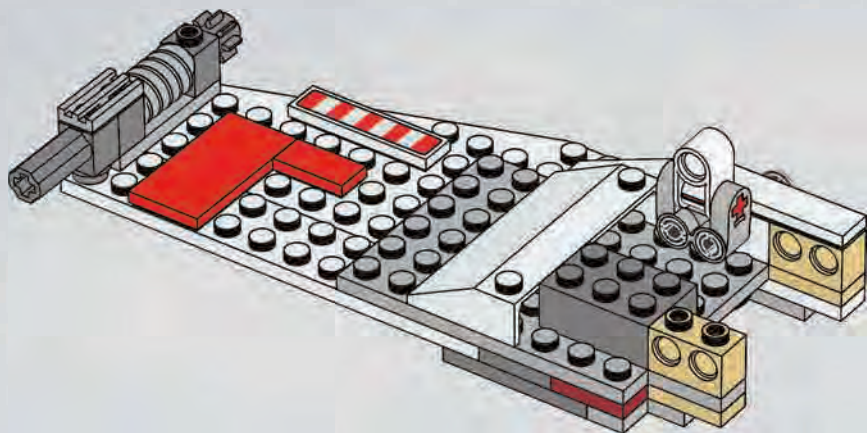

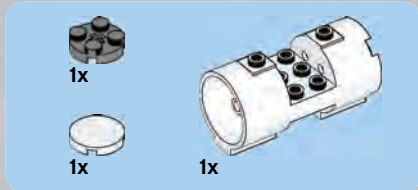

# 14

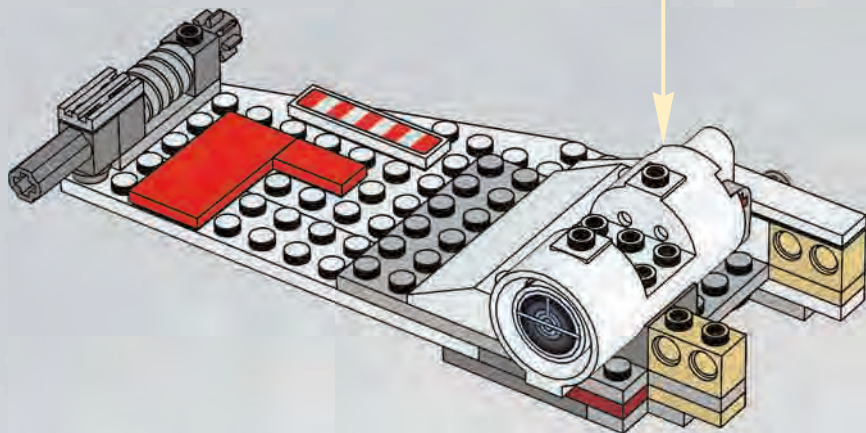
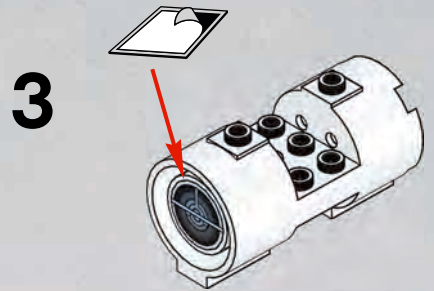
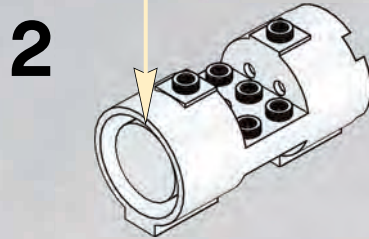
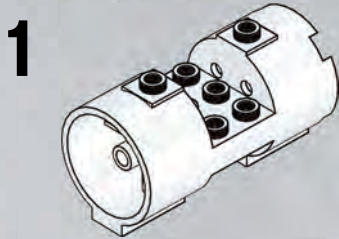





1x



1x



1x

# 15

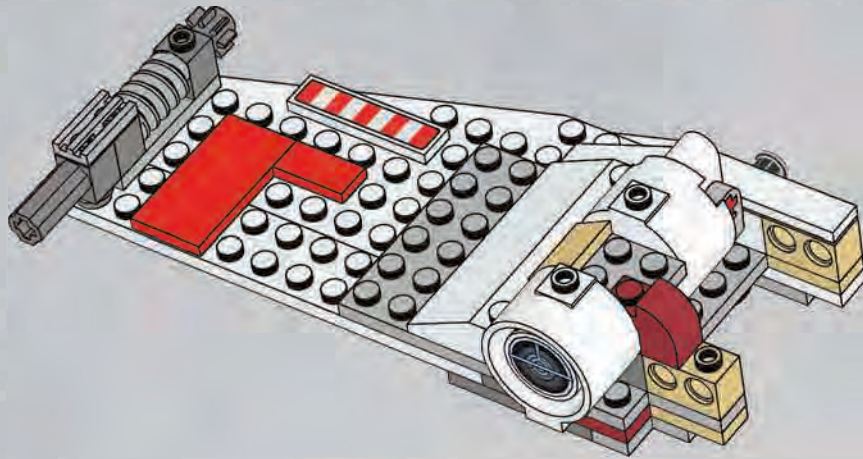

1x

# 16

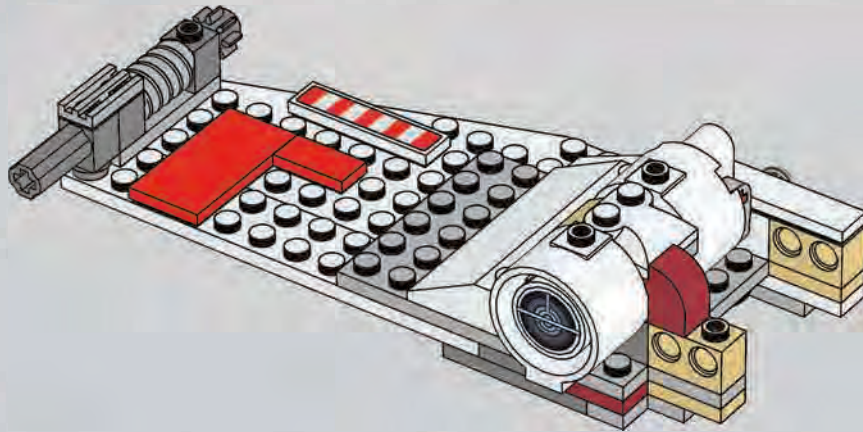

1x

# 17

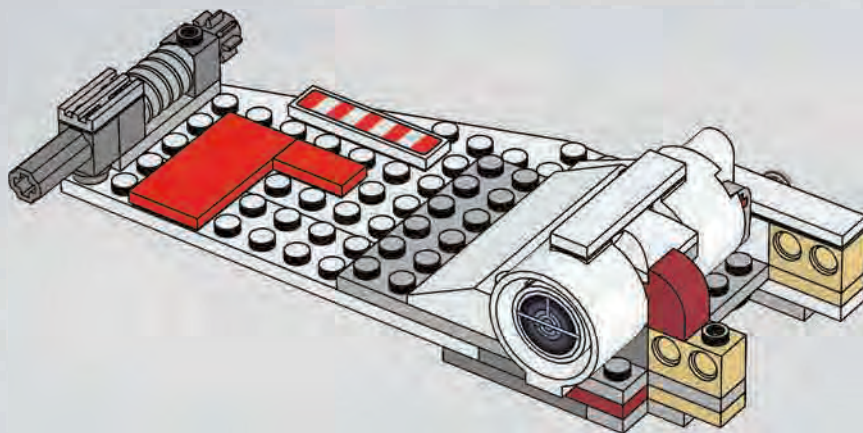

# 2x

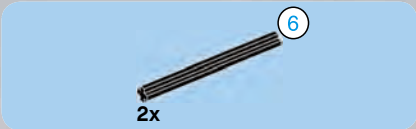

18

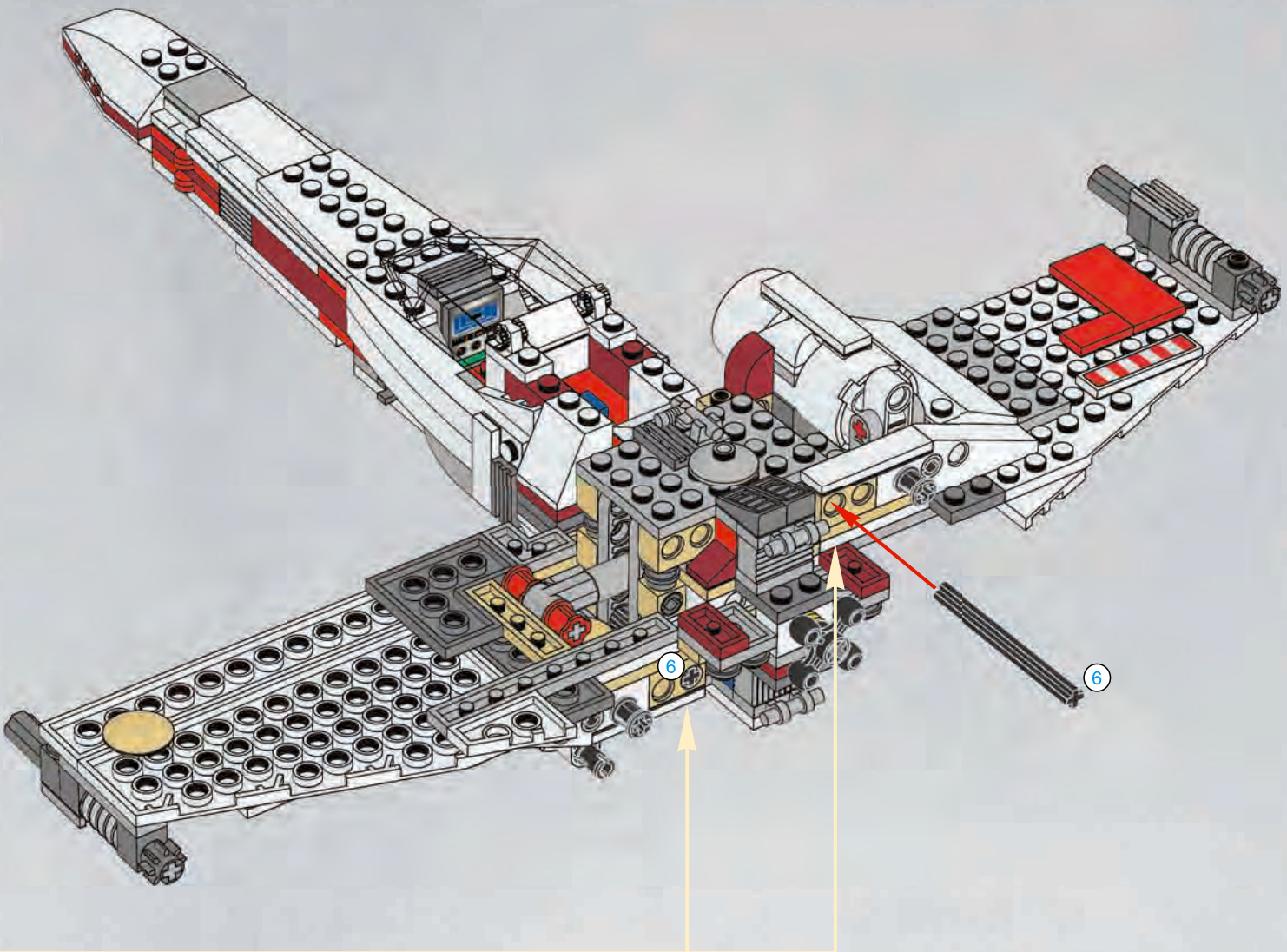





4

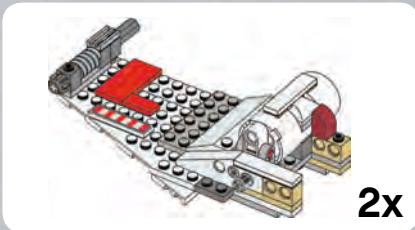
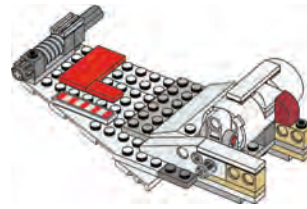
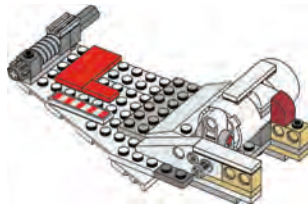

2x

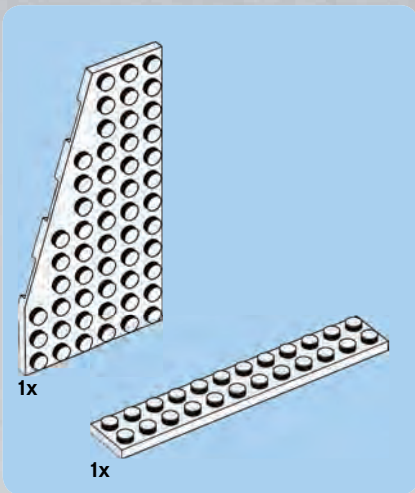

1x

1x

1

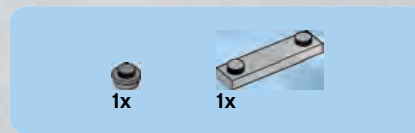
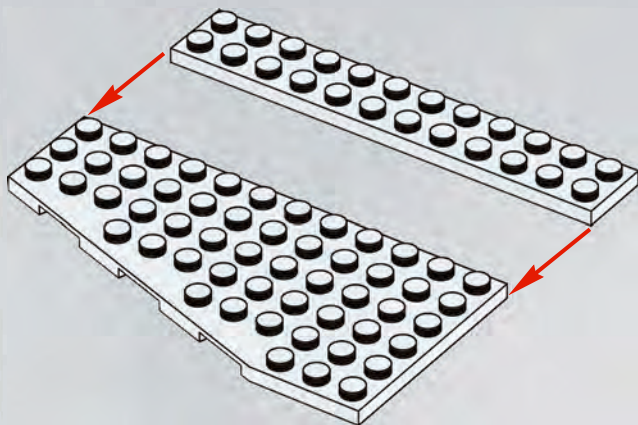

1x

1x

2

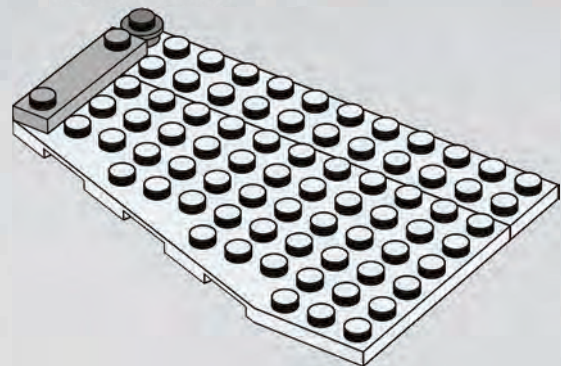

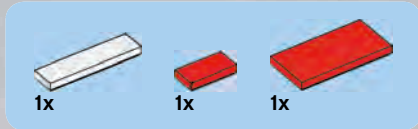

3

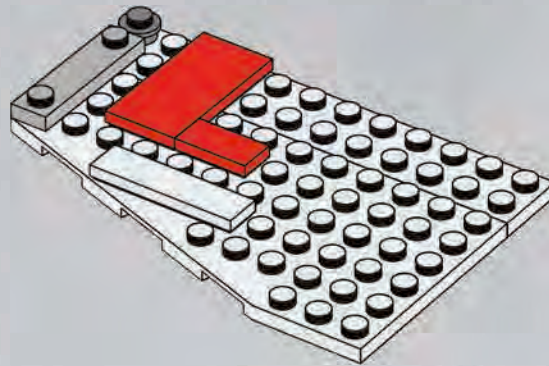

4

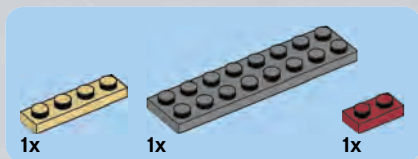
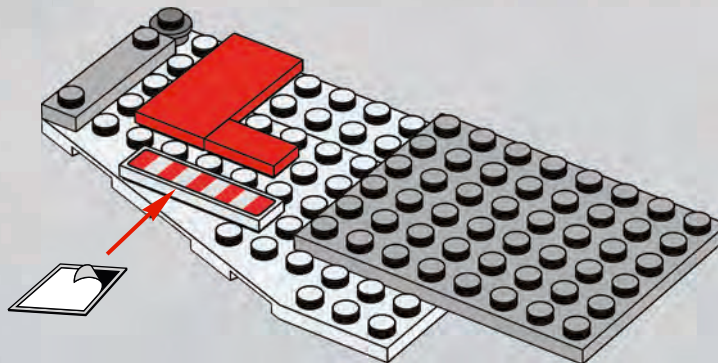

5

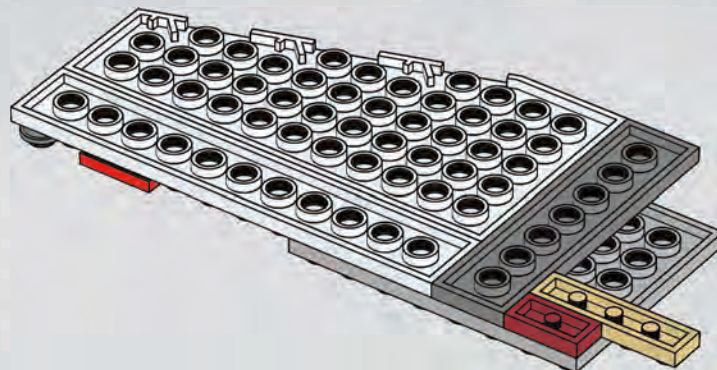



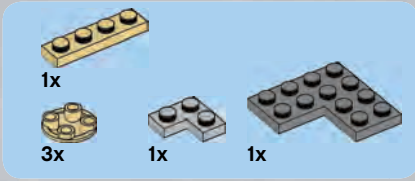

6

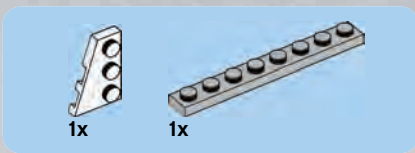
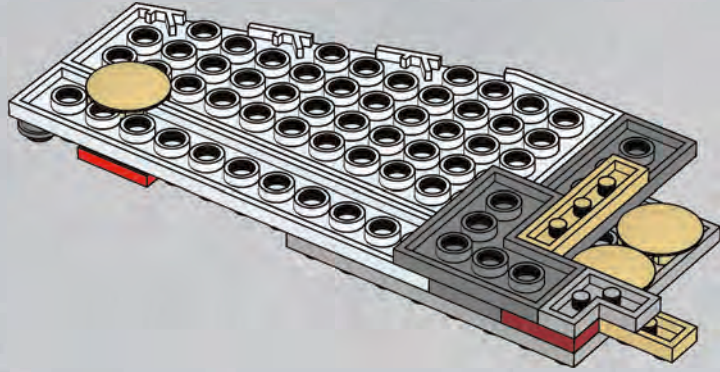

7

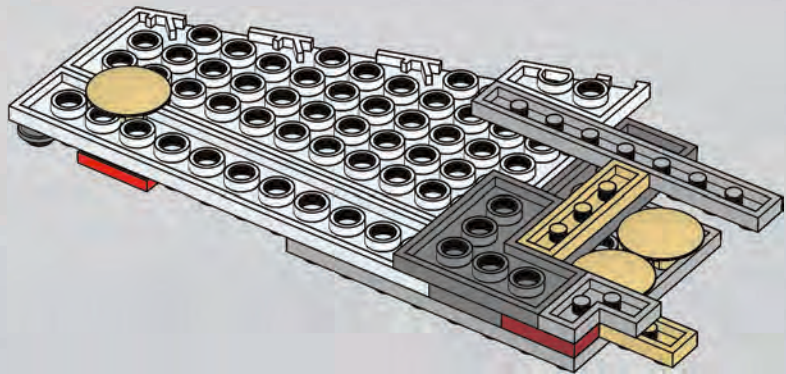

8

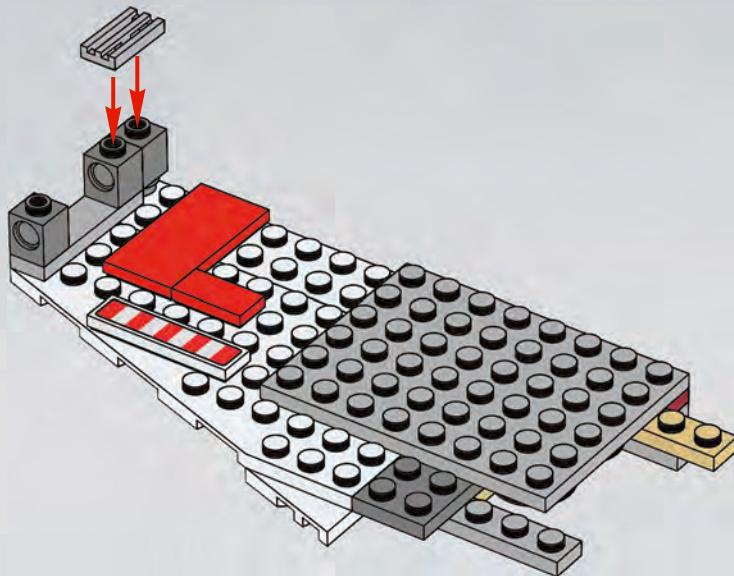

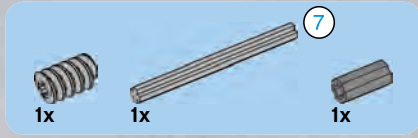

9

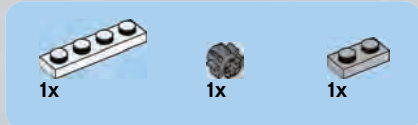
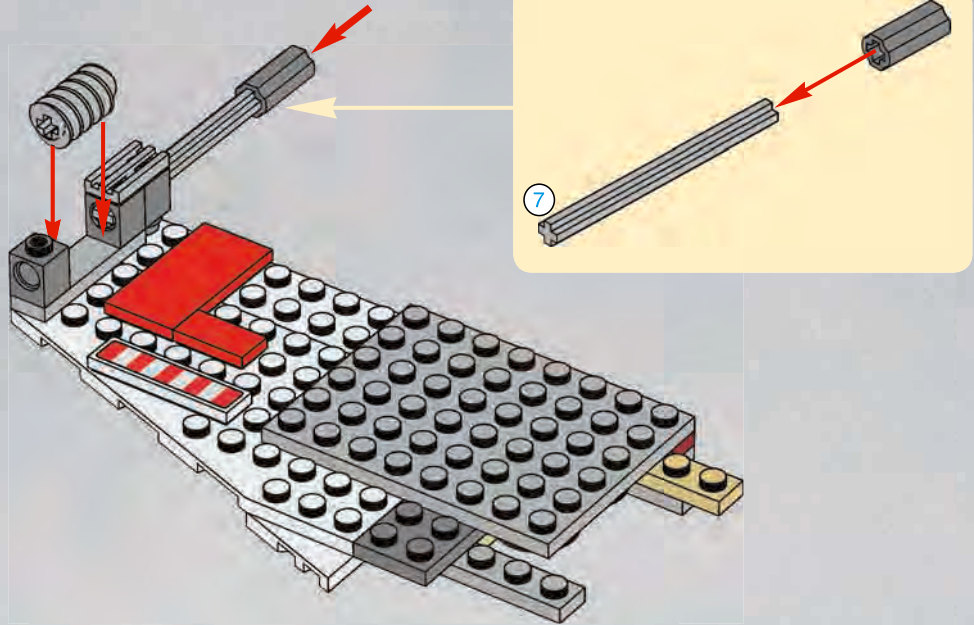

10

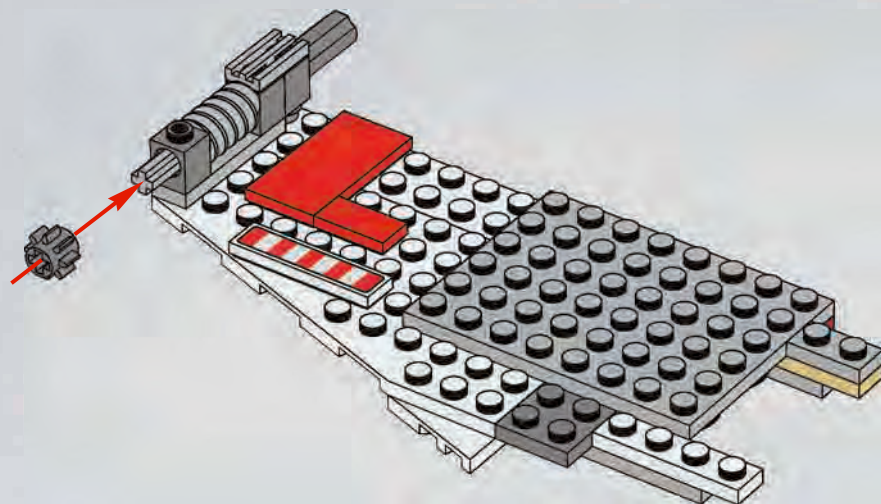



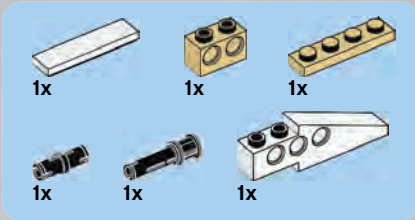

# 11

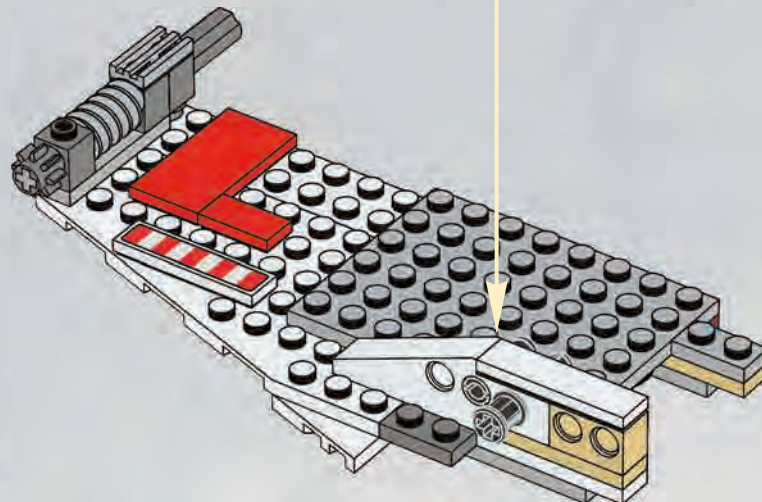
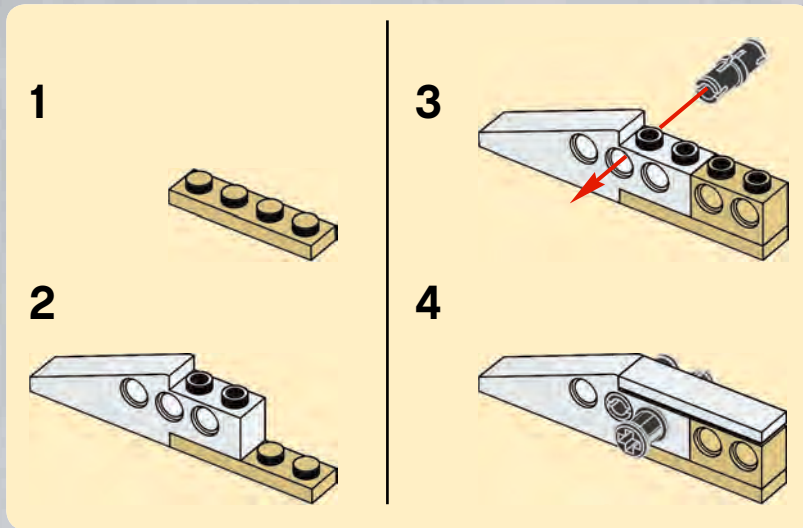



# 12

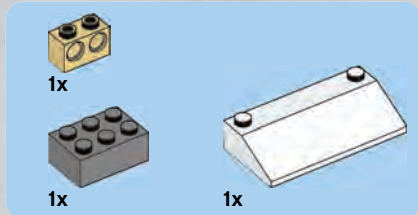
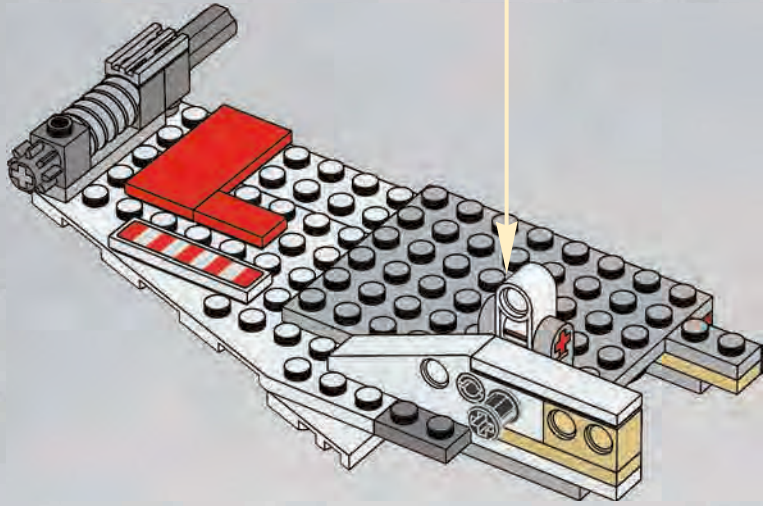
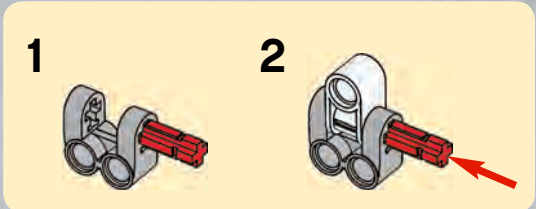

# 13

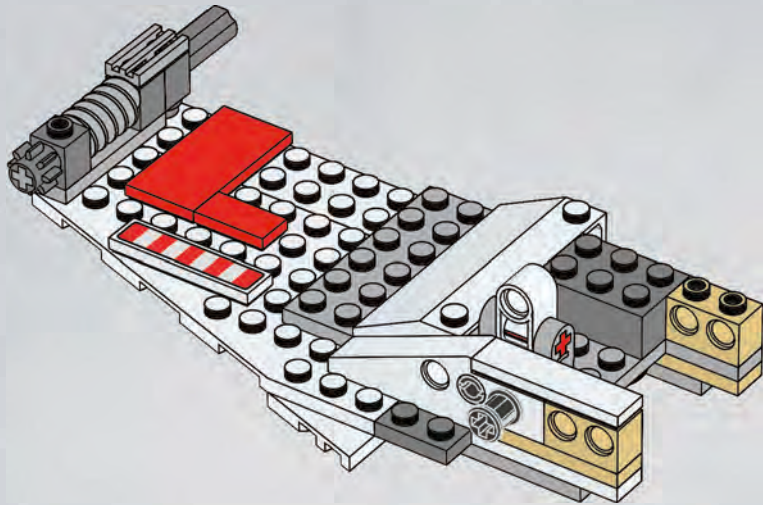



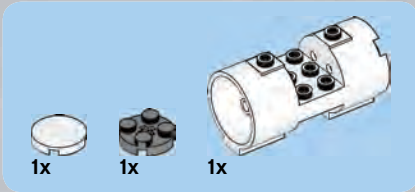

# 14

1

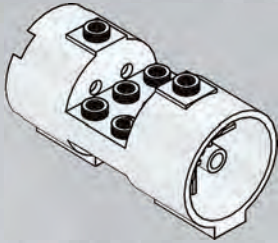

2

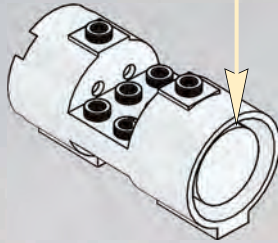

3

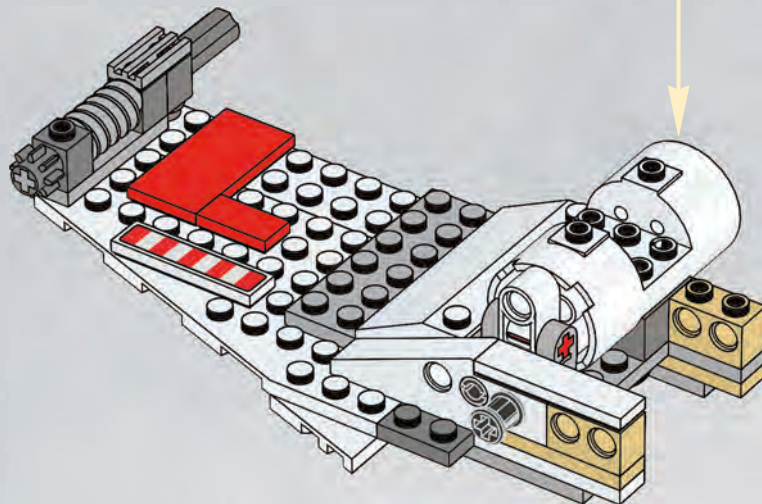
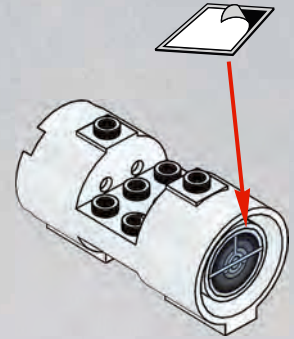



1x



1x



1x

# 15

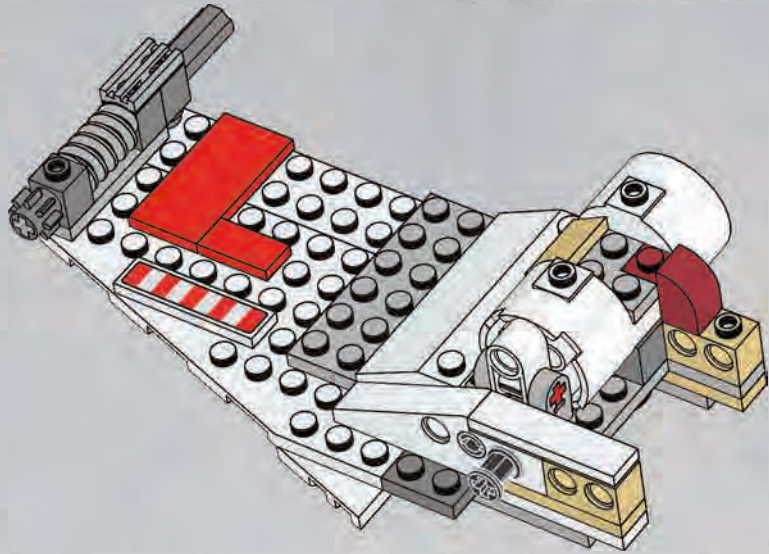

1x

# 16

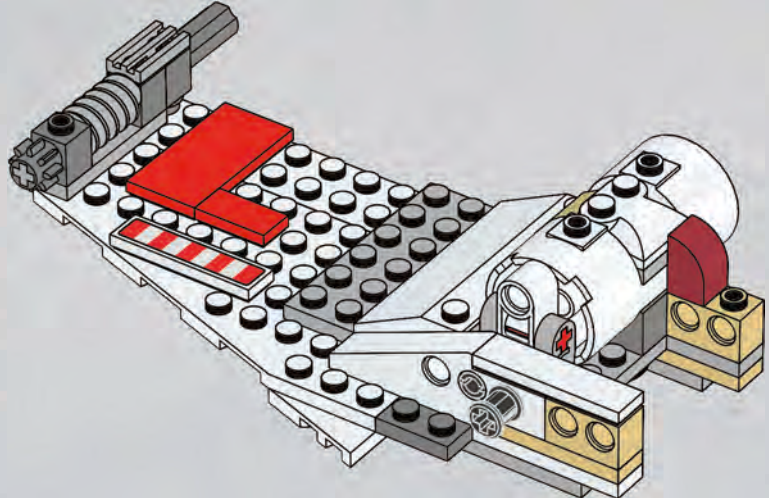

1x

# 17

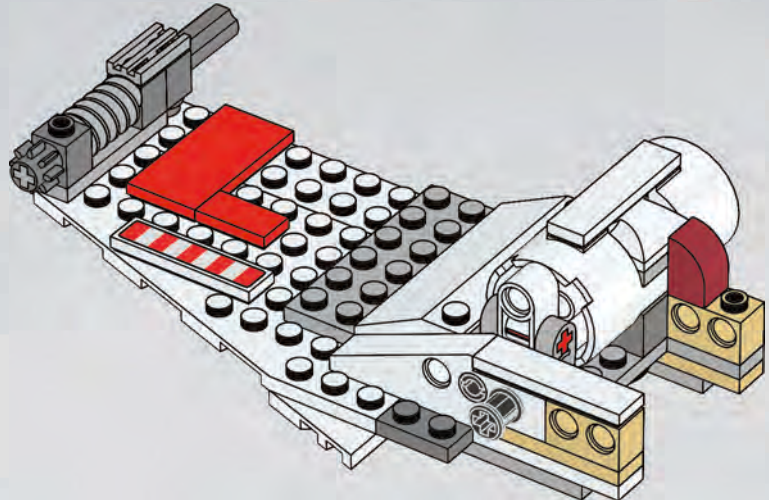

# 2x

53





18

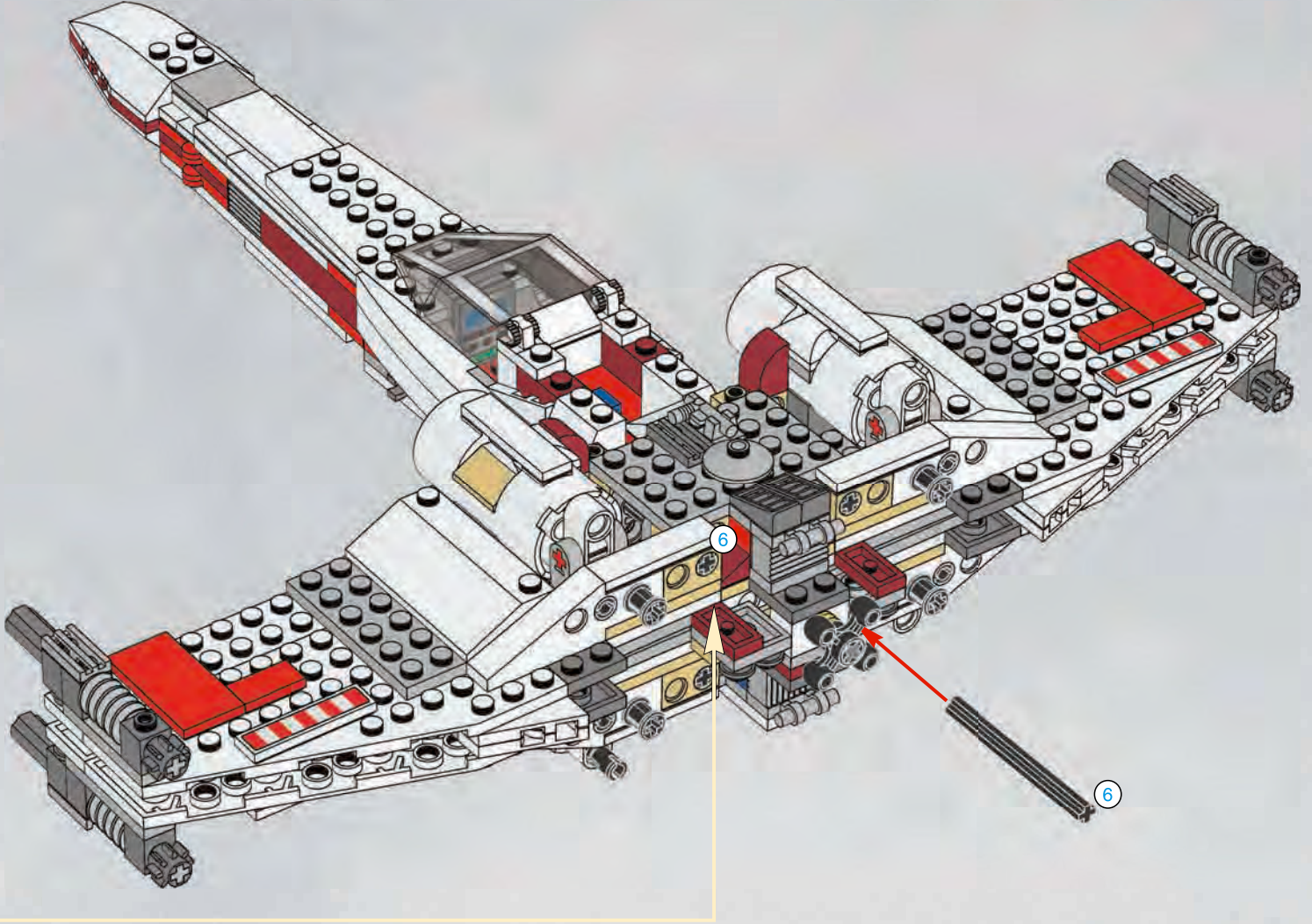





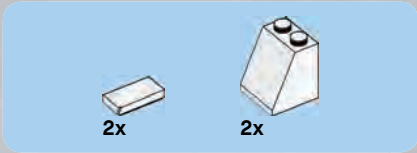

# 20

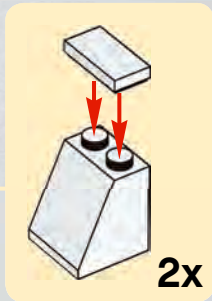
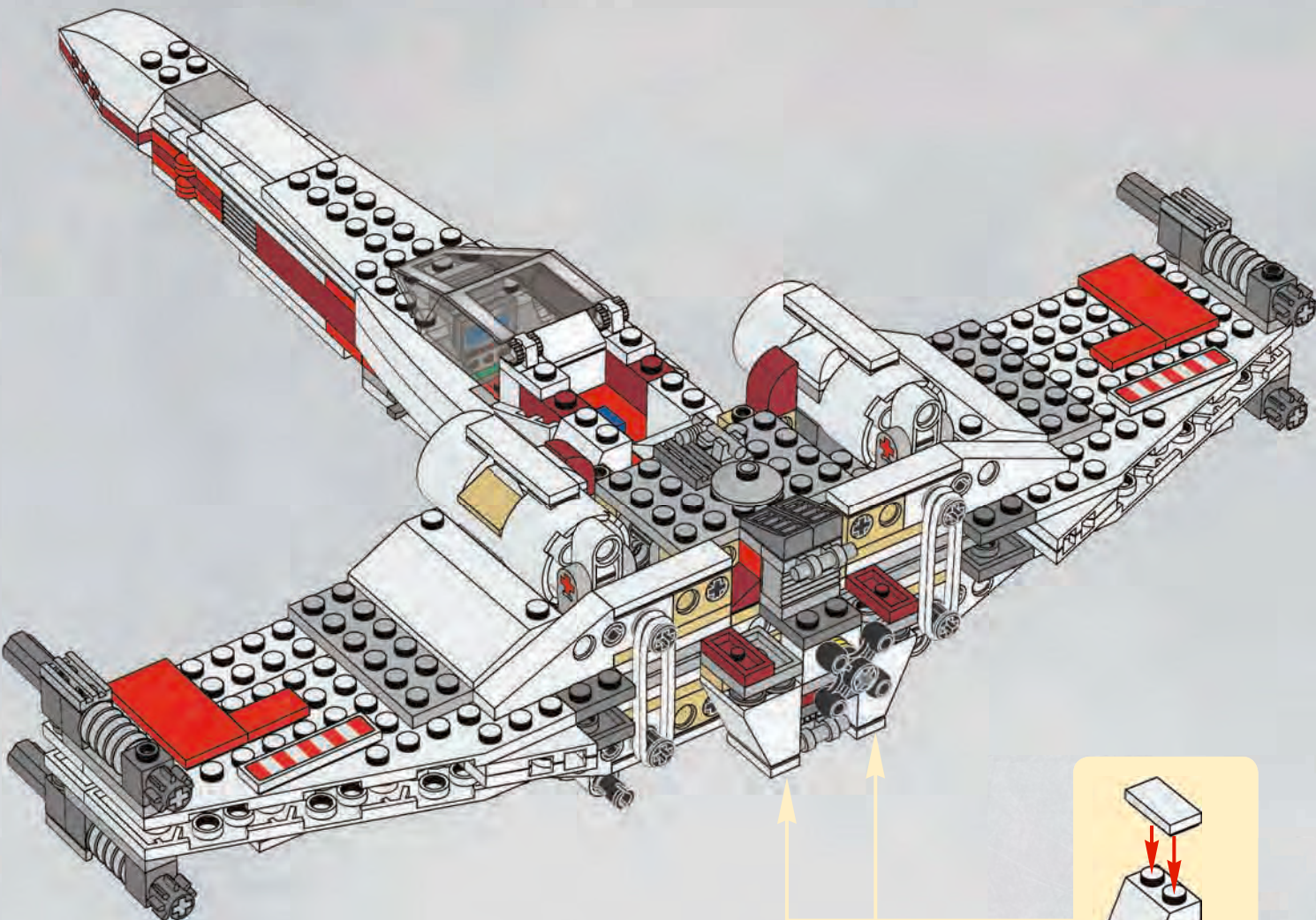

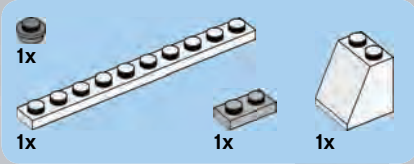

# 21

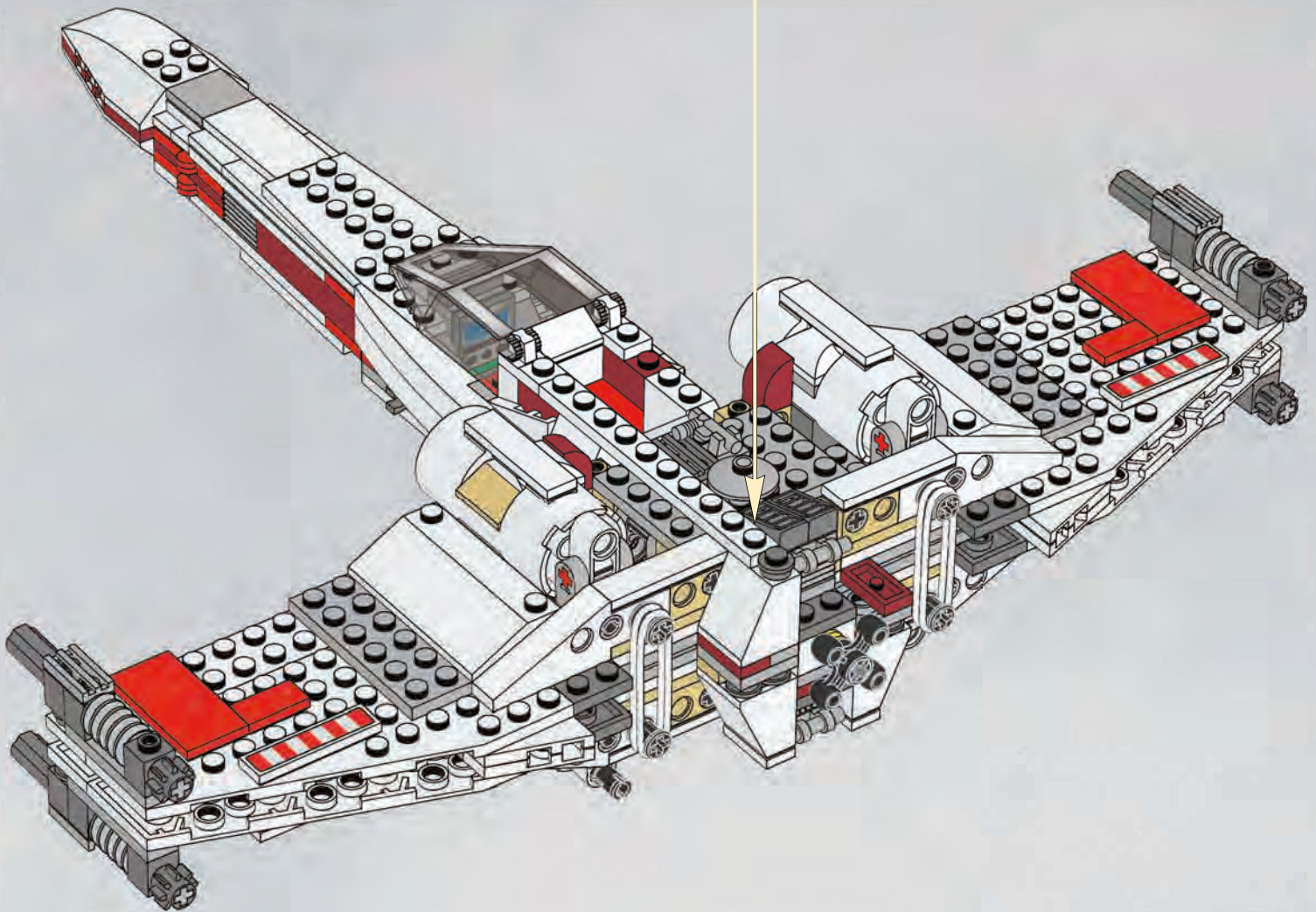
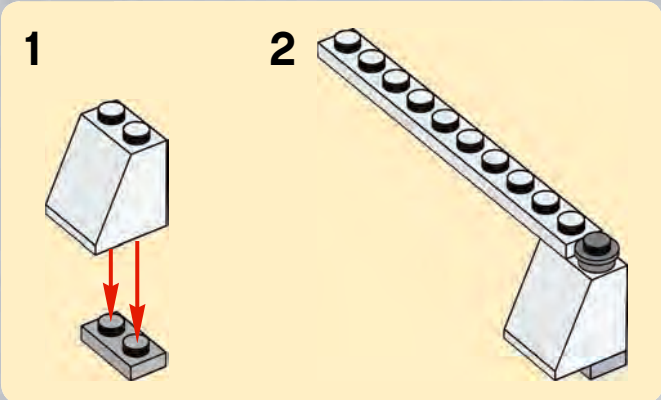



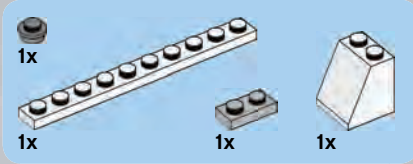

# 22

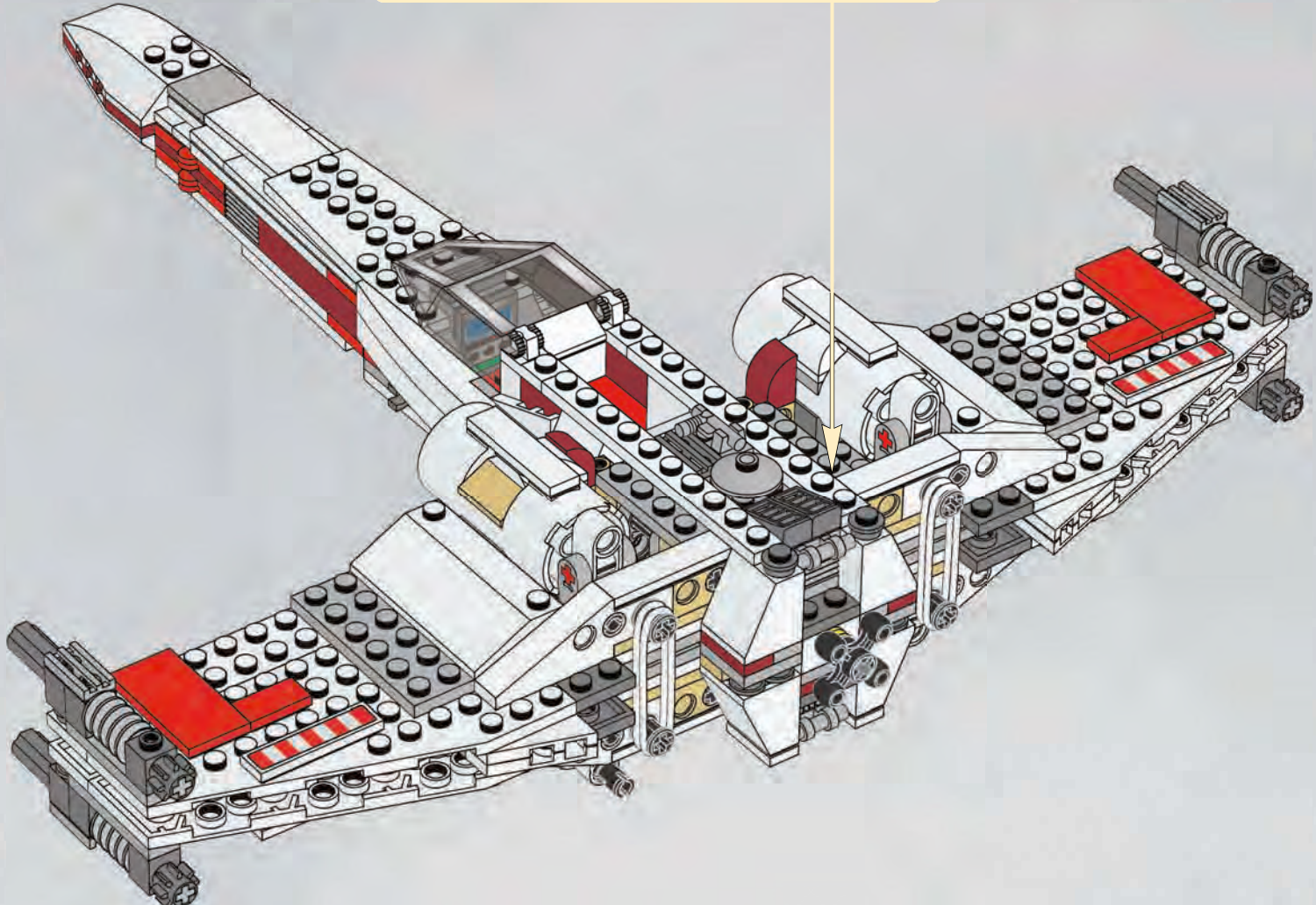
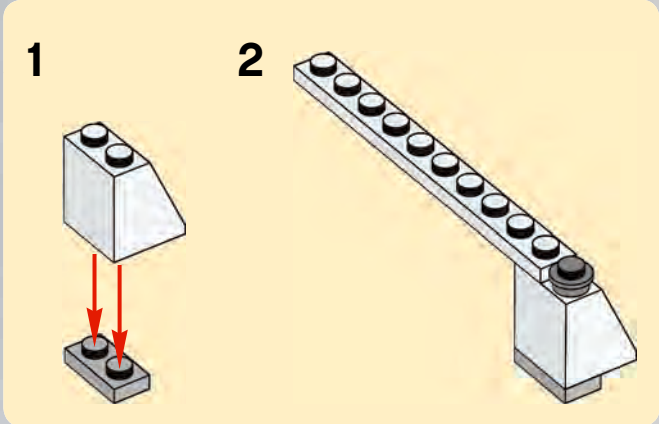



23

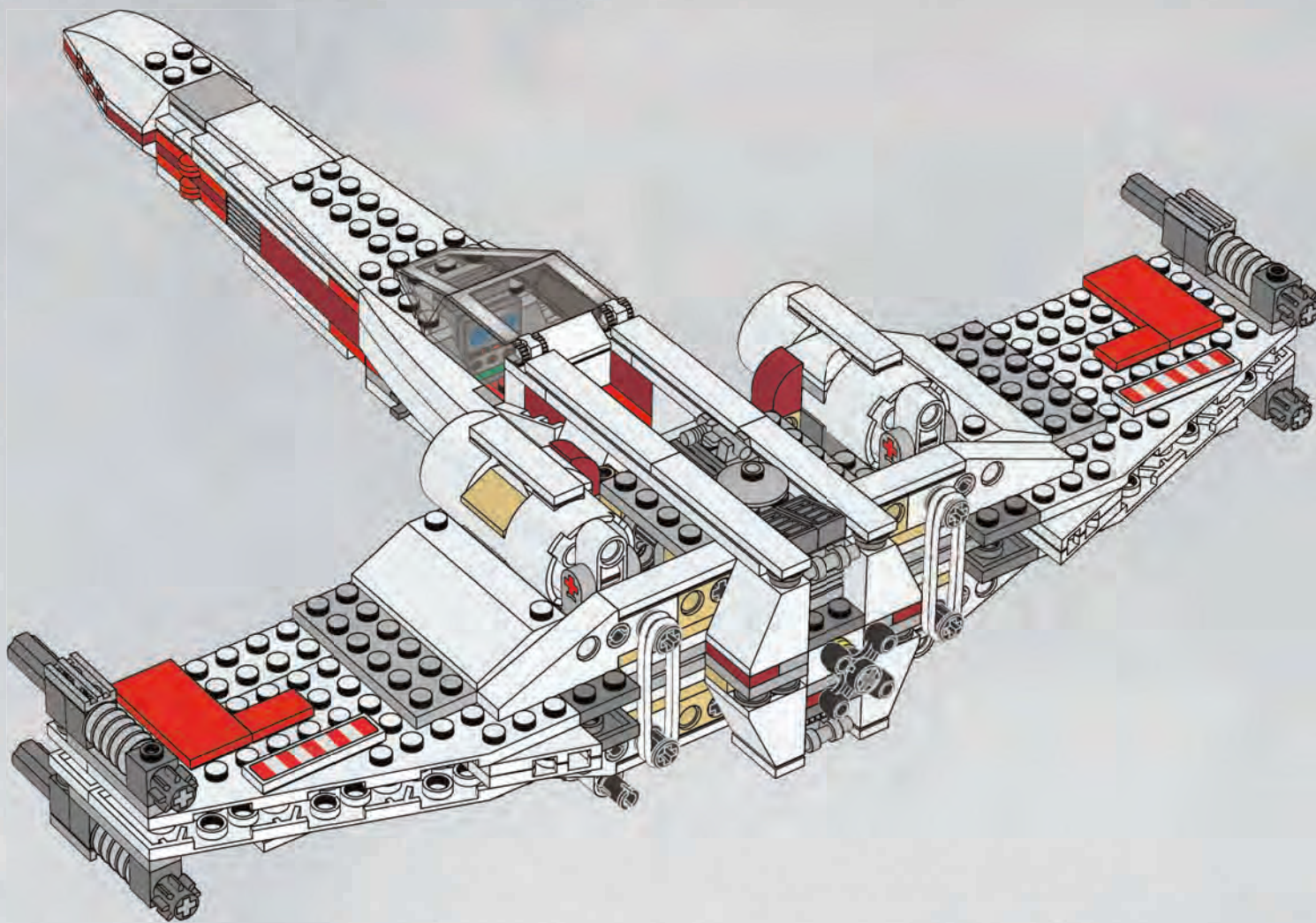





24

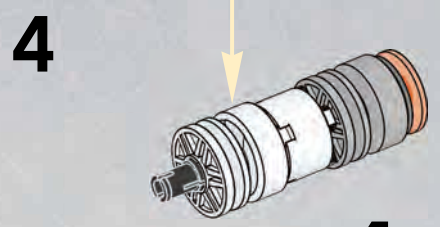
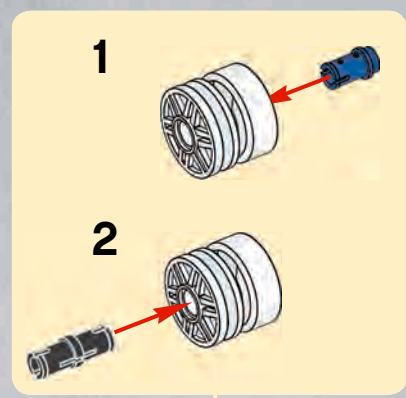
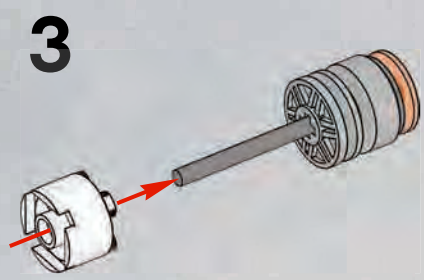
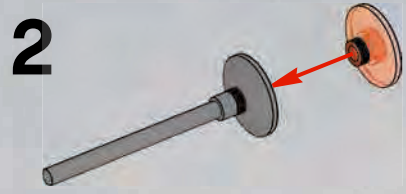

4x

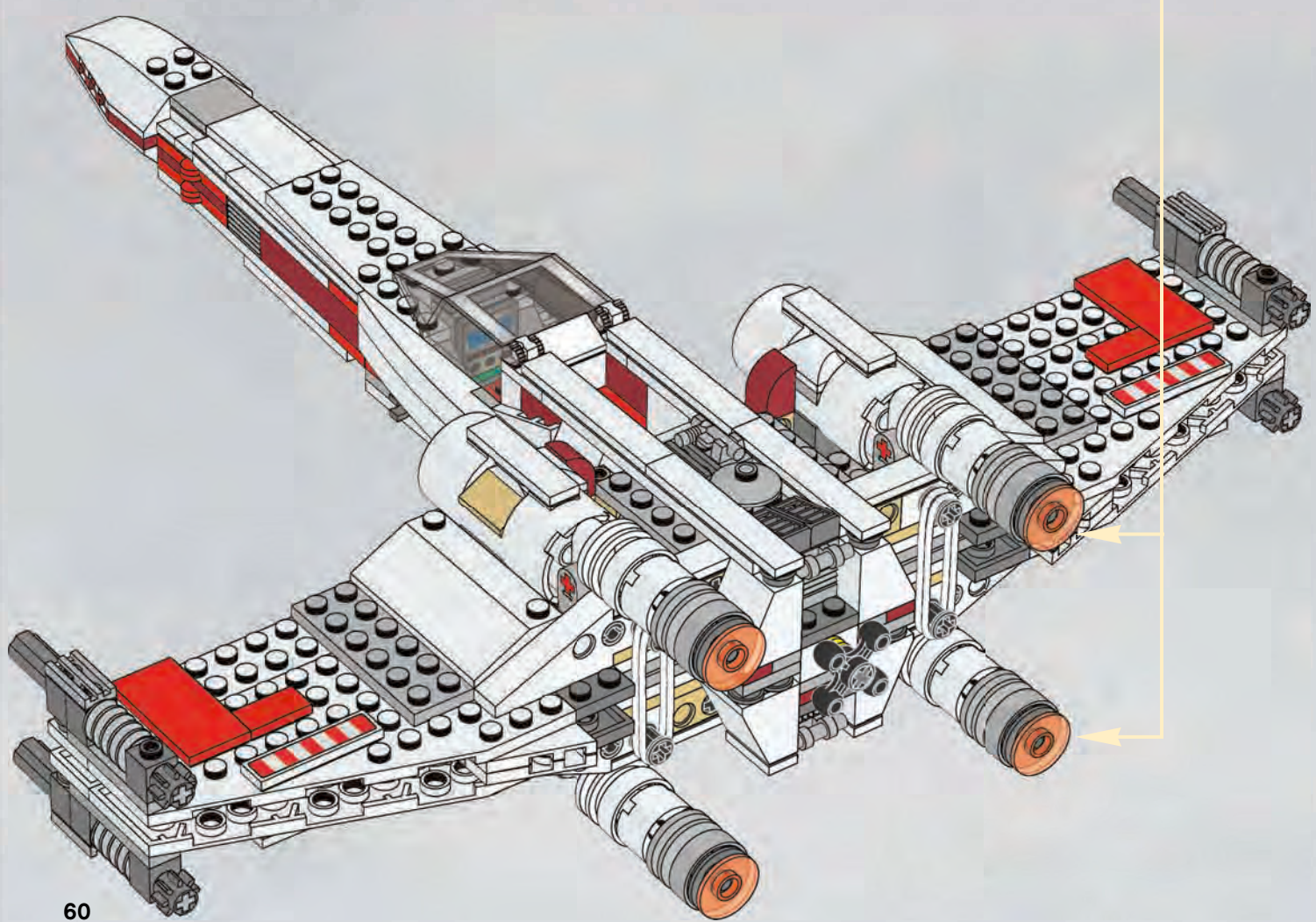

60

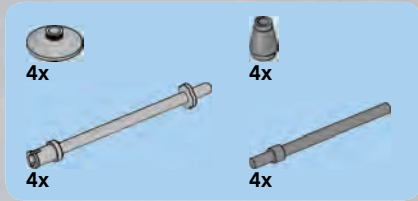

**25**

**1**



**2**

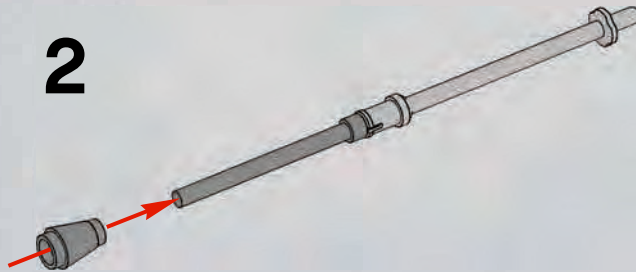

**3**

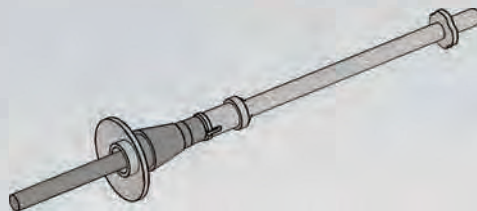

**4x**



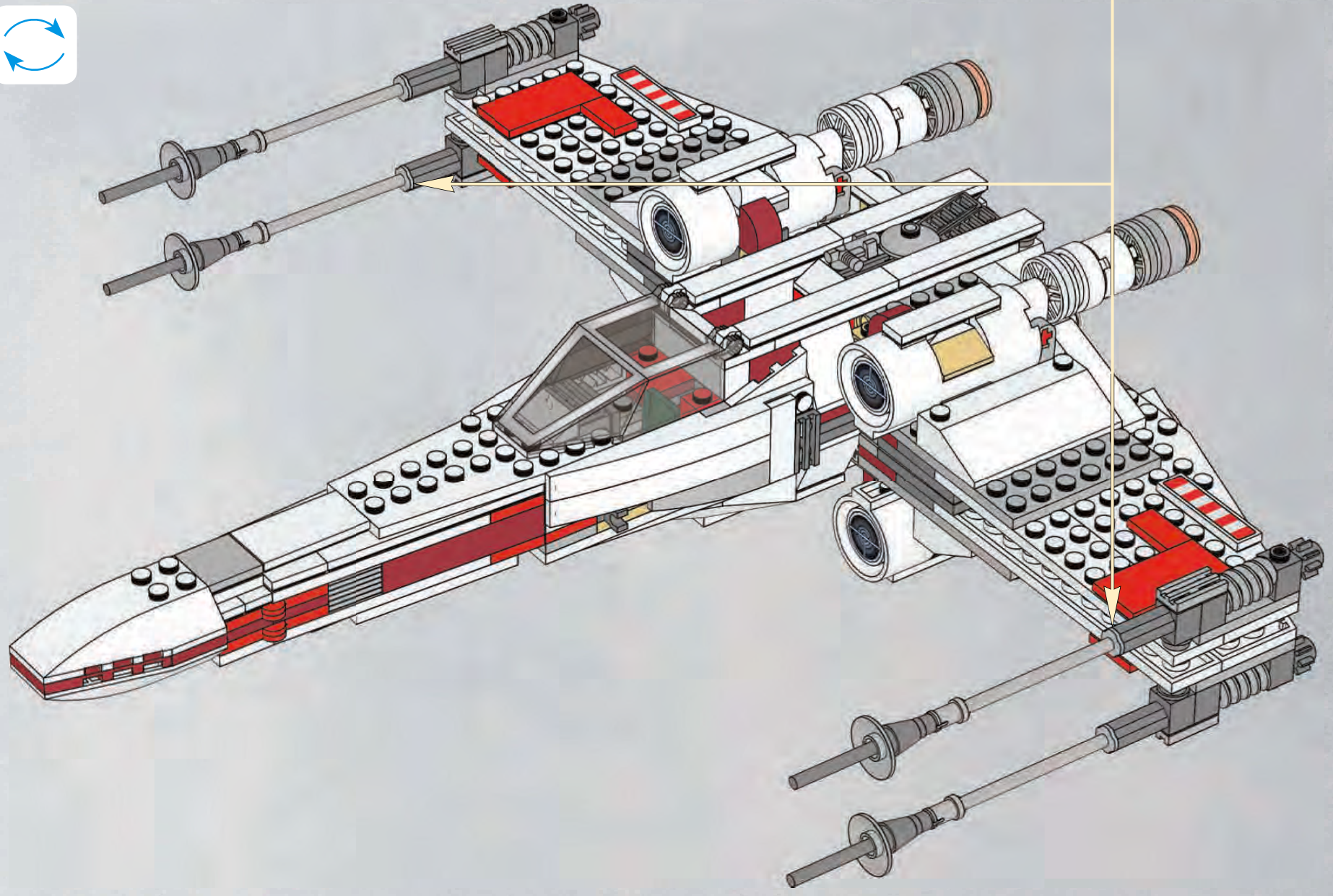





# 26

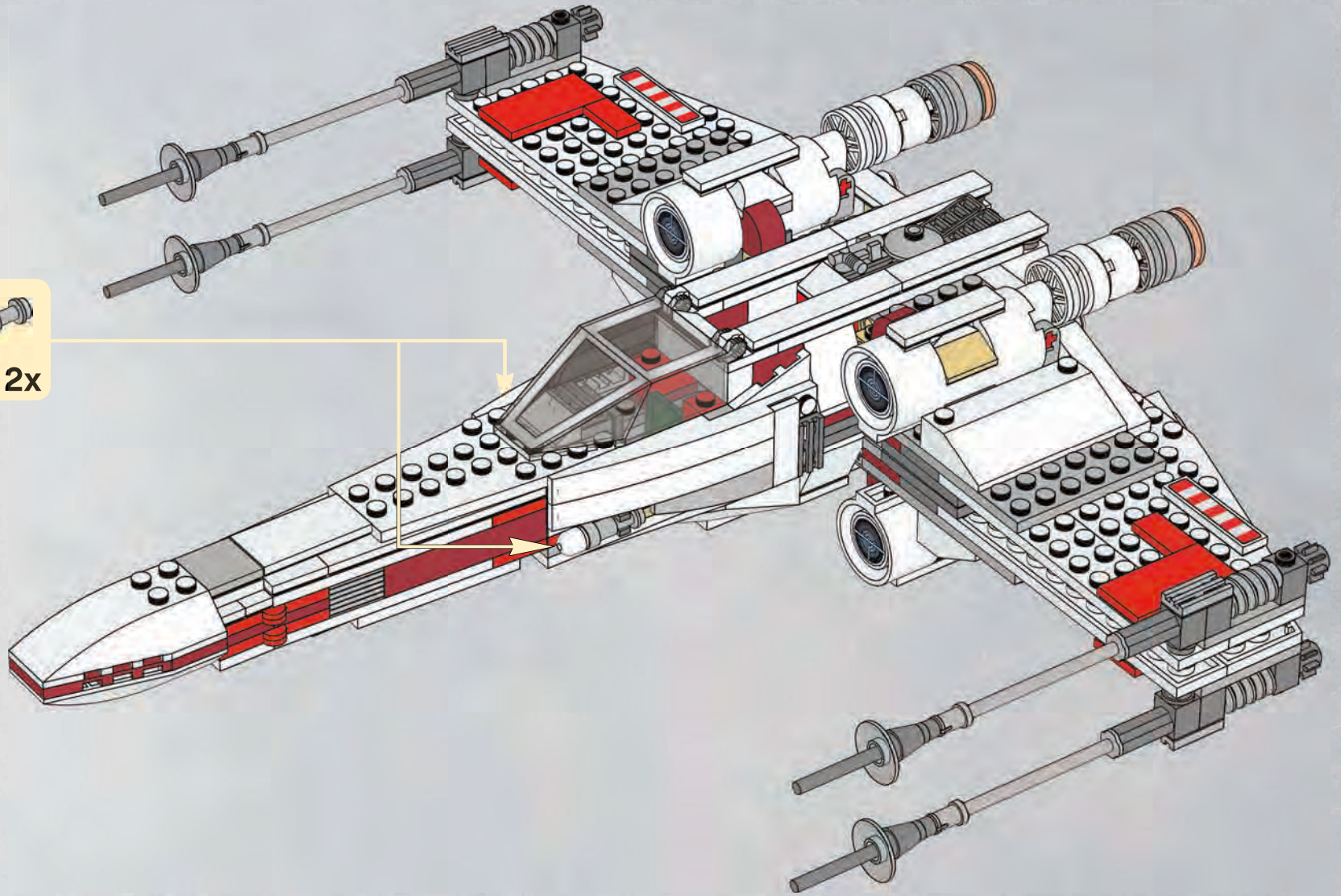
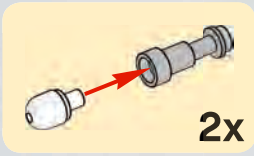



# 27

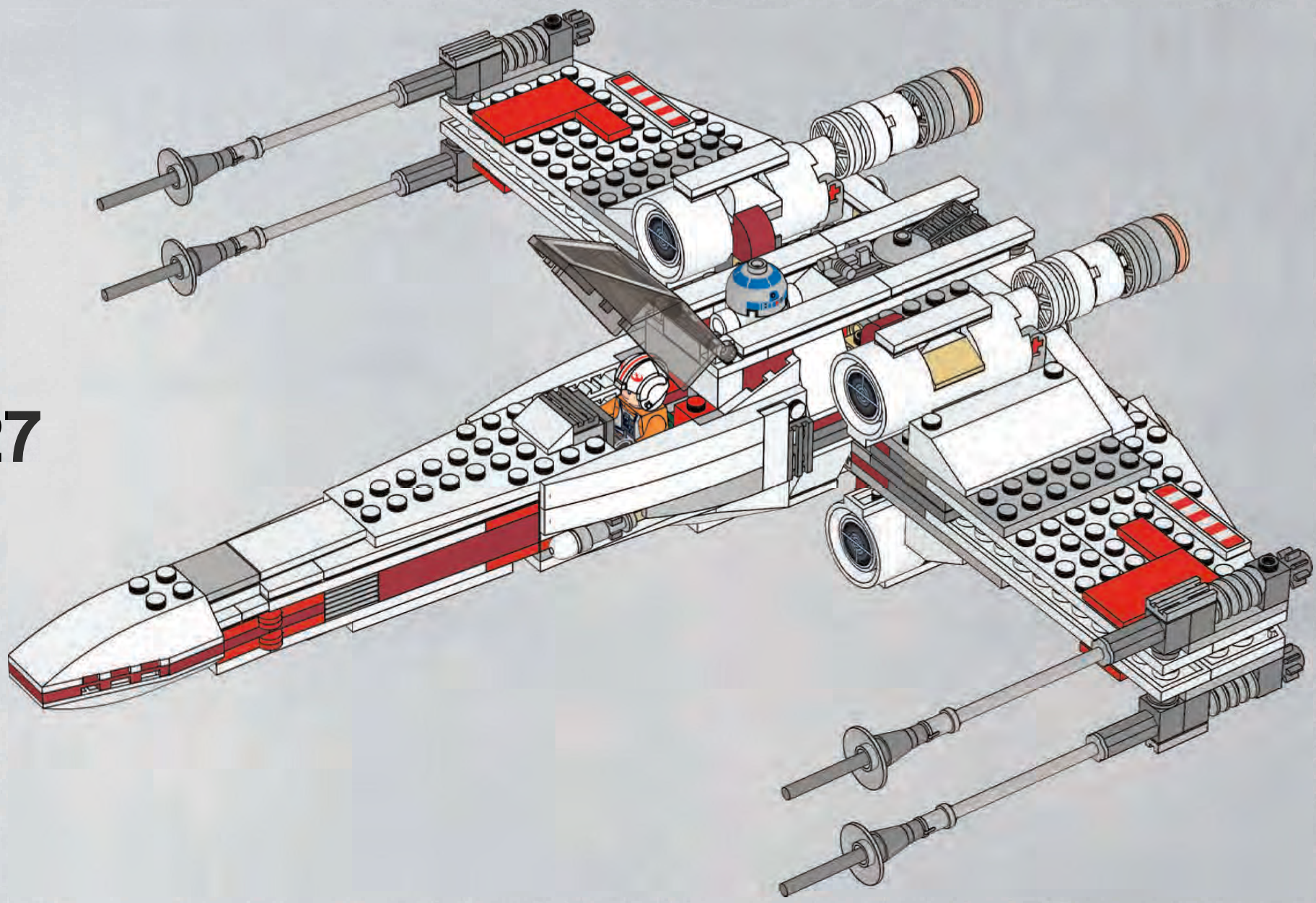





# 28



4x

1 

2  

4x

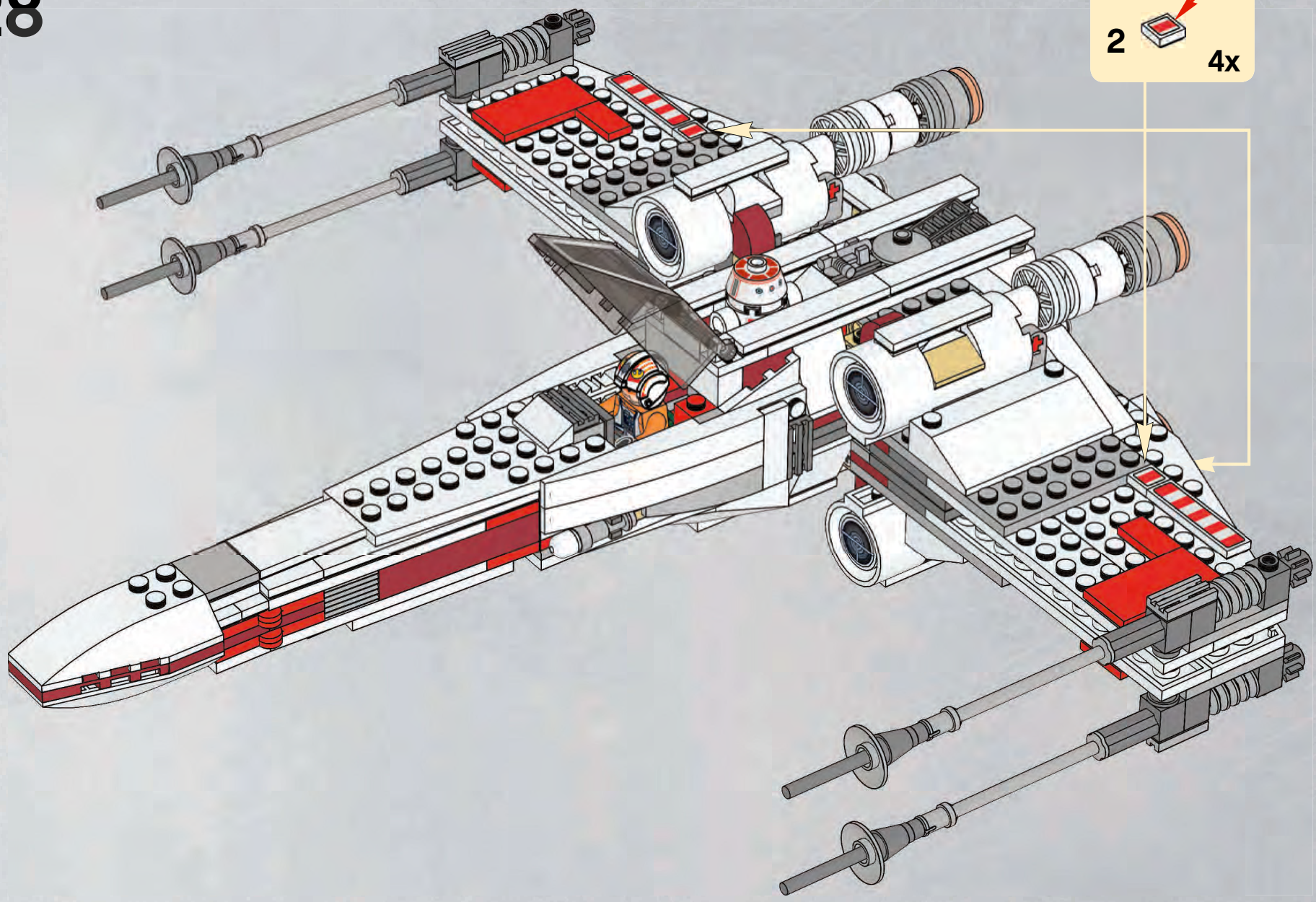



1x 301001  
 4x 614301  
 1x 4194011  
 1x 4655753  
 1x 4587276  
 4x 4629915  
 3x 370001  
 2x 370101  
 4x 4528417  
 3x 4547489  
 8x 4234525  
 1x 4567894  
 4x 4547368  
 1x 4261693  
 1x 4179869  
 4x 307001

2x 4623199  
 4x 302101  
 2x 302001  
 4x 366601  
 4x 346001  
 5x 447701  
 5x 244501  
 4x 415001  
 2x 4262011  
 6x 306901  
 4x 4558168  
 12x 243101  
 1x 4560178  
 4x 663601  
 2x 416201  
 3x 4179874  
 3x 4179875

2x 4141475  
 2x 4141476  
 2x 241301  
 1x 4653823  
 4x 371001  
 4x 4490141  
 4x 4124113  
 4x 4569841  
 4x 4494474  
 4x 4544140  
 4x 4173670  
 20x 4523145  
 4x 4624086  
 14x 4113233  
 5x 4124067  
 12x 4278422  
 1x 4514557

2x 300321  
 4x 4157223  
 1x 4207715  
 4x 306921  
 4x 4560179  
 8x 74230  
 5x 4227155  
 6x 4142865  
 1x 300123  
 1x 300723  
 2x 4119014  
 5x 379423  
 2x 4186834  
 7x 4143005  
 1x 4188313  
 2x 4239601  
 1x 329826  
 1x 4498713  
 1x 4158848  
 3x 4107783  
 8x 4121715

4x 4140801  
 4x 370626  
 1x 373726  
 1x 4177431  
 1x 4248204  
 3x 4233489  
 1x 4548731  
 1x 4124073  
 4x 3006347  
 2x 4214921  
 2x 4570764  
 1x 4499899  
 1x 4538760  
 4x 4539102  
 2x 4541528  
 4x 4539082  
 23x 4539097  
 1x 4561032  
 2x 4531415

1x 4533122  
 2x 4211614  
 2x 4532593  
 13x 4211398  
 10x 4211353  
 5x 4211397  
 6x 4211429  
 8x 4599498  
 3x 4612621  
 1x 4243797  
 4x 4211425  
 1x 4211404  
 2x 4251149  
 4x 4211408  
 1x 4211369  
 4x 4211383  
 4x 4211510  
 2x 4526985

2x 4211414  
 4x 4211350  
 1x 4277927  
 2x 4211632  
 2x 4211413  
 2x 4211804  
 1x 4211802  
 5x 4211512  
 2x 4657366  
 1x 4514195  
 4x 4490127  
 4x 4211859  
 4x 4503416  
 4x 4211889  
 2x 4211550  
 3x 4211815  
 1x 4211639  
 4x 4211805  
 1x 4655786  
 1x 4569715

**Customer Service**  
 Kundenservice  
 Service Consommateurs  
 Servicio Al Consumidor  
[www.lego.com/service](http://www.lego.com/service) or dial  
 00800 5346 5555 :         
 1-800-422-5346 :  

- 4x 4211105
- 4x 4529240
- 12x 4210639
- 2x 4621917
- 1x 421054
- 2x 4211043
- 4x 4539429
- 2x 4211002
- 6x 4210997
- 2x 45779354
- 4x 4210631
- 1x 4514441
- 27x 4210633
- 4x 4211042
- 4x 4211010
- 8x 4538721
- 2x 4540386
- 4x 4211050
- 4x 4516546
- 2x 4508553
- 4x 4514559

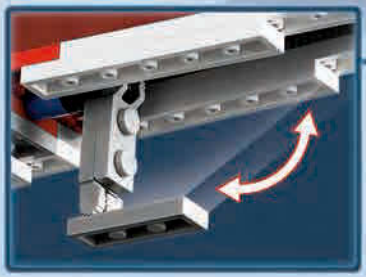
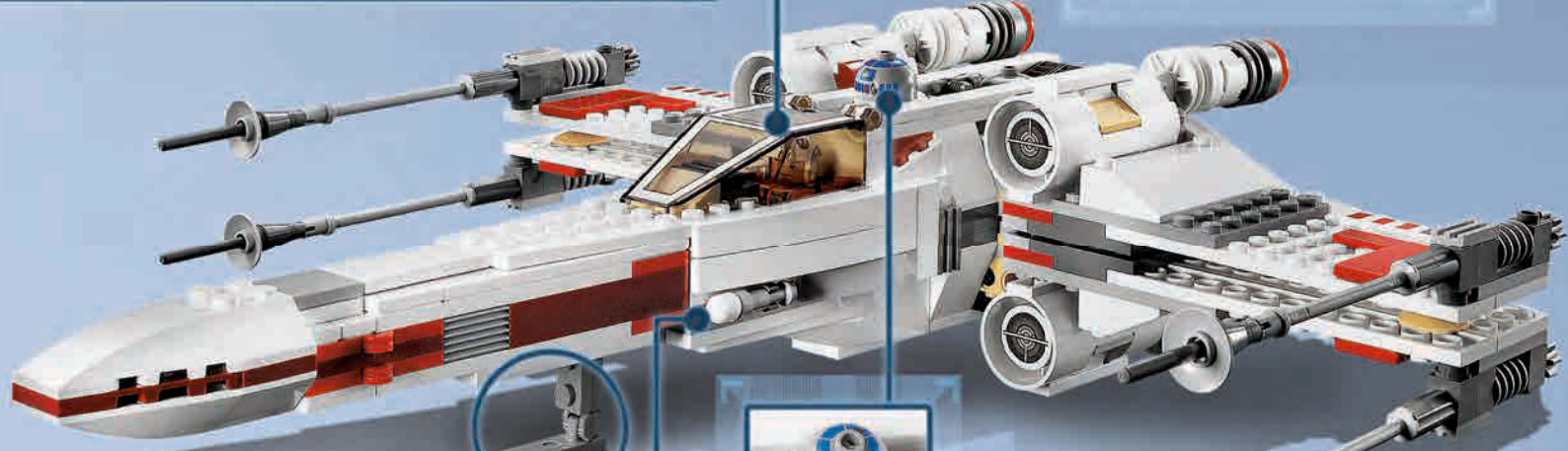



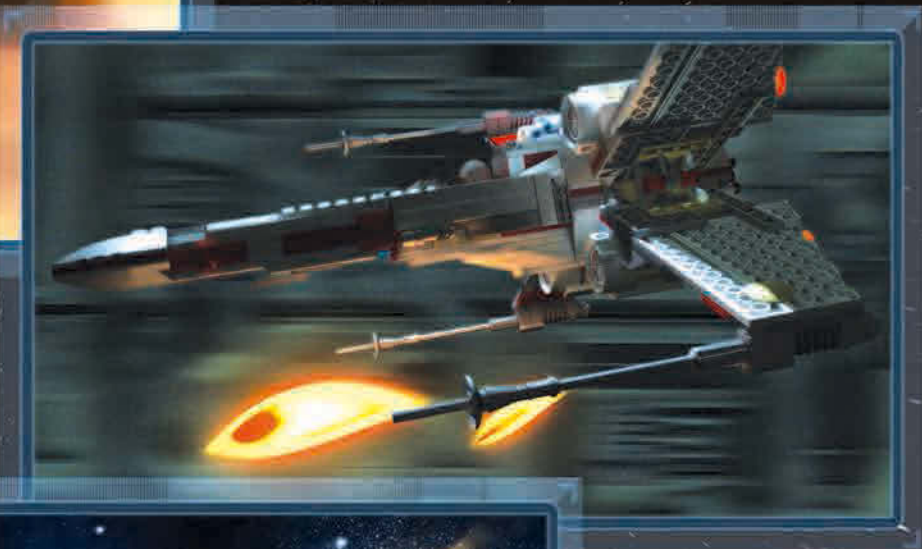





9493



9492



9491



9490



9489



9488



9488



9489



9490



9491



9492



9493



9488



9489



9490



9491



9492



9493



9488



9489



9490



9491



9492



9493



9488



9489



9490



9491



9492



9493



# ACE ASSAULT II



[starwars.LEGO.com](http://starwars.LEGO.com)





[www.LEGOclub.com](http://www.LEGOclub.com)



**FREE! GRATIS! GRATUIT!**



**LEGO® Club Magazine**



**LEGO® Club Email**

**SIGN UP ONLINE!**  
[www.LEGOclub.com](http://www.LEGOclub.com)

VISIT THE WORLD'S  
BIGGEST LEGO® SHOP!  
[www.LEGOshop.com](http://www.LEGOshop.com)

GO TO  
[www.LEGOclub.com](http://www.LEGOclub.com)

00800 5346 5555\*

1-866-534-6258 • 1-877-518-5346

US & Canada only

Canada seulement



\* Freephone. Mobile charges may apply. \* Numéro sans frais. Des frais peuvent s'appliquer avec les téléphones cellulaires. \* Gebührenfrei, Kosten für Anrufe aus Mobilfunknetzen können abweichen. \* Gratis telefoonnummer vanaf vaste lijn. \* Det er et gratis nummer, når du ringer fra fasttelefon. \* Det är gratis, när du ringer från en fast telefon. \* Numéro sans frais. Des frais peuvent s'appliquer avec les téléphones portables.

FLY11





# WIN!

Go to [www.LEGOsurvey.com/product](http://www.LEGOsurvey.com/product) to fill out a survey for a chance to win a cool LEGO® Product.

No purchase necessary.

Open to all residents where not prohibited.

 [www.LEGO.com](http://www.LEGO.com)



## [www.LEGOsurvey.com/product](http://www.LEGOsurvey.com/product)

### GEWINNE!

Nimm an der Umfrage auf [www.LEGOsurvey.com/product](http://www.LEGOsurvey.com/product) teil und hab die Chance ein cooles LEGO® Produkt zu gewinnen! Die Teilnahme am Gewinnspiel führt zu keinerlei Kaufverpflichtungen. Teilnahme in allen nicht ausgeschlossenen Ländern möglich.

### WIN!

Ga naar [www.LEGOsurvey.com/product](http://www.LEGOsurvey.com/product), vul een enquêteformulier in en maak kans op een cool LEGO® product. Geen aankoopverplichting. Iedereen mag deelnemen, uitgezonderd ingezetenden van landen waar een enquêteverbod geldt.

### GAGNE!

Visite [www.LEGOsurvey.com/product](http://www.LEGOsurvey.com/product) pour répondre à un questionnaire et avoir une chance de gagner un produit LEGO® très cool! Aucune obligation d'achat. Ouvert à tous les résidents des pays autorisés.

### 当てよう!

[www.LEGOsurvey.com/product](http://www.LEGOsurvey.com/product) にアクセスして、アンケートにご記入ください。当選者にはレゴ製品を差し上げます。お買い上げの必要はありません。禁止されていない限り、すべての皆様にご利用いただけます。