



# STAR WAR

TM



9515





2x



4x

# 68

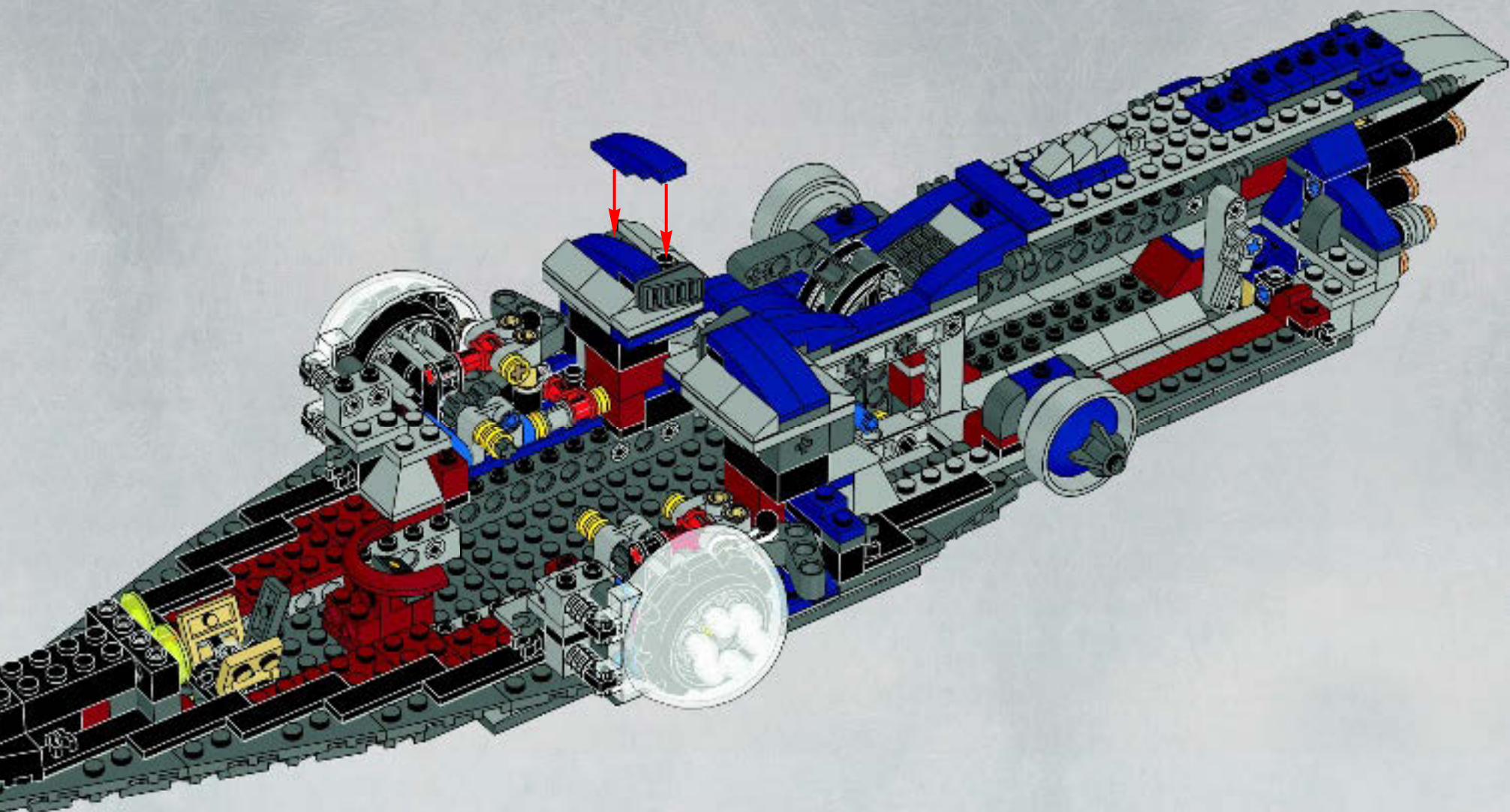

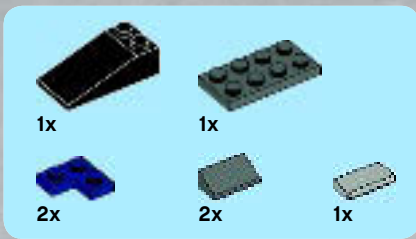

# 69

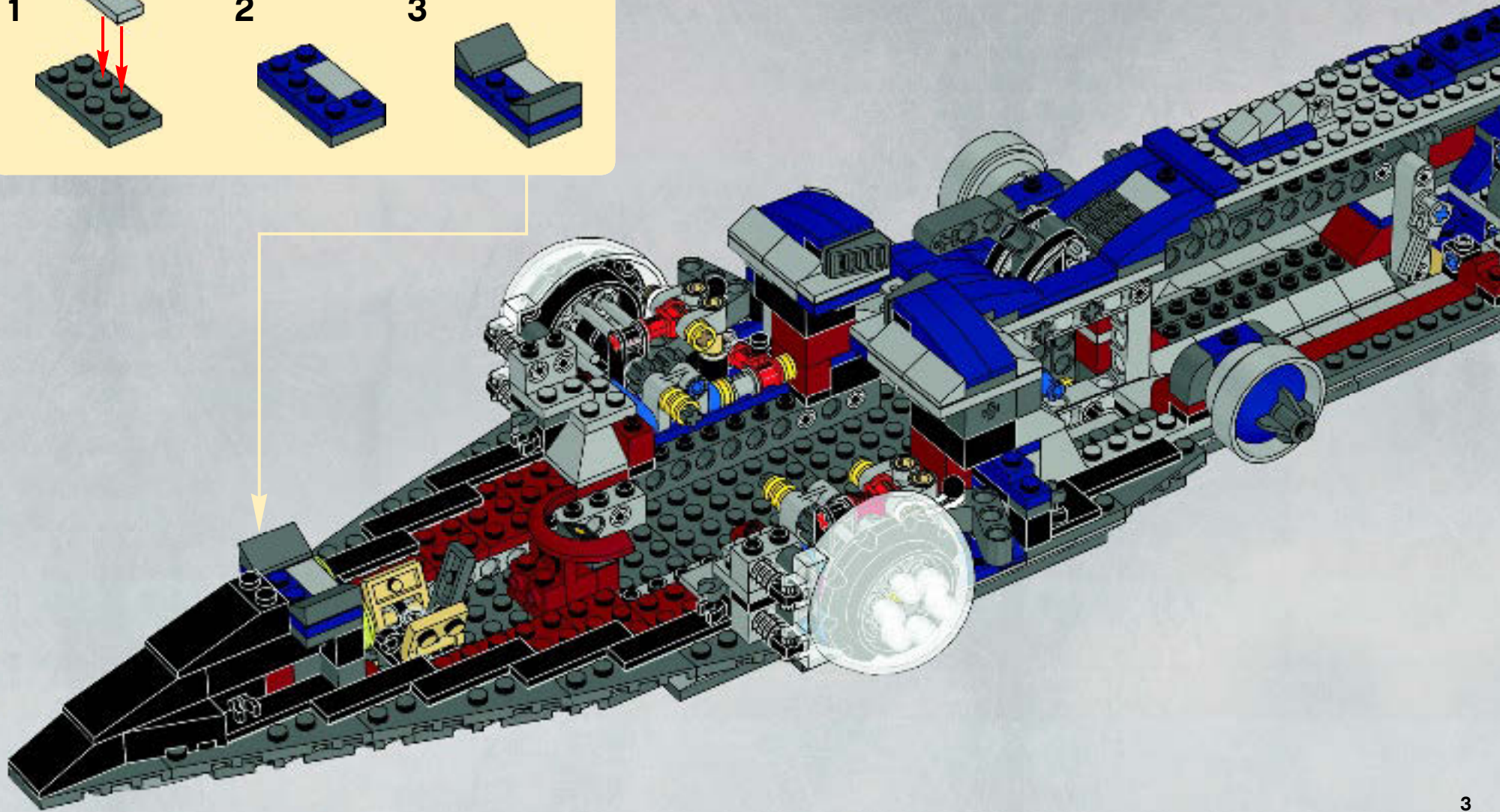
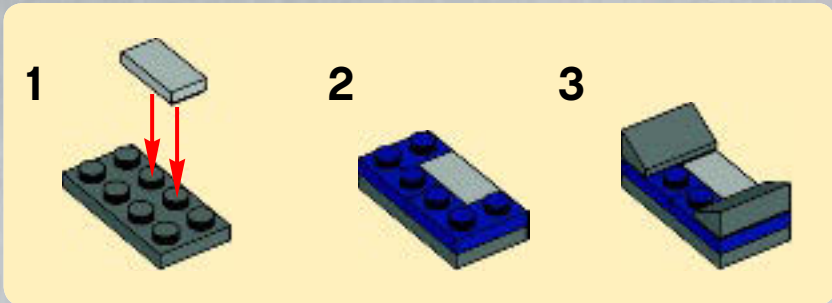

1x

2x

1x

# 70

1

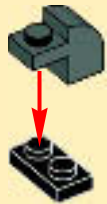

2

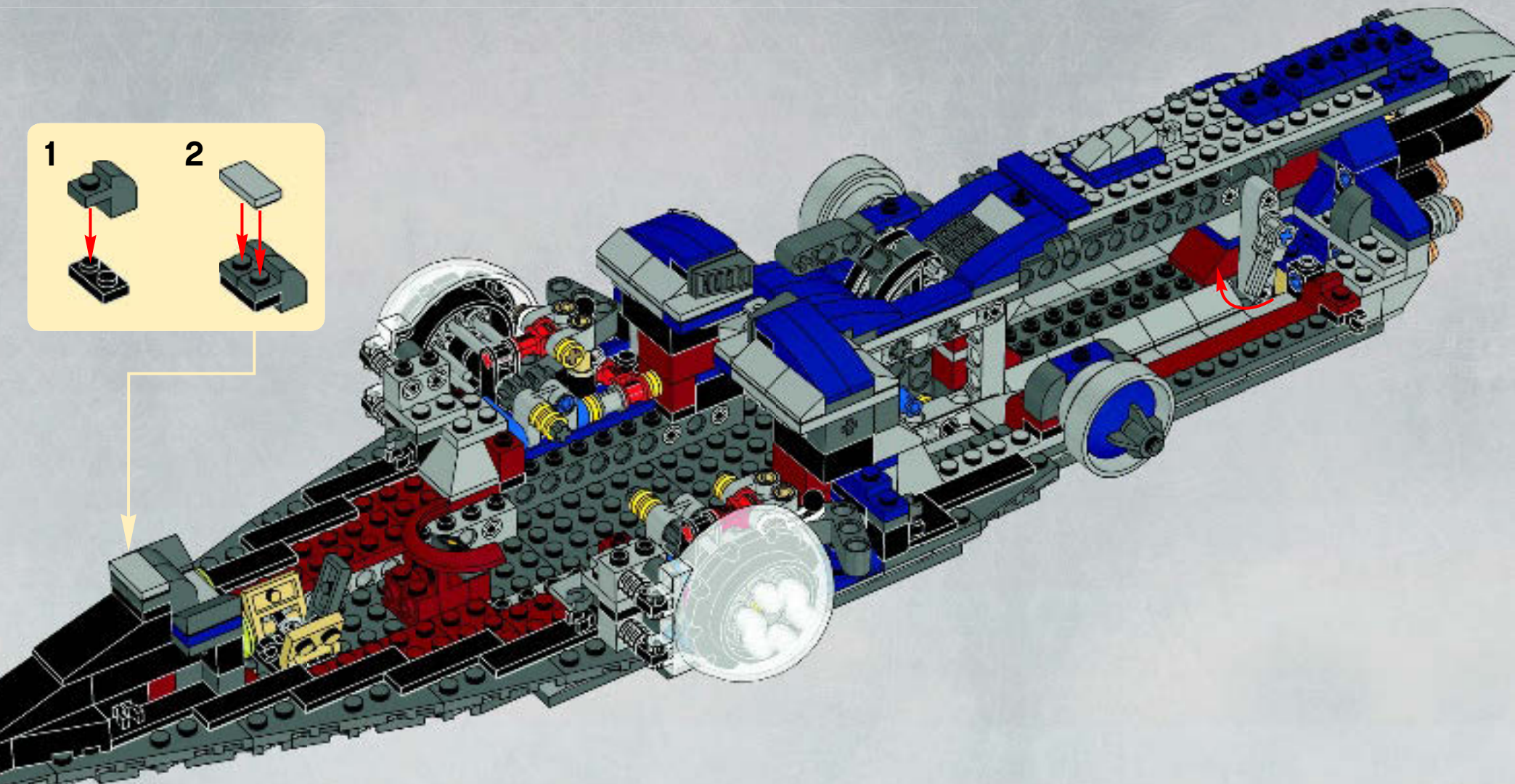
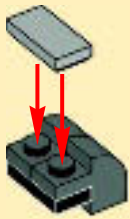



1

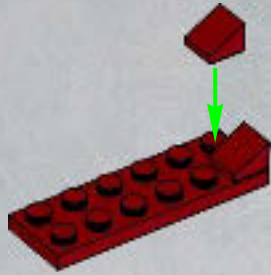

2

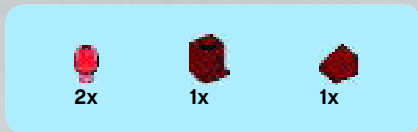

3

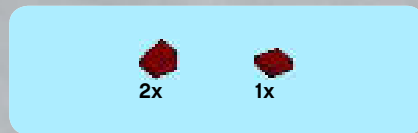

4

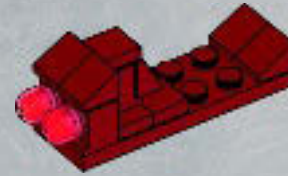

2x

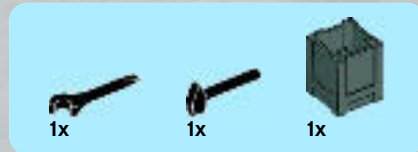

5

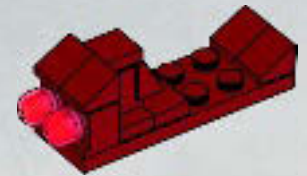
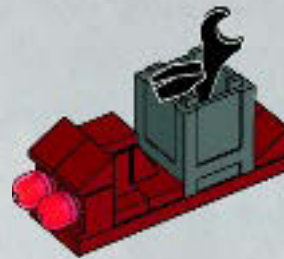

71

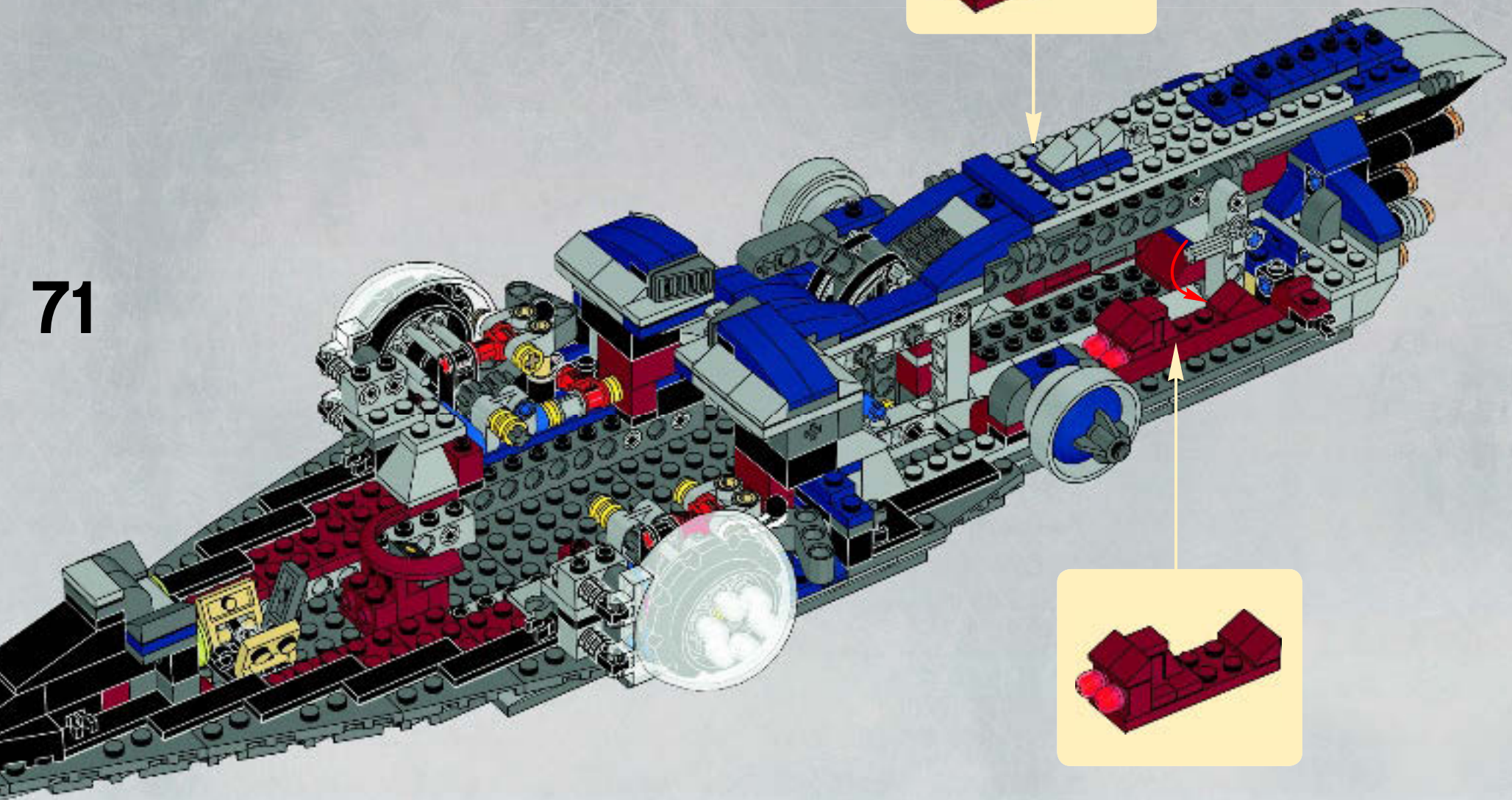

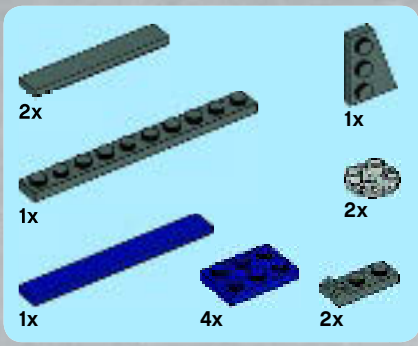

72

1

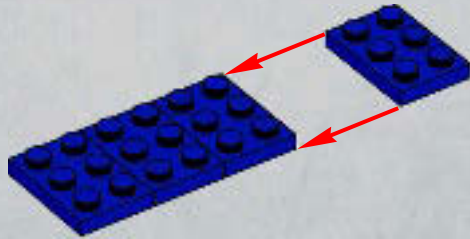

2



3

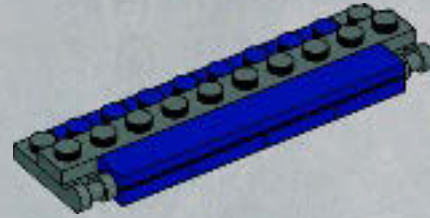

4

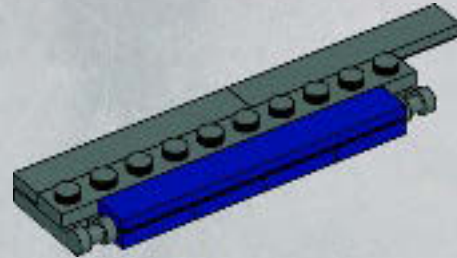

5



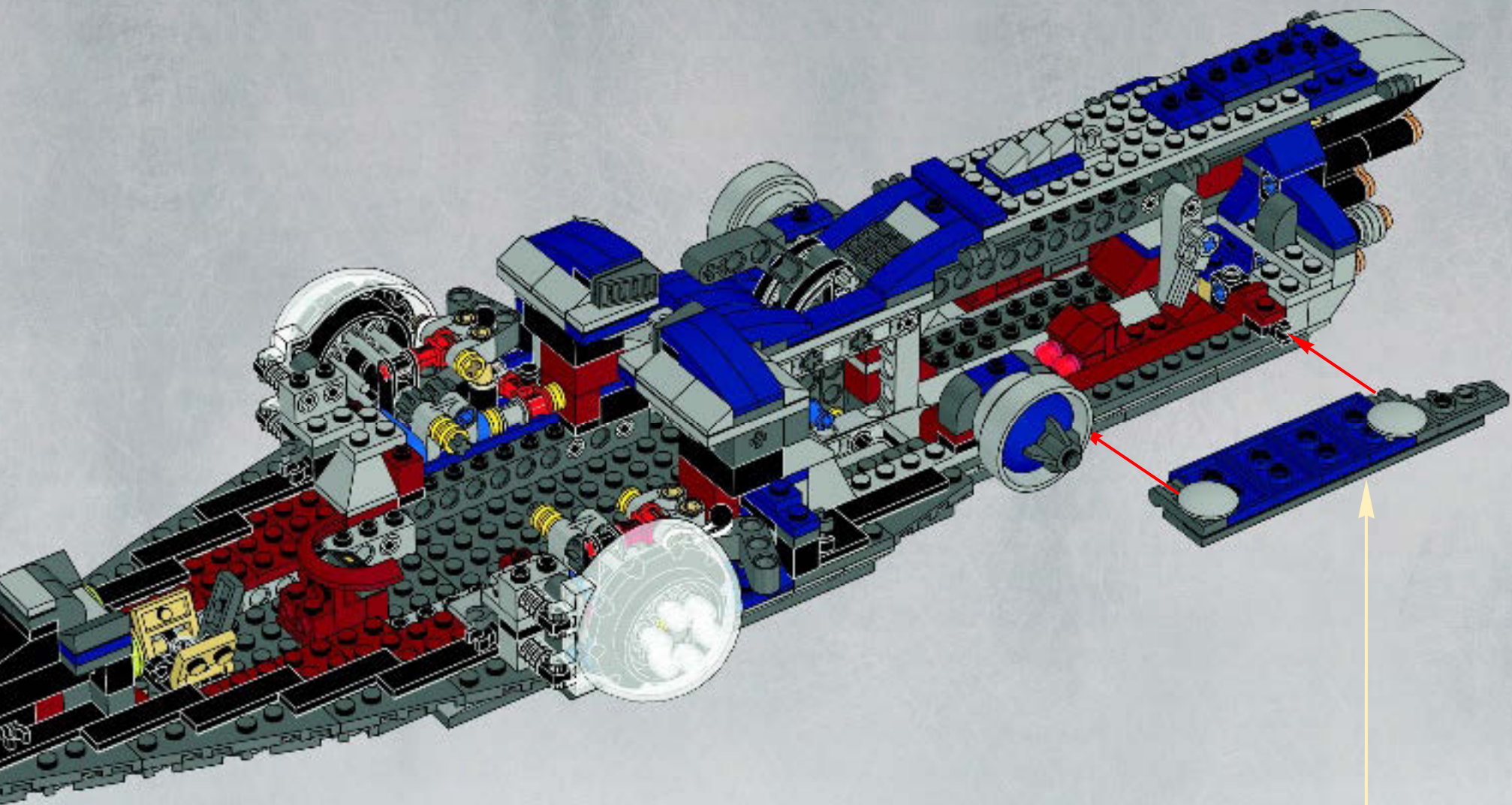



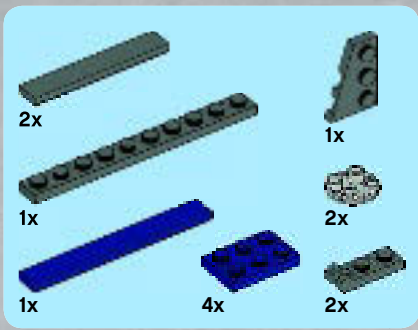

# 73

1

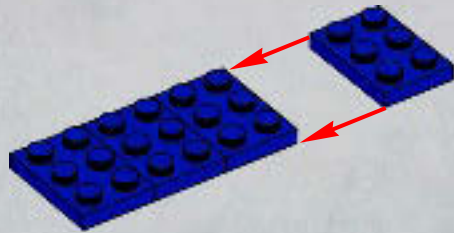

2



3

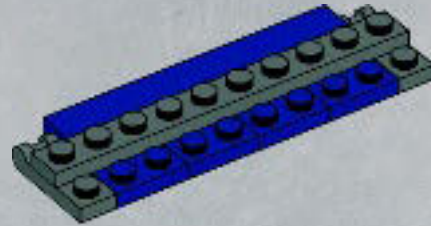

4

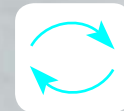
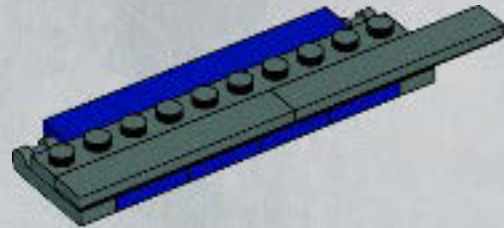

5



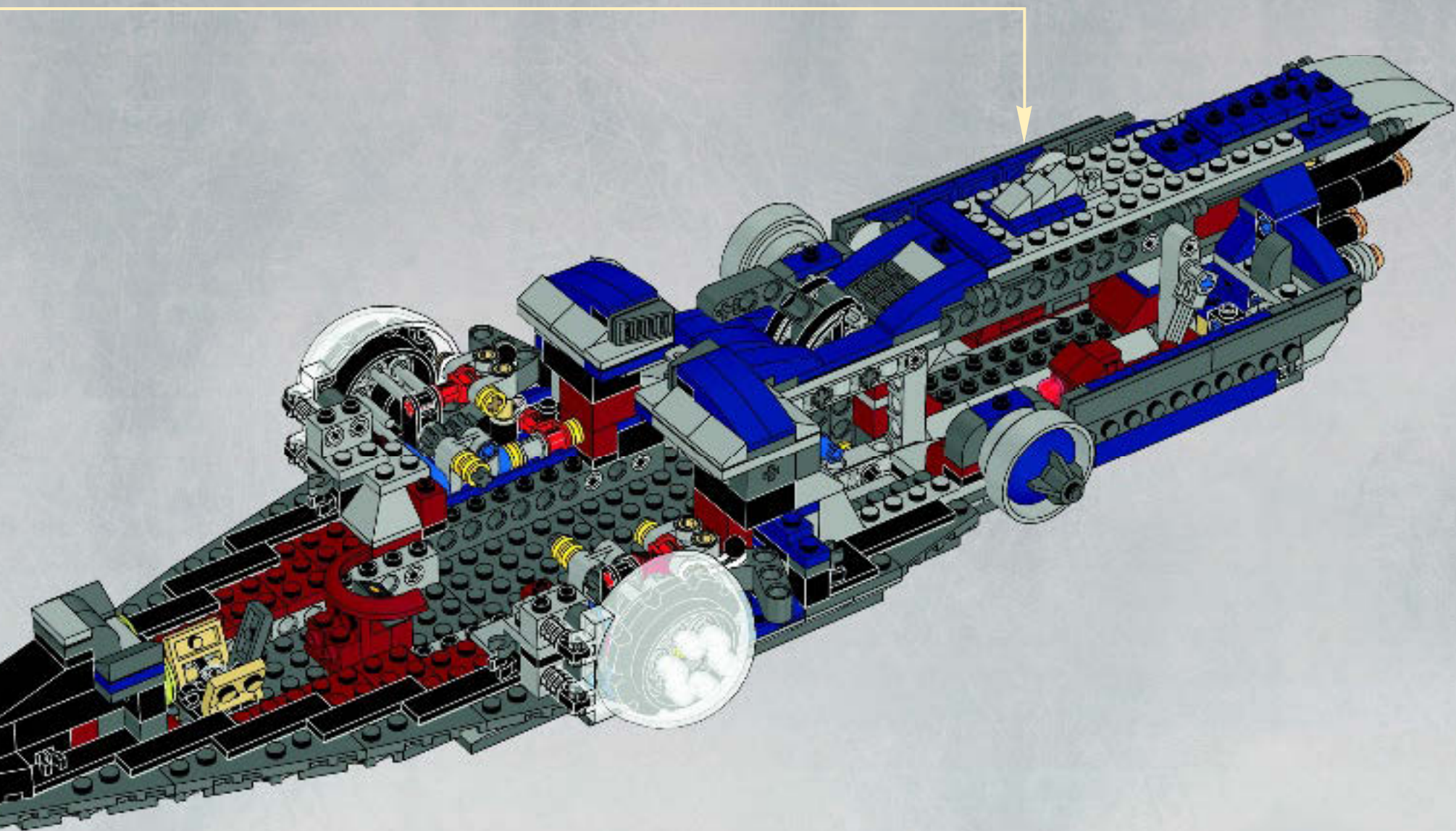

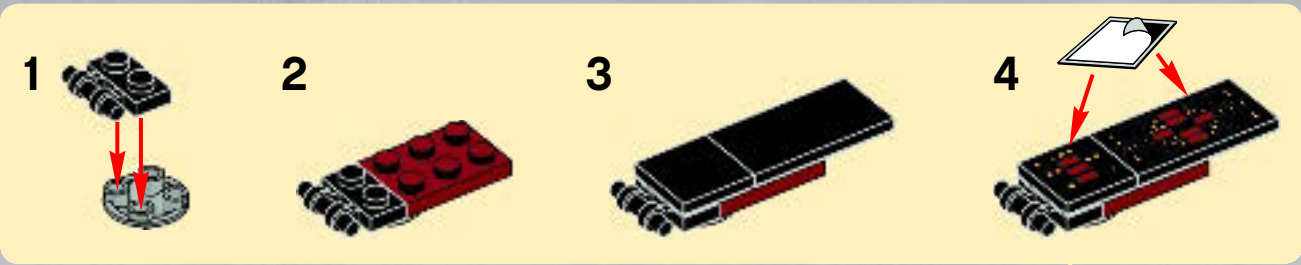
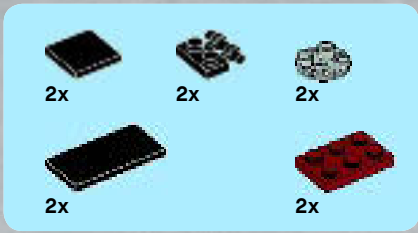

74

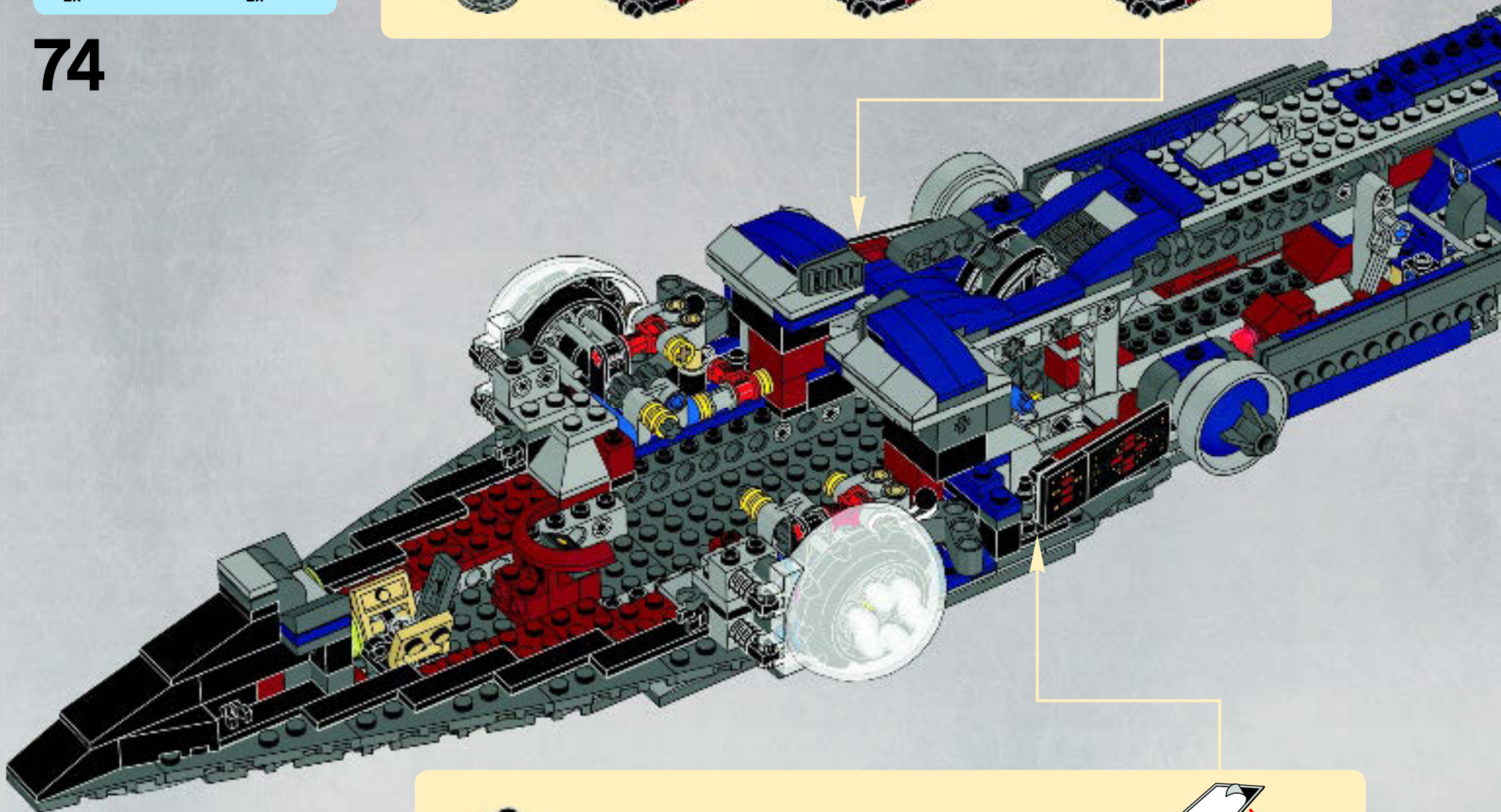

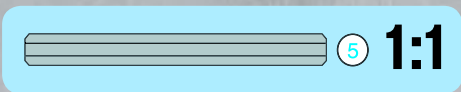
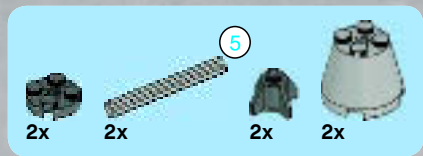

# 75

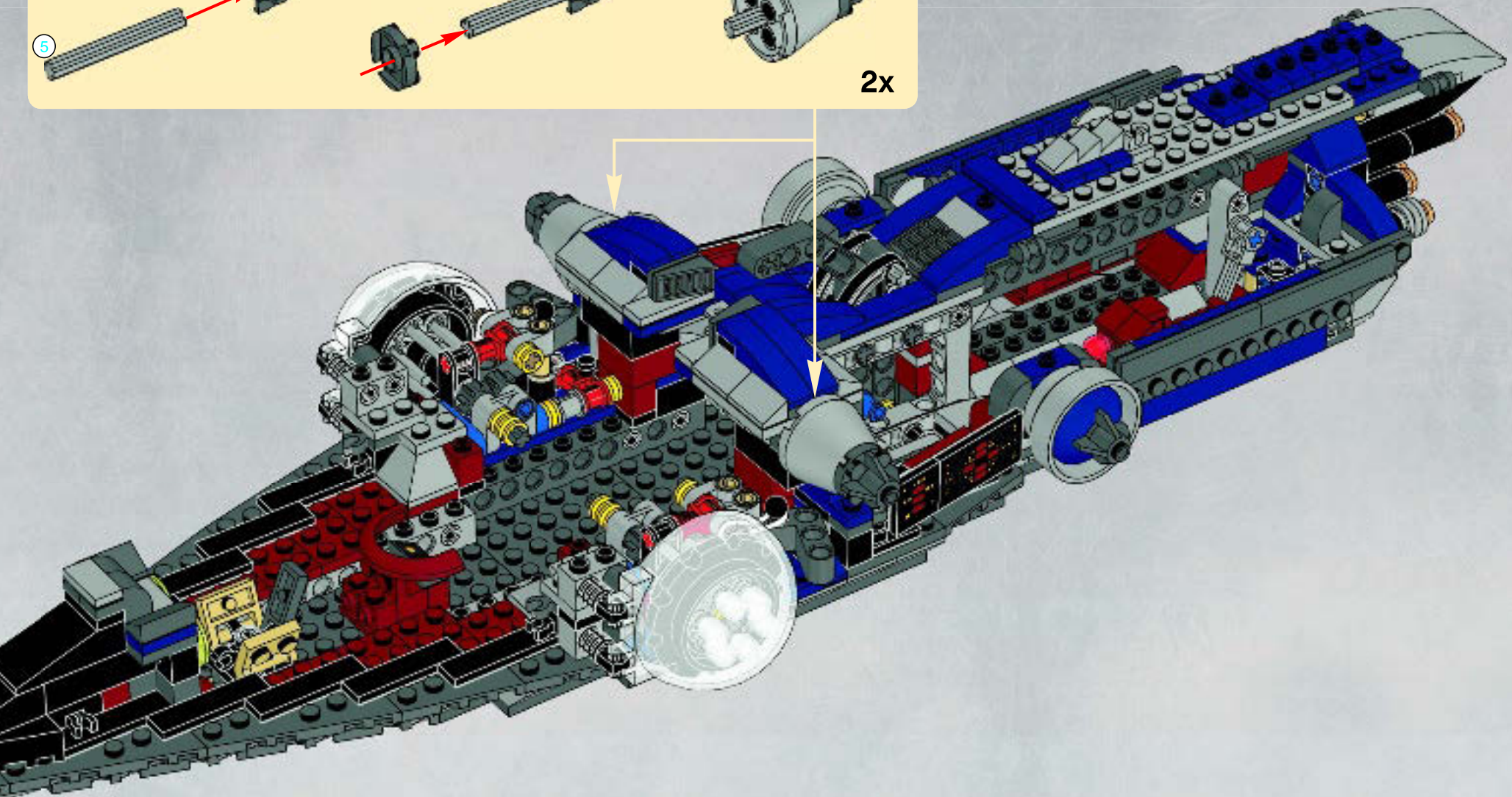
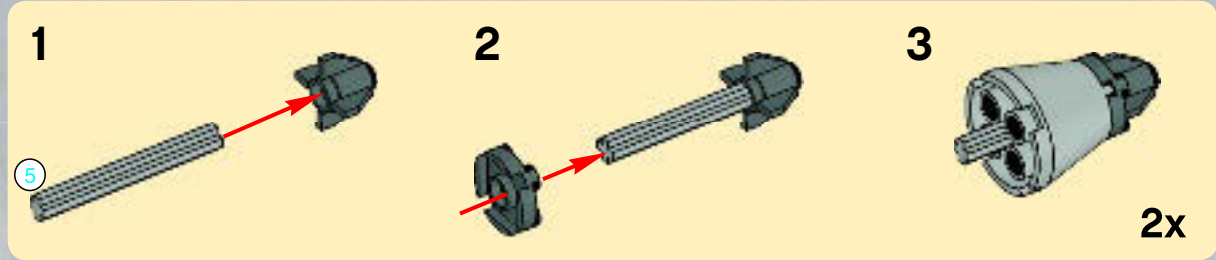

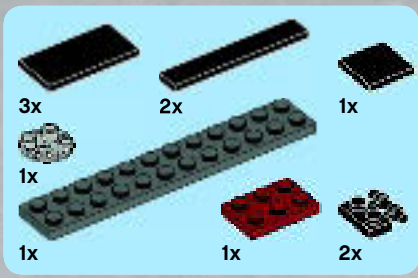

# 76

1

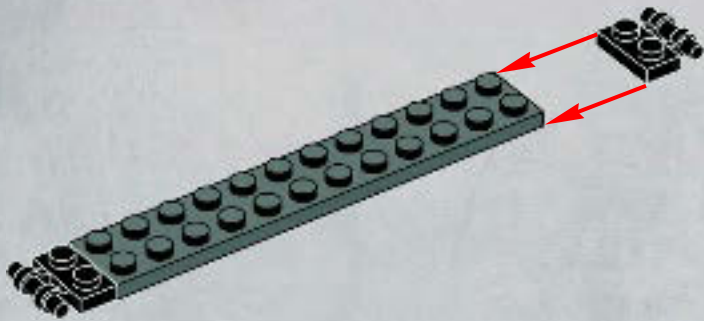

2

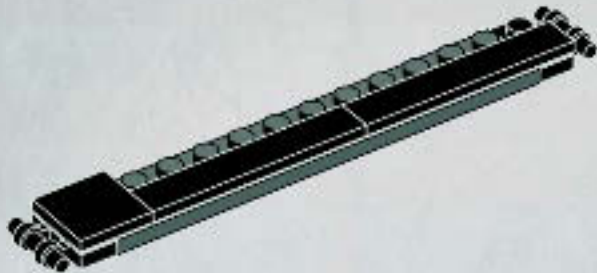

3

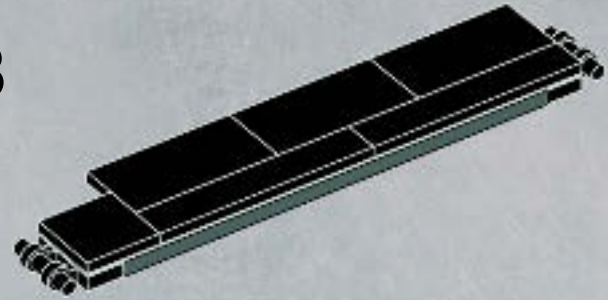

4

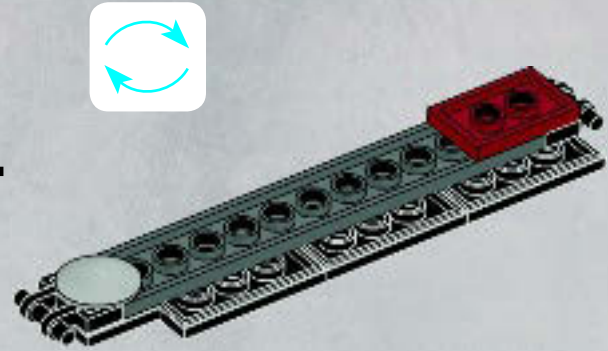

5

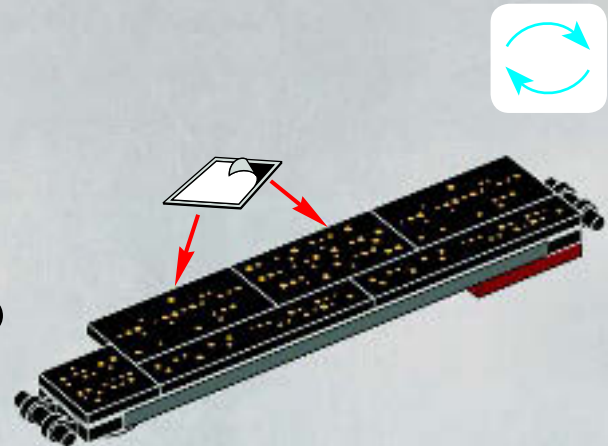

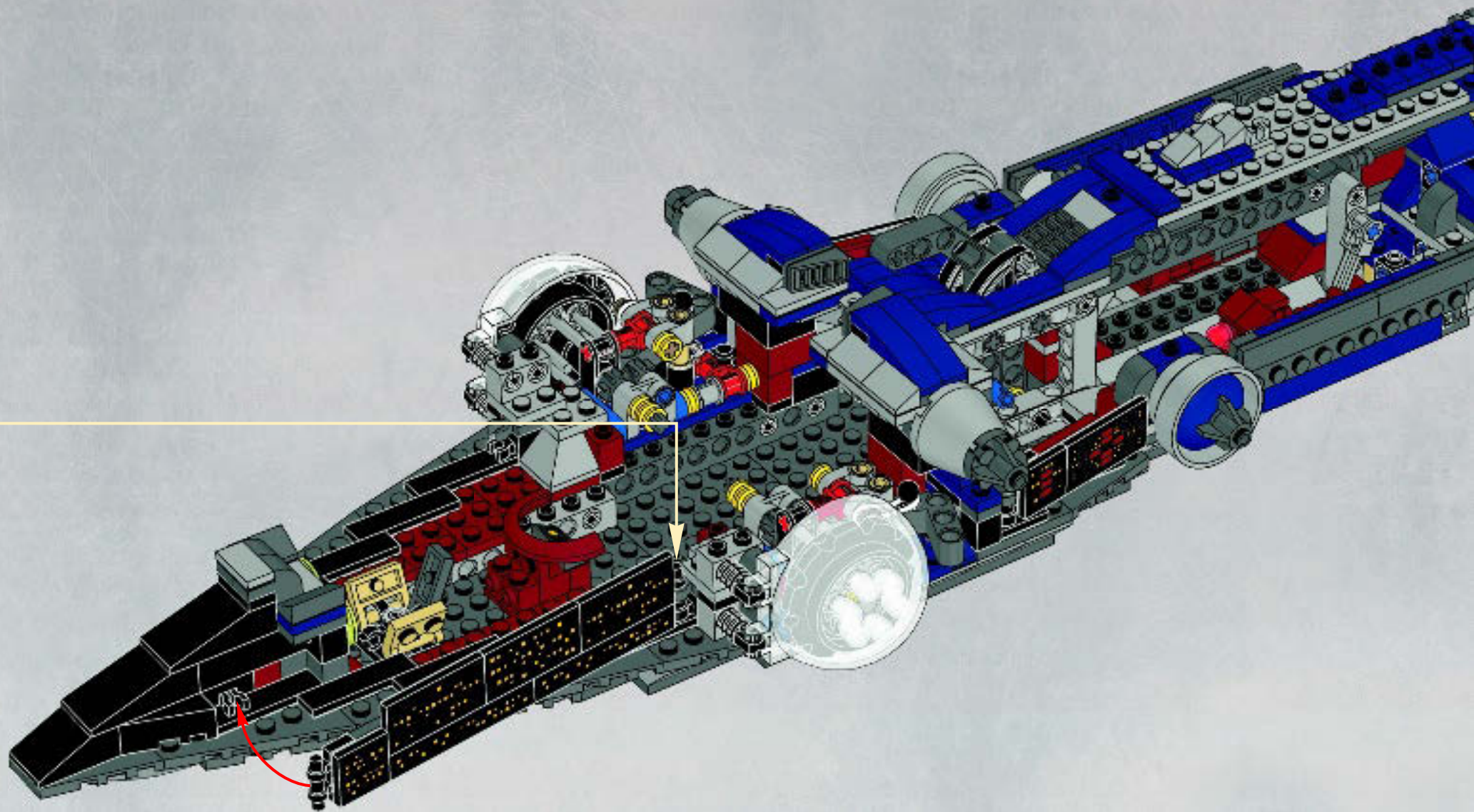

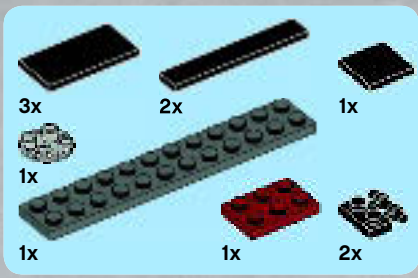

77

1

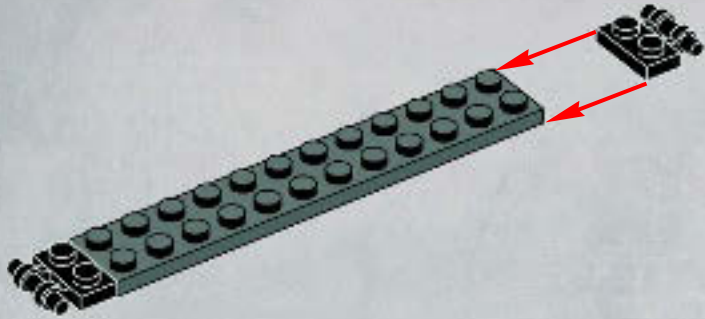

2

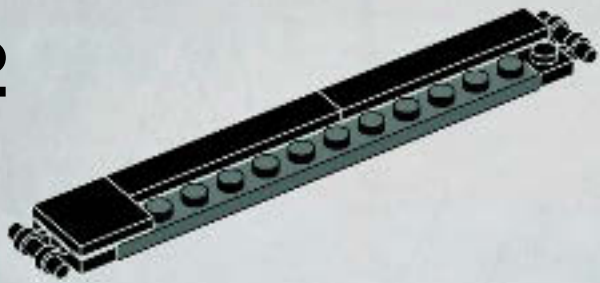

3

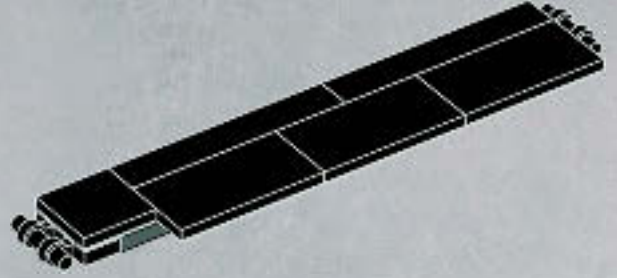

4

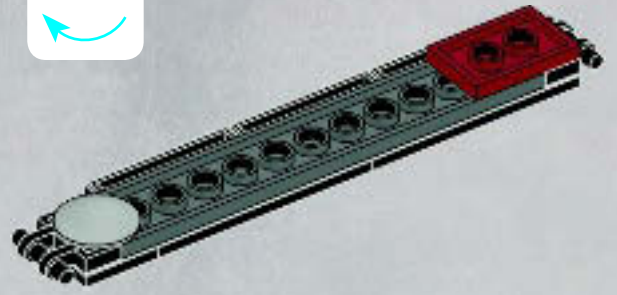

5

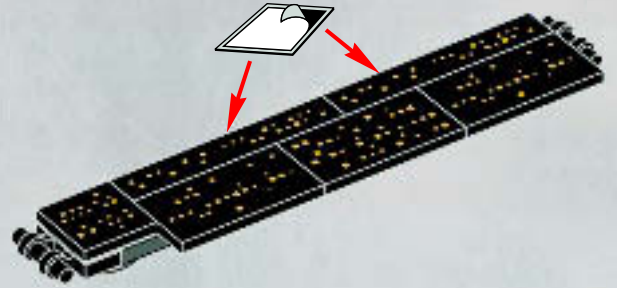

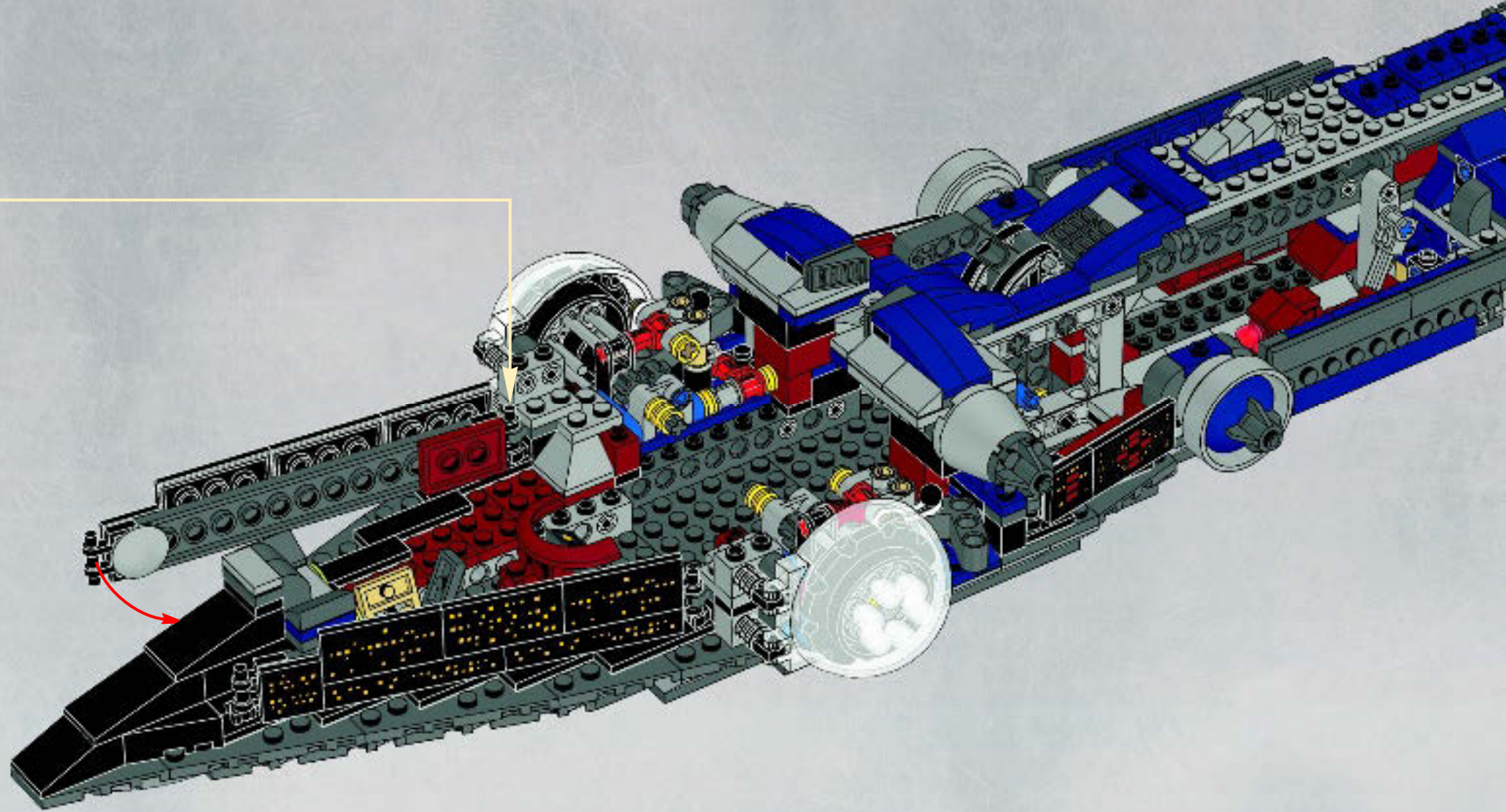





6

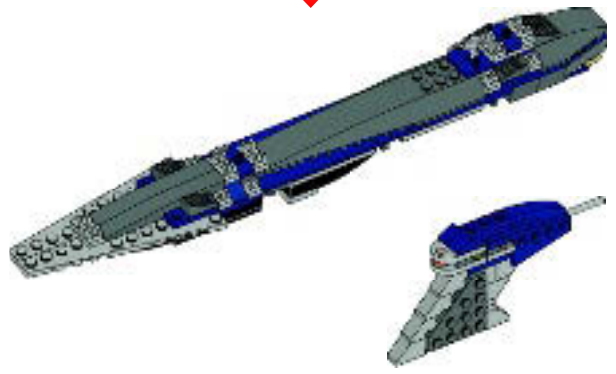

2x

1

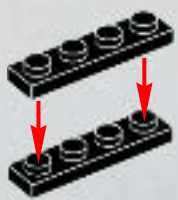

1x

2

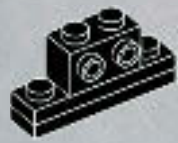

2x

3

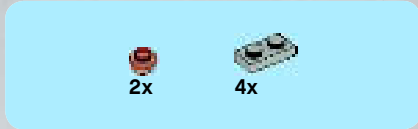
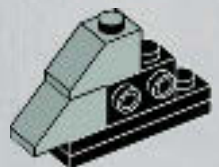

2x

4x

4

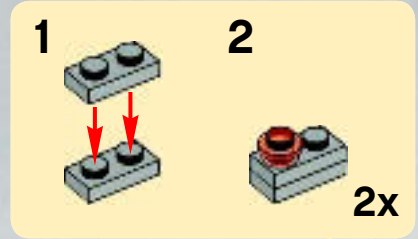

1

2

2x

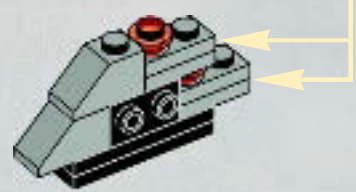



1x



2x

5

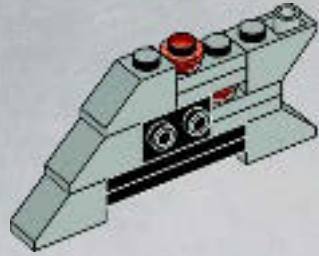

1x



1x



1x

6

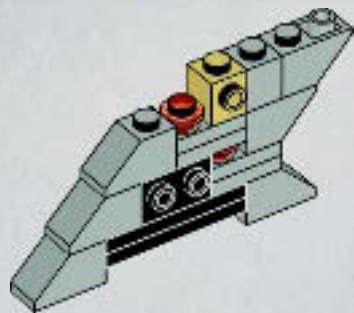

1x



1x

7

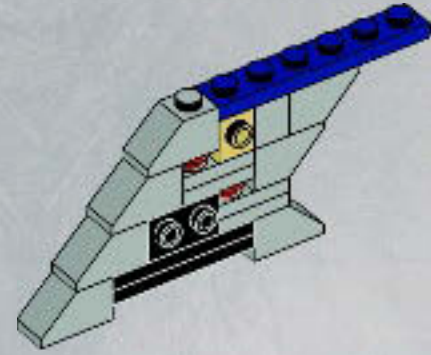

2x



2x

8

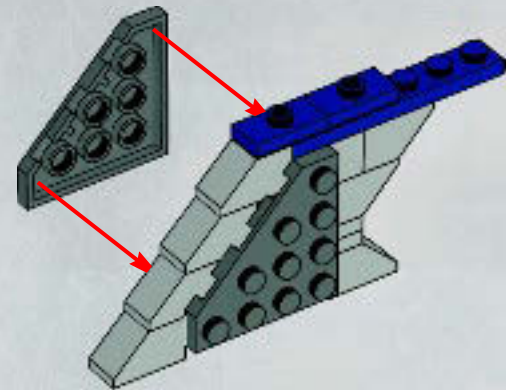

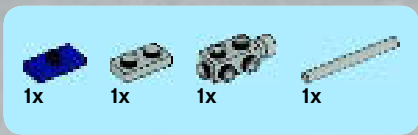

9

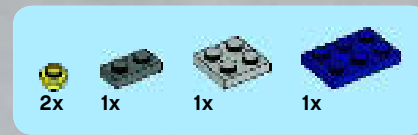
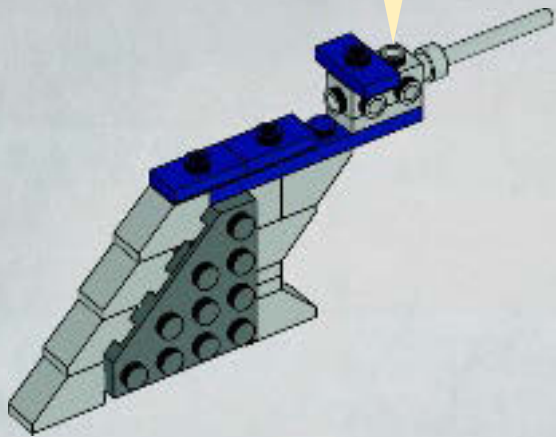
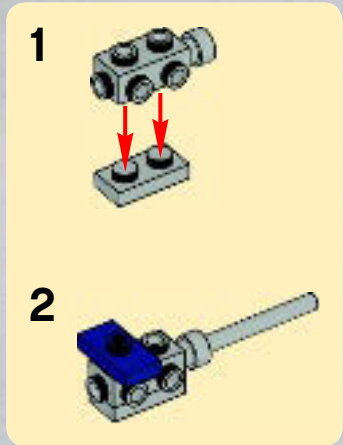

10

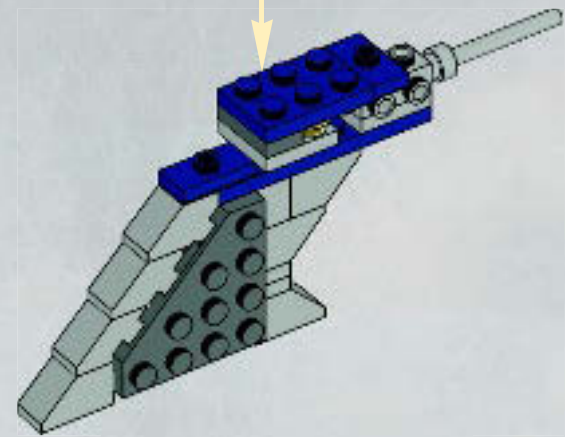



# 11

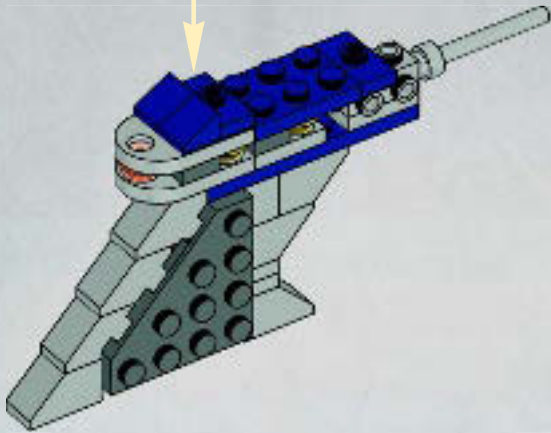
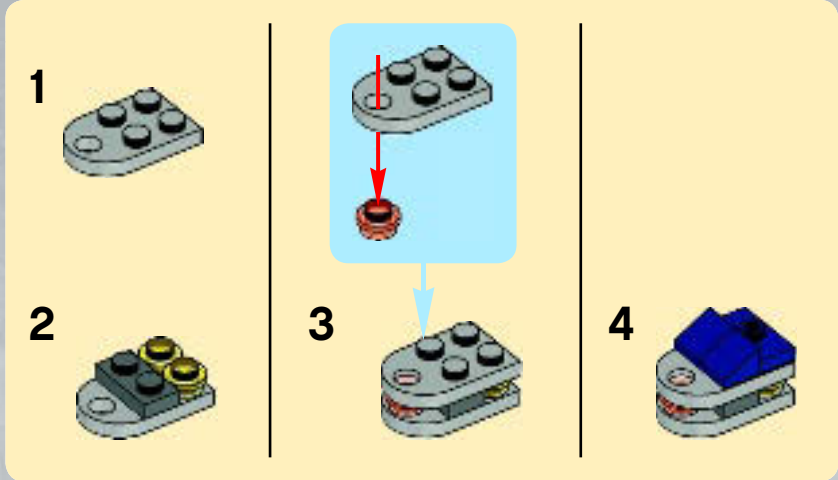

# 12

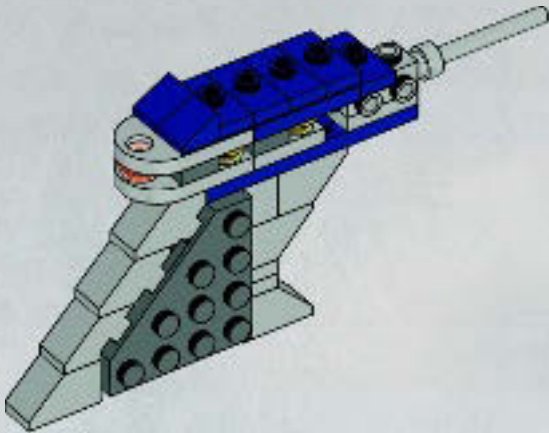

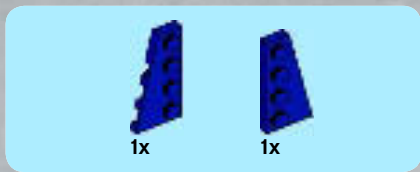

13

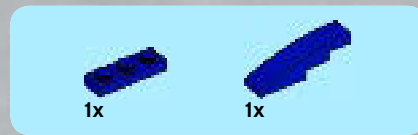
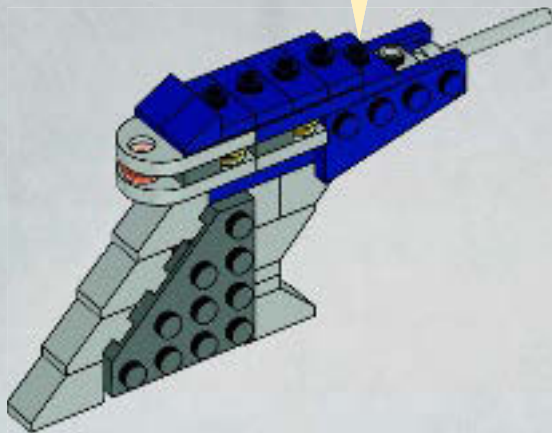

14

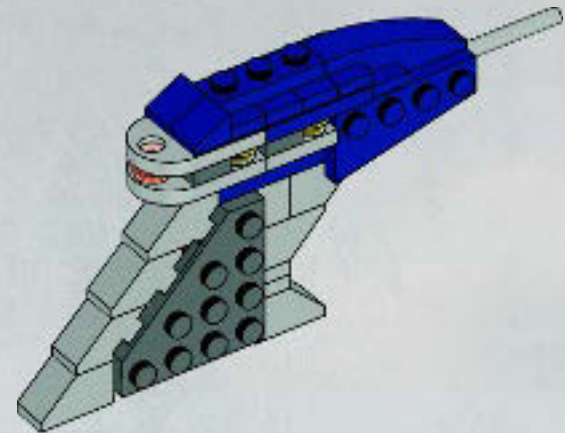

78

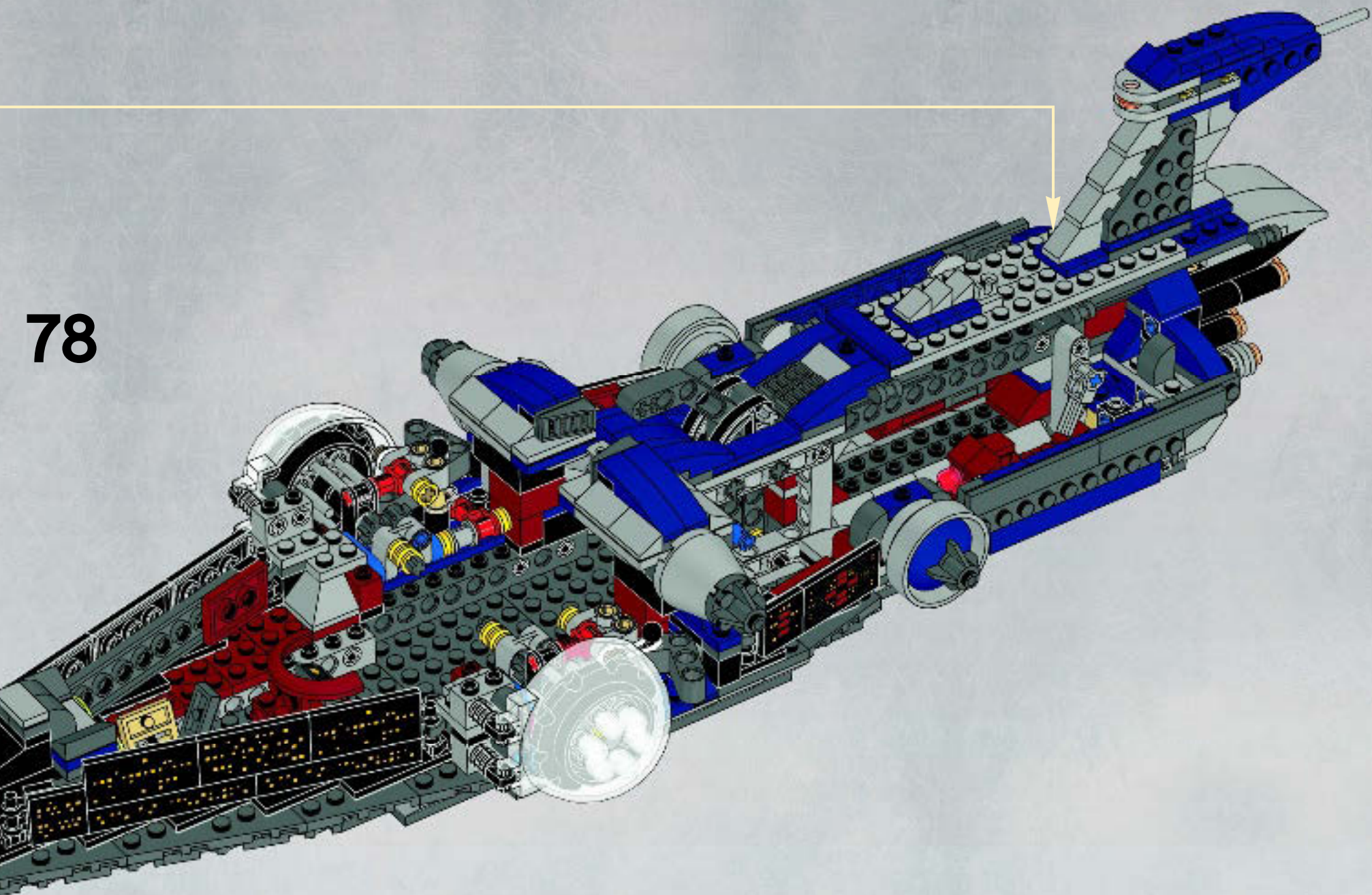

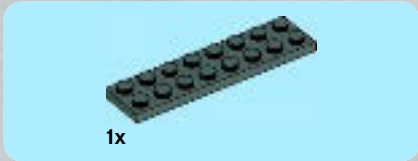
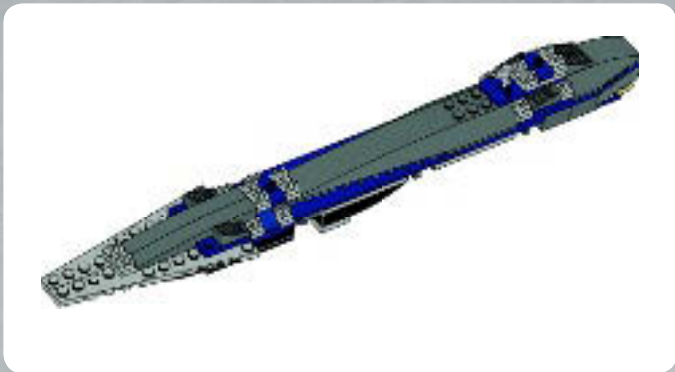

1x

1

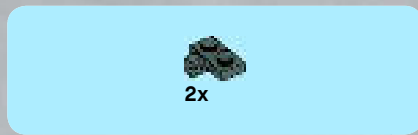

2x

2

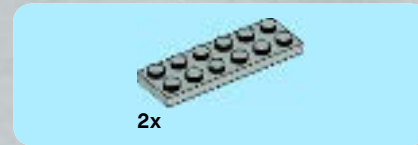
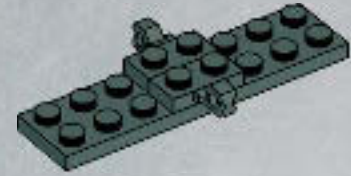

2x

3

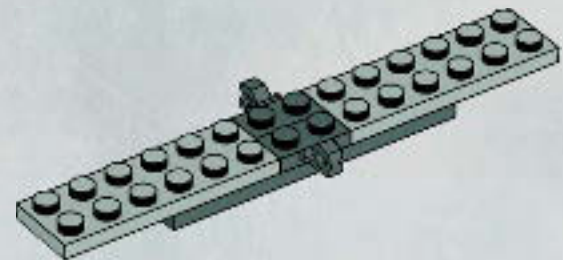

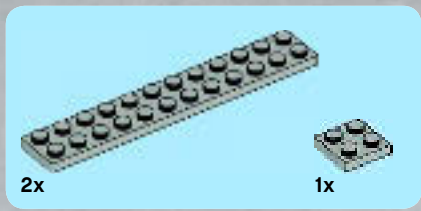

4

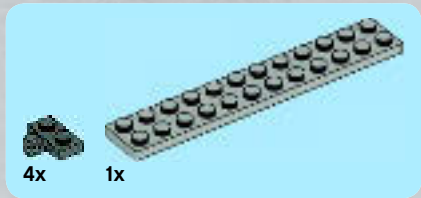
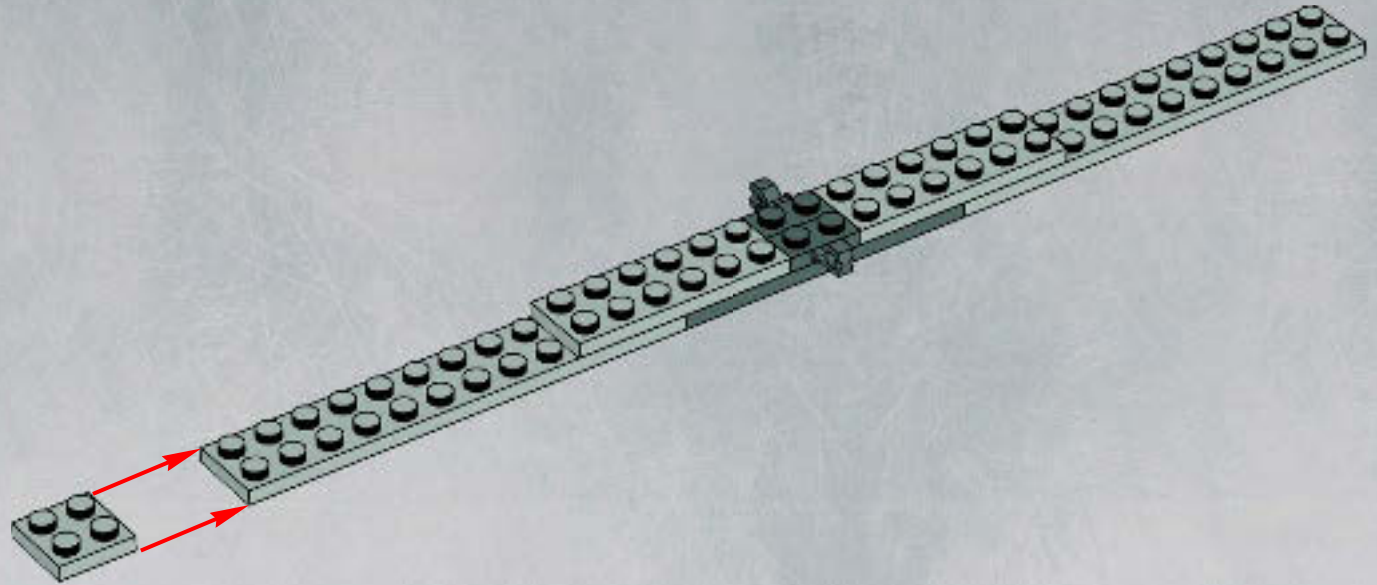

5

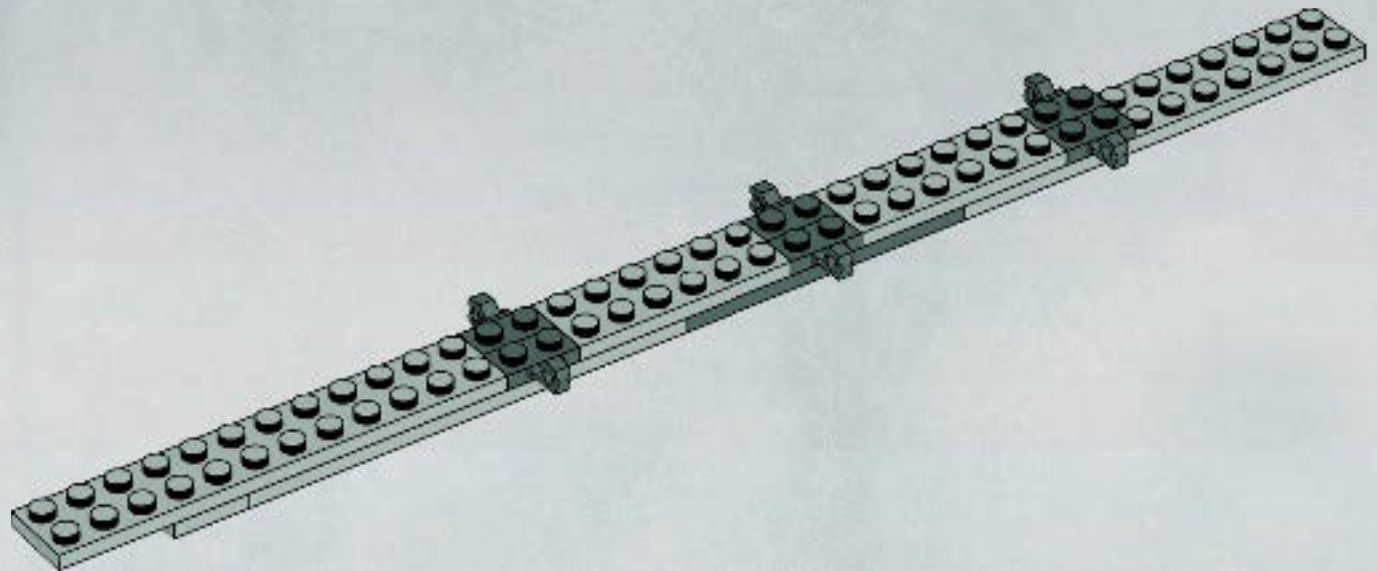



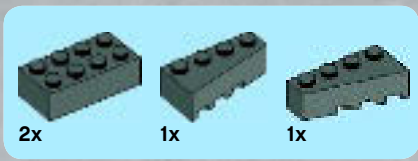

6

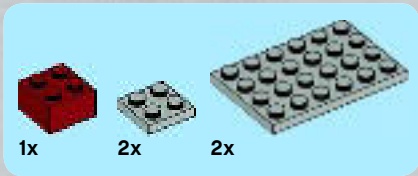
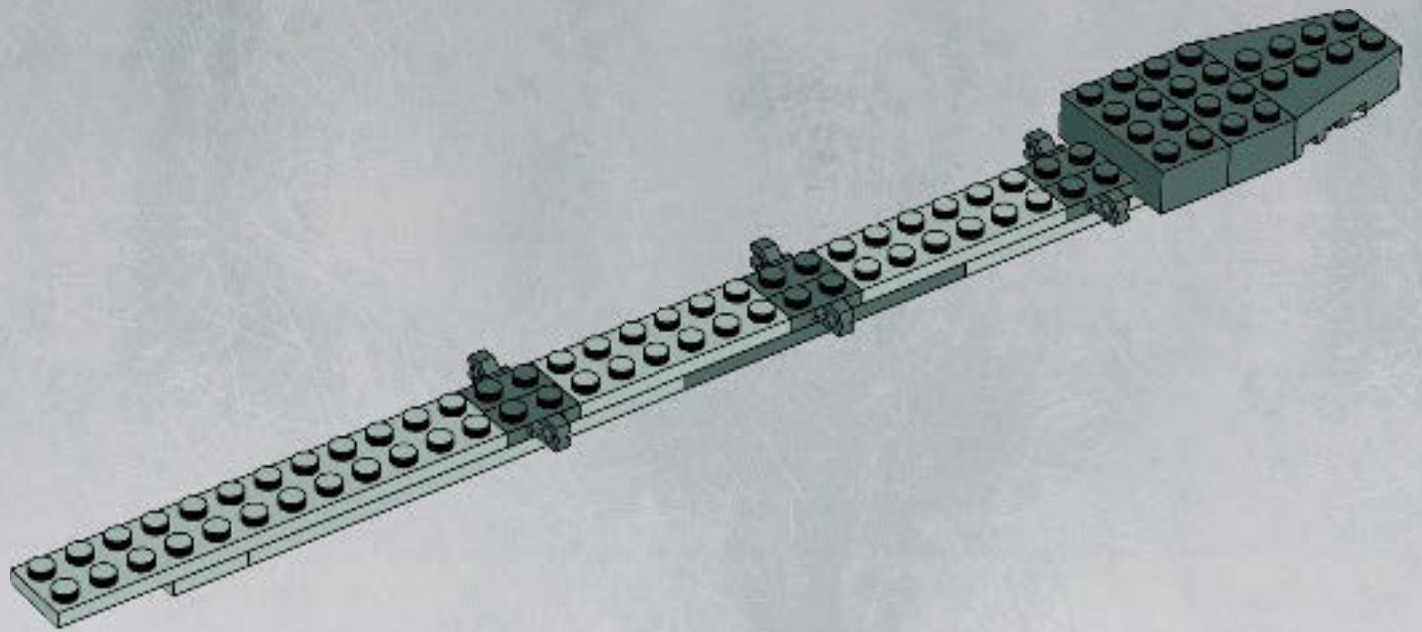

7

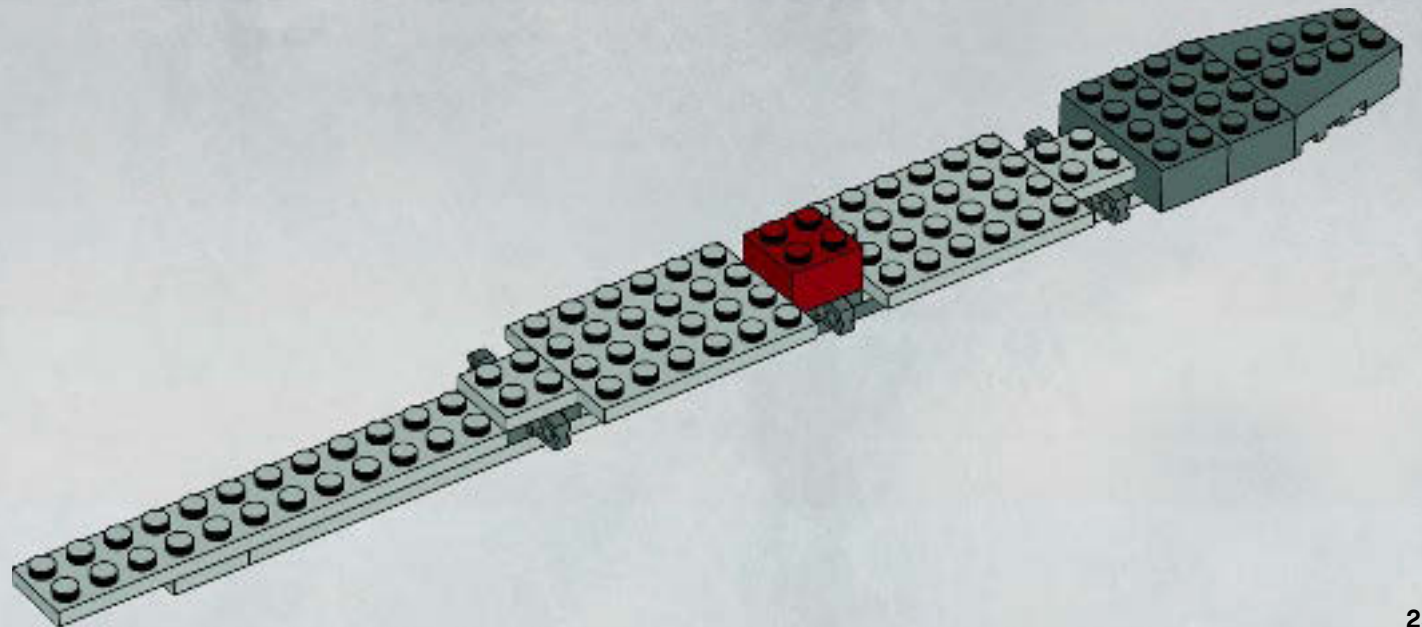

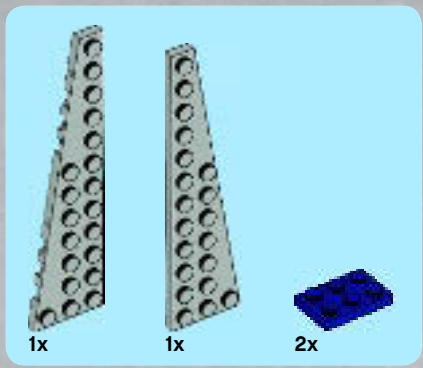

8

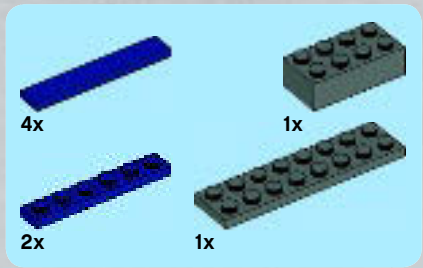
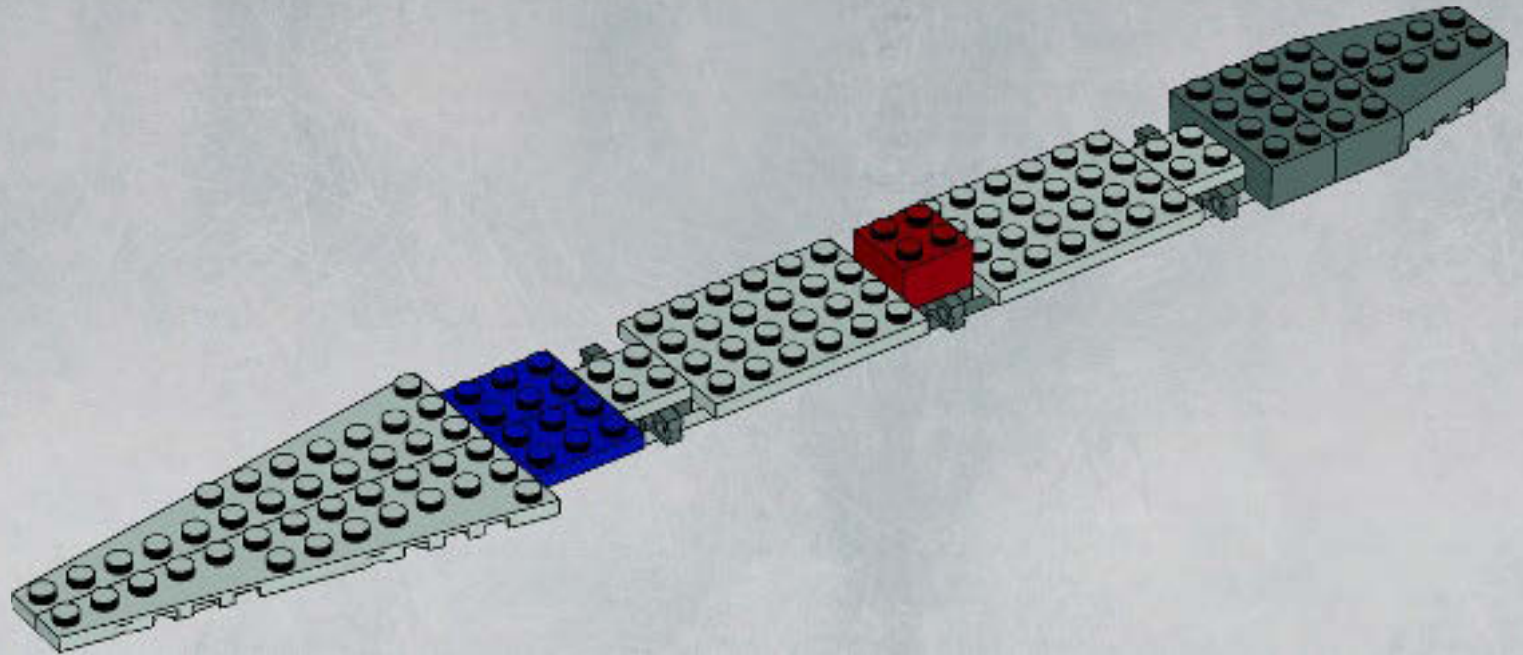

9

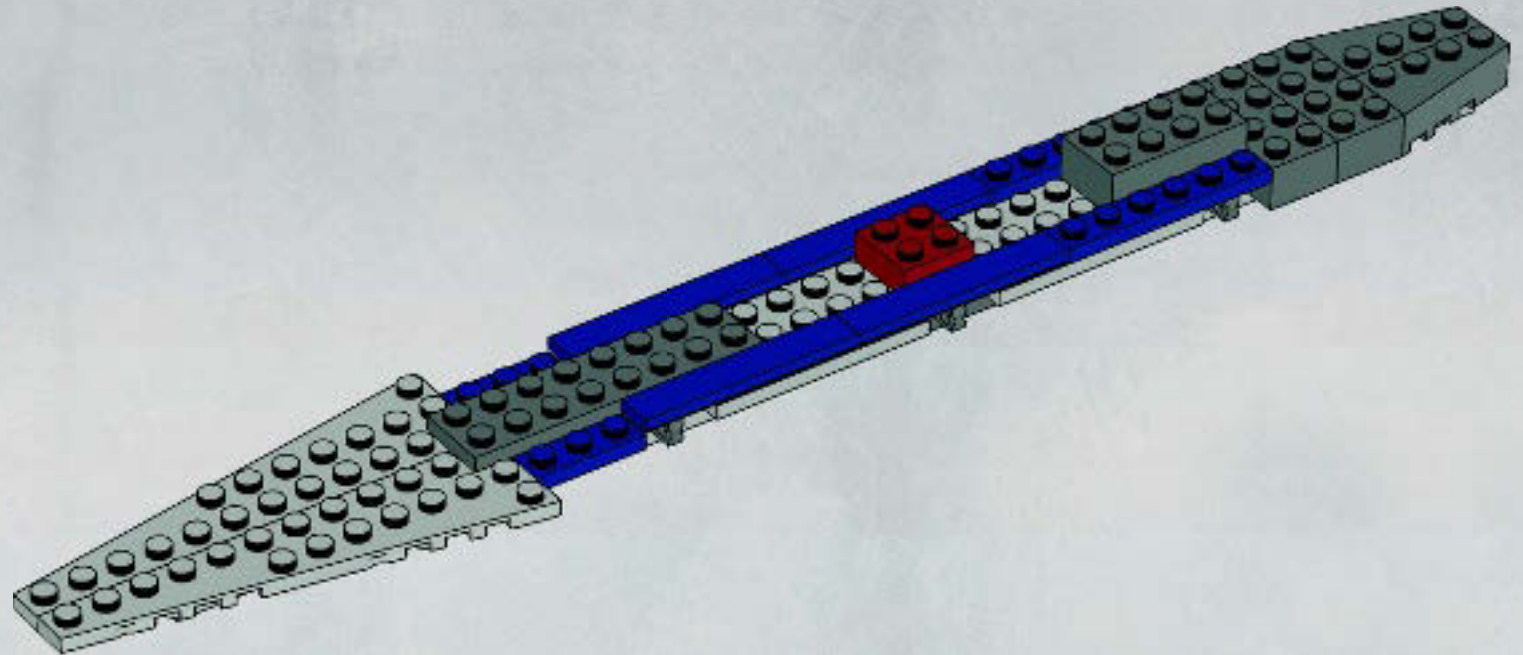

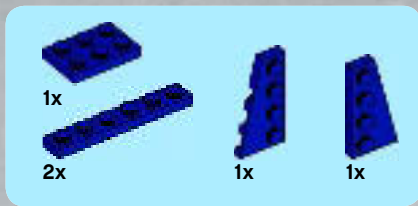

10

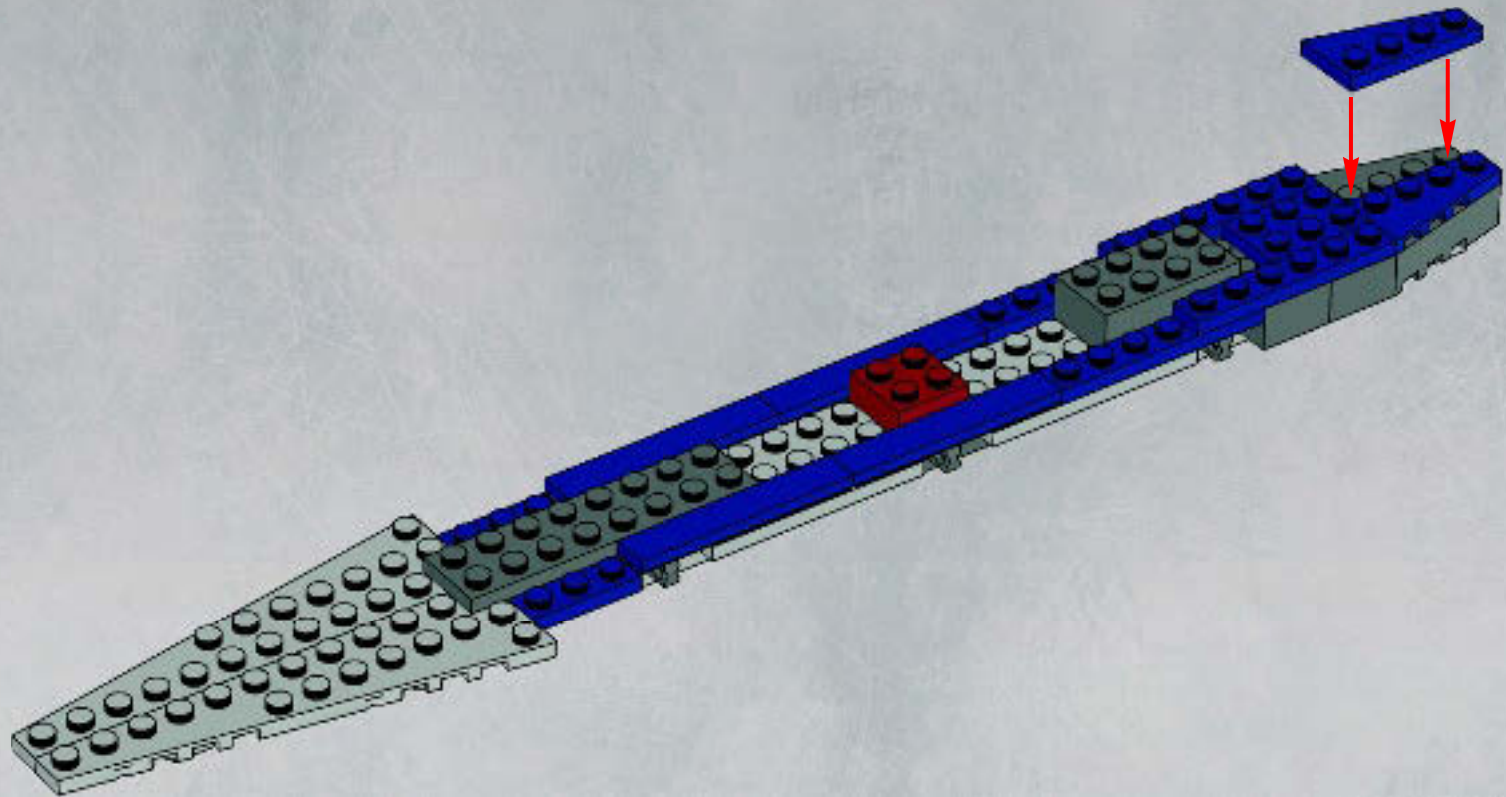

11

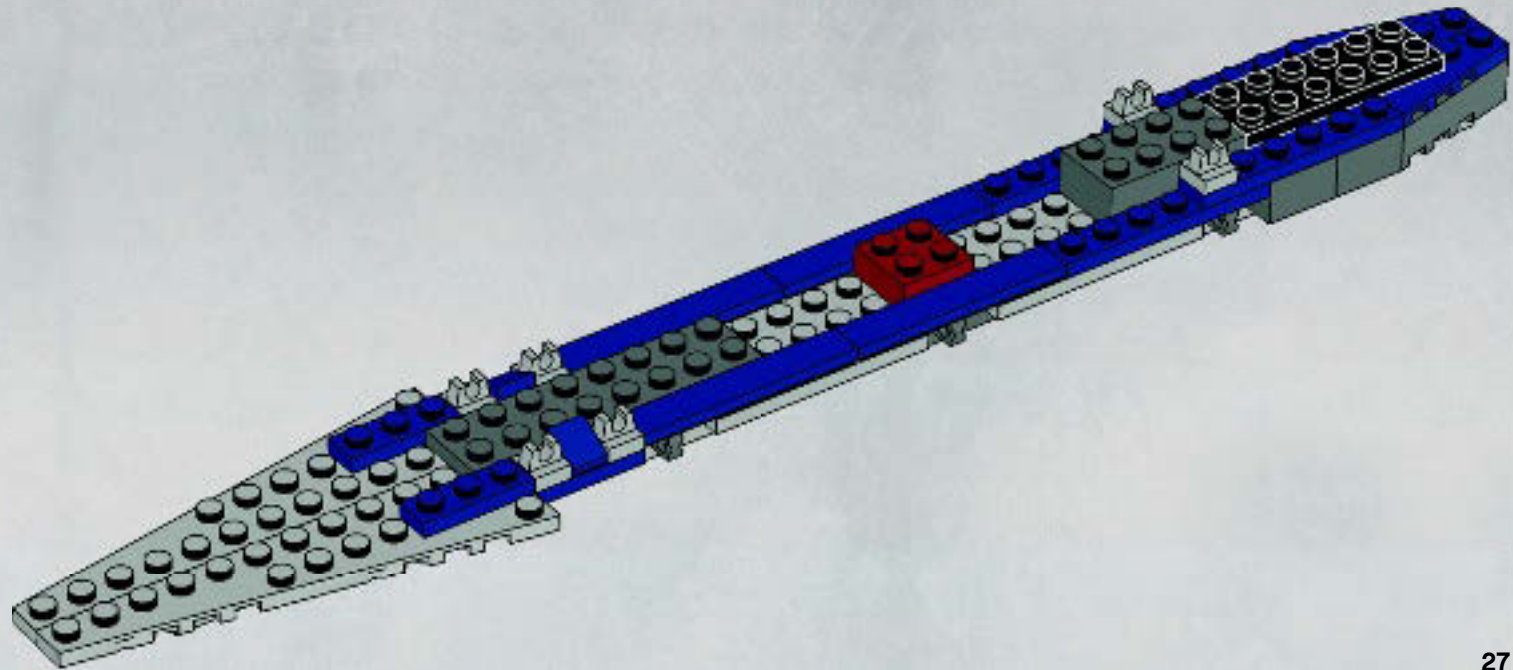

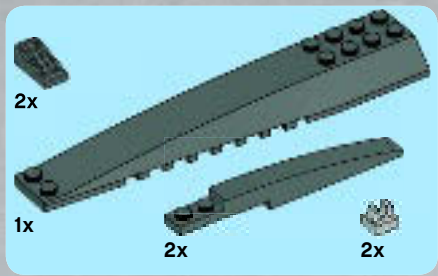

12

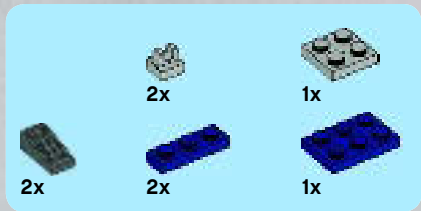
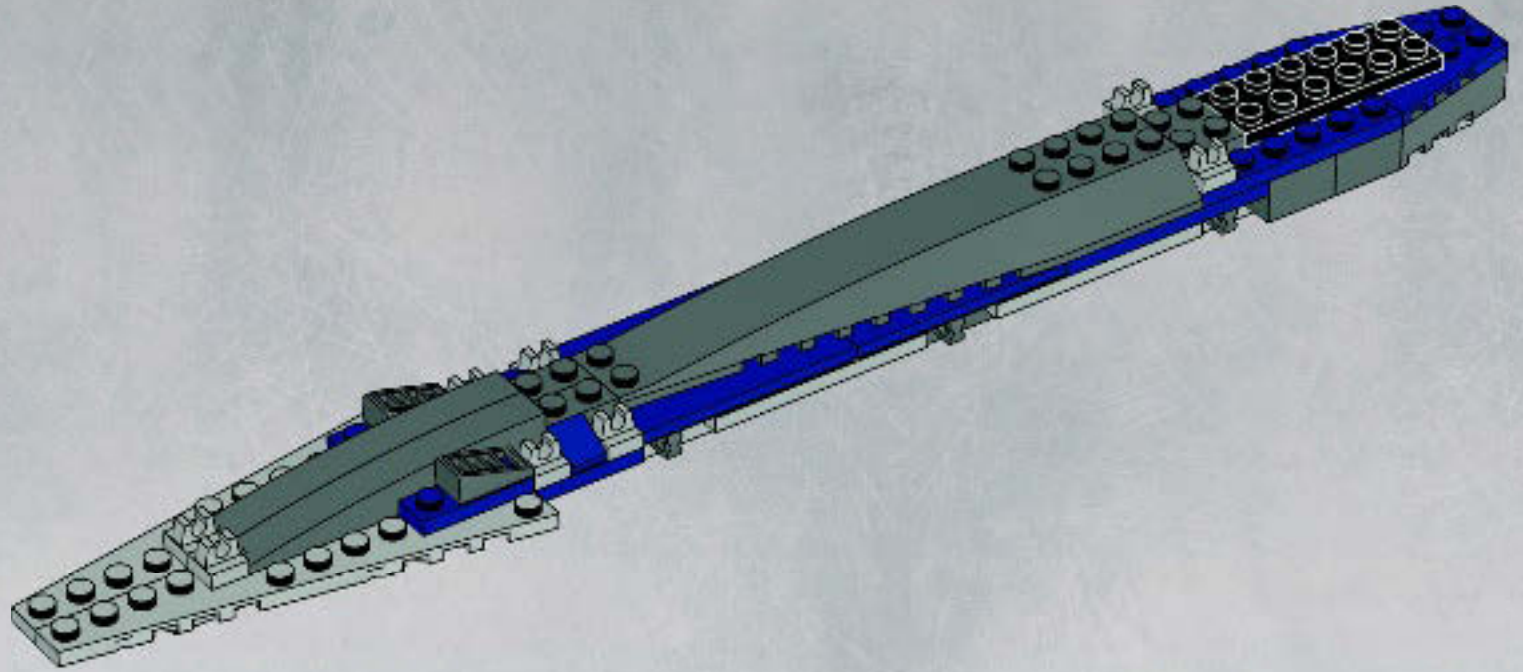

13

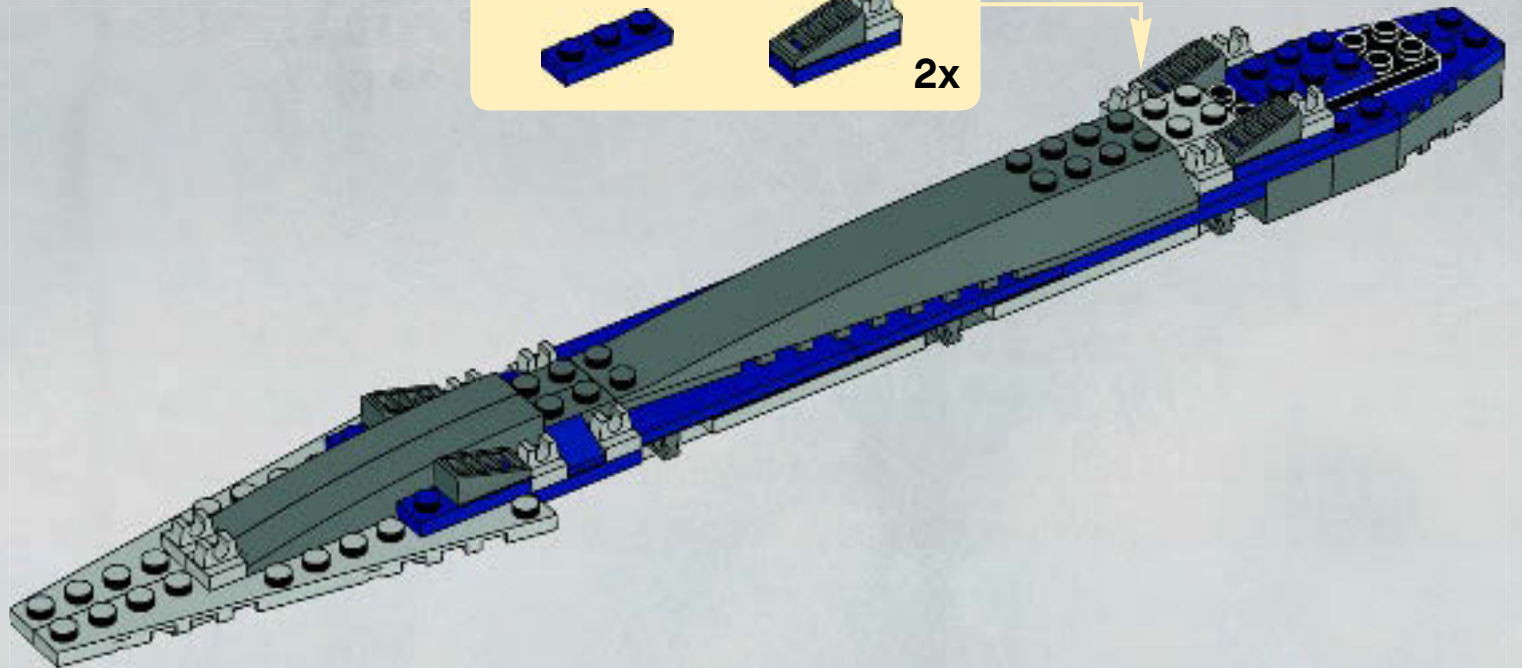
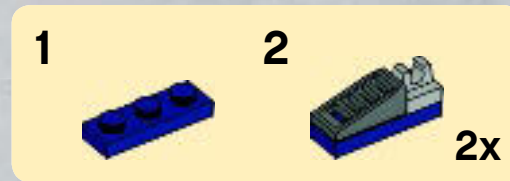



14

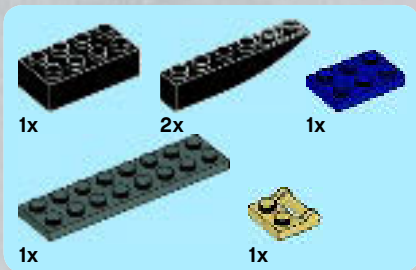
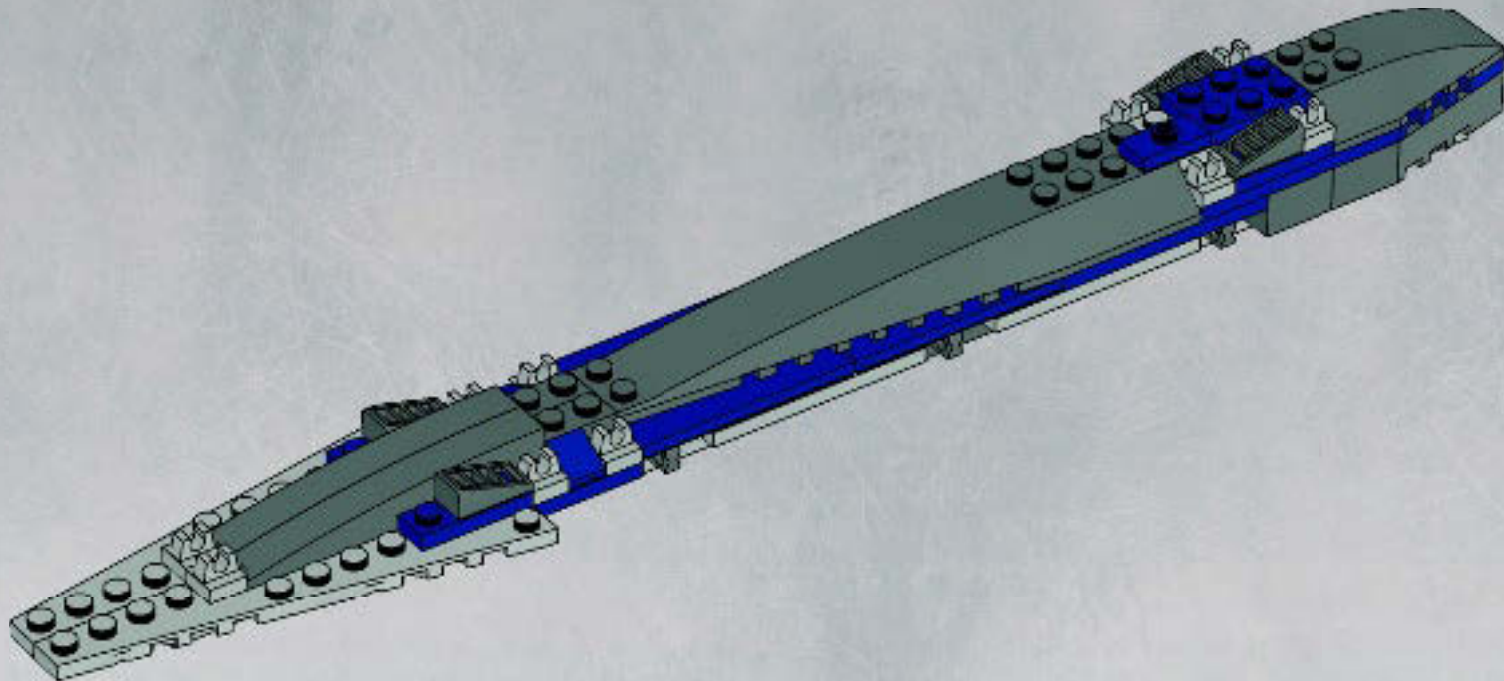

15





16

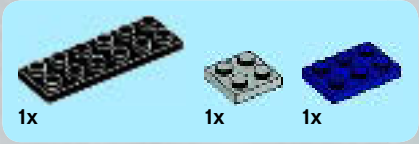
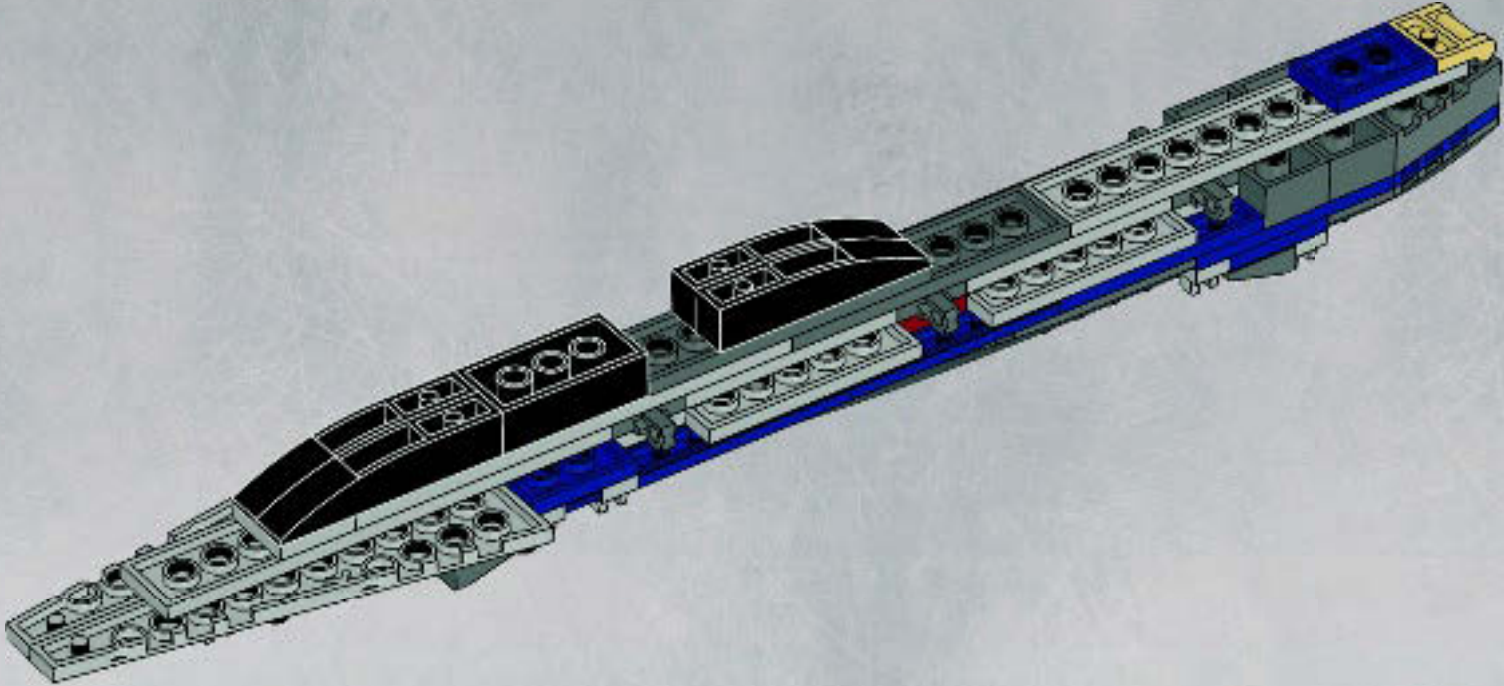

17

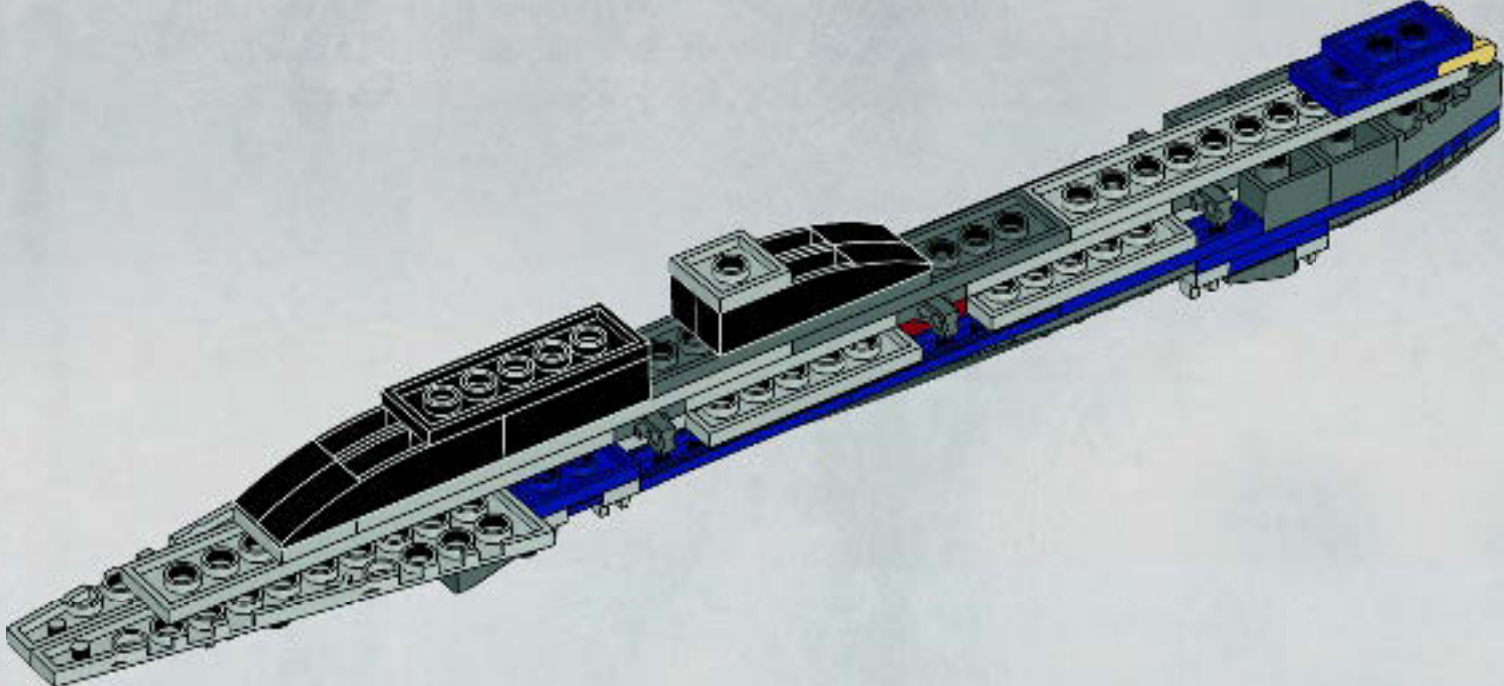



18

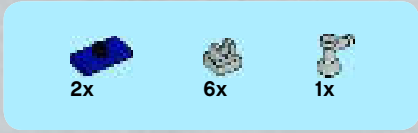
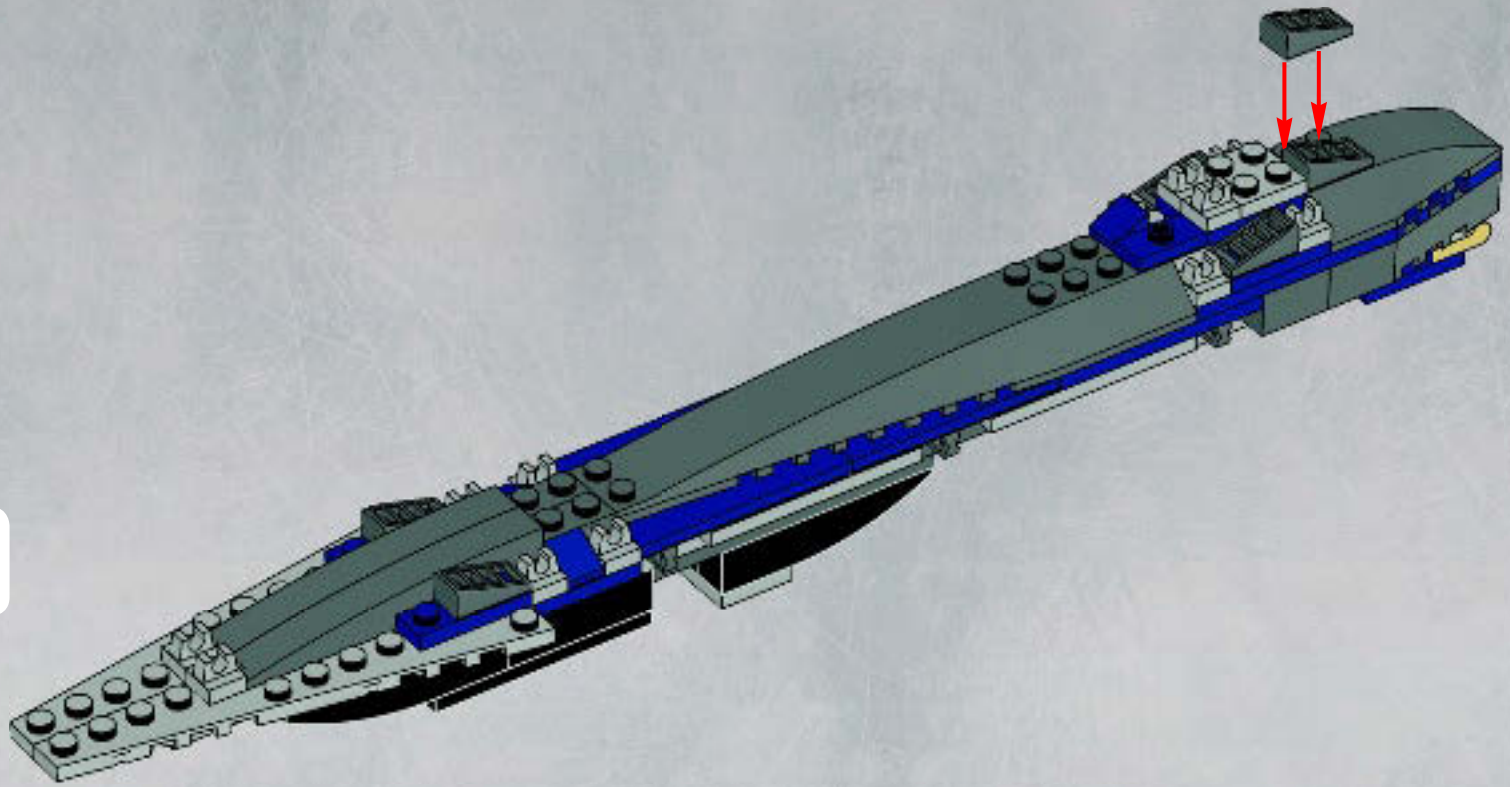

19

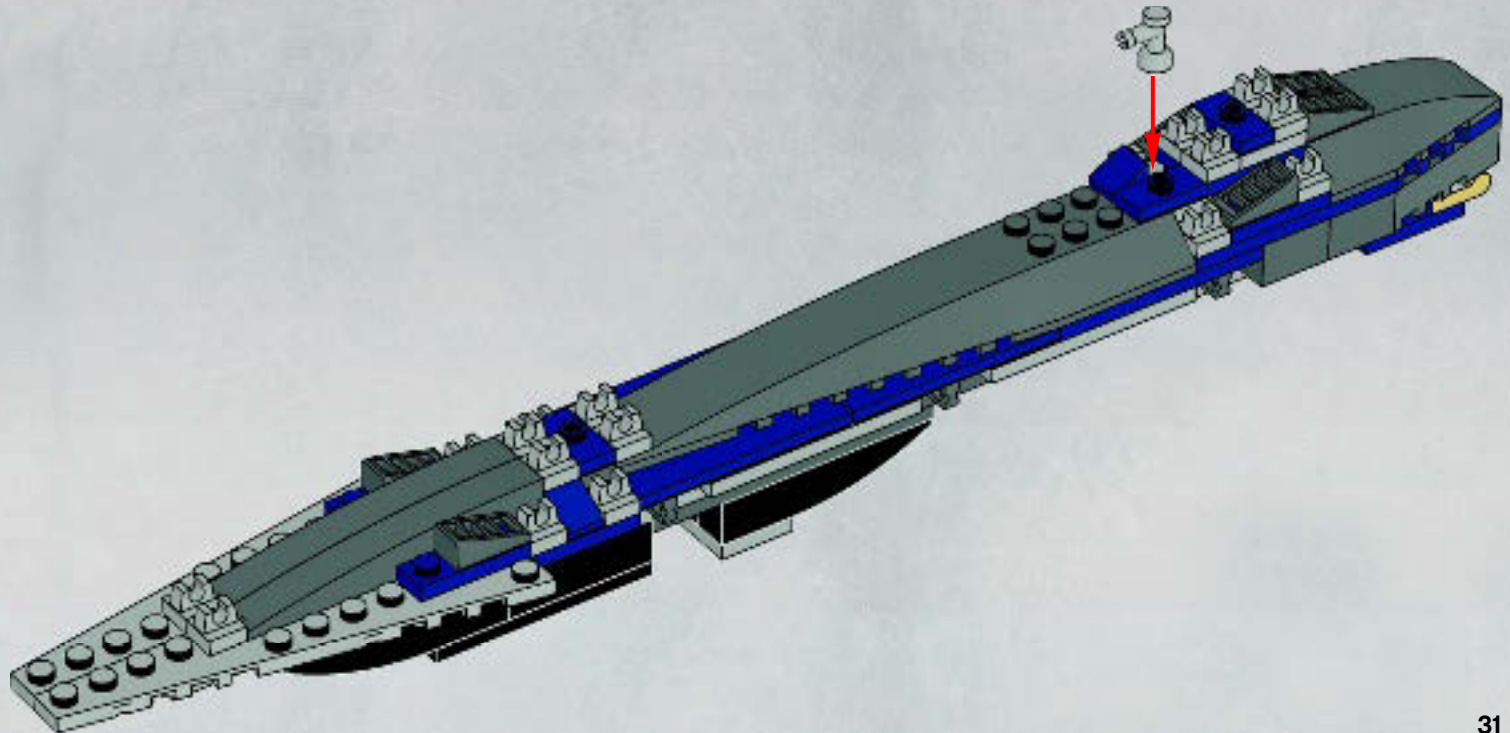

79

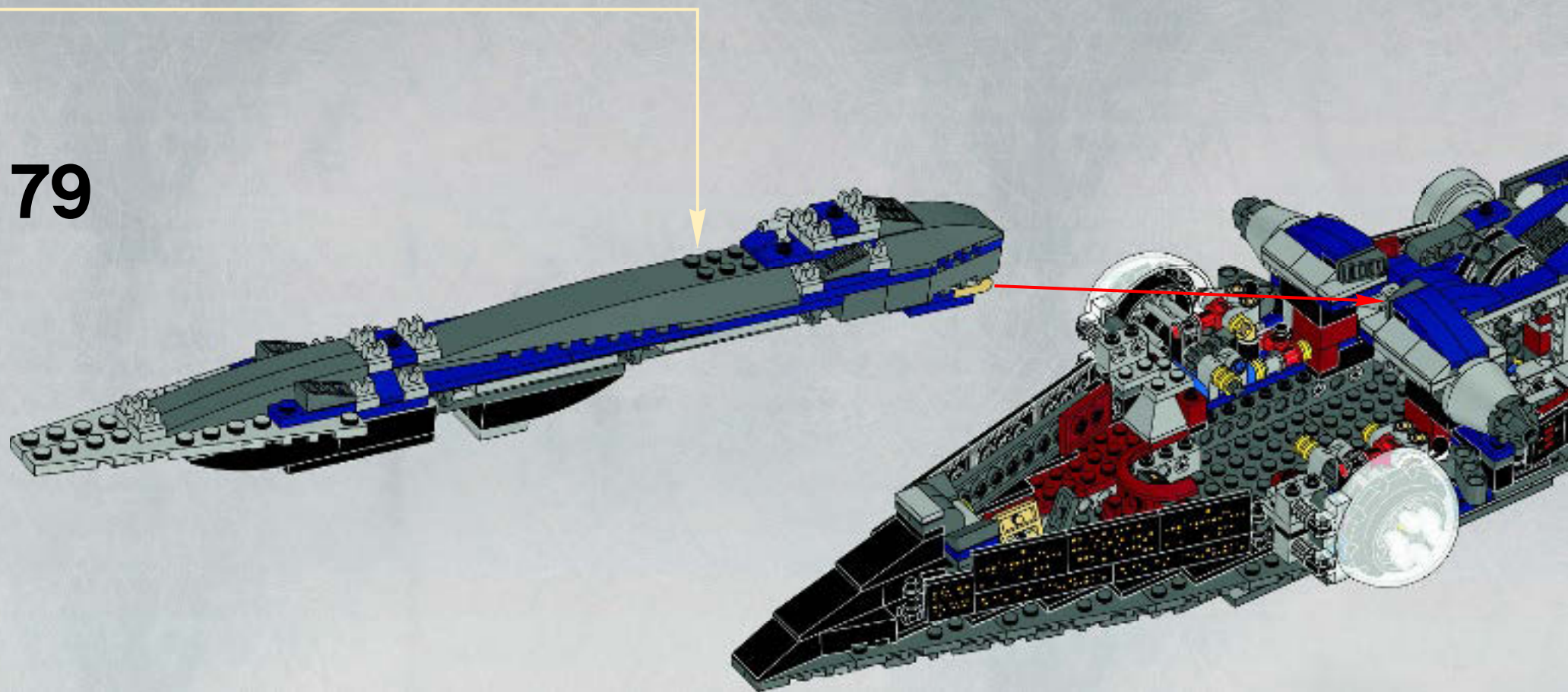



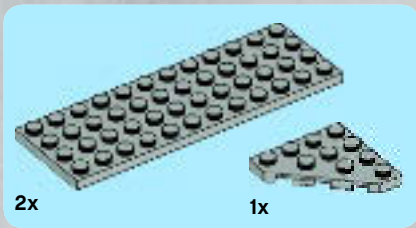

1

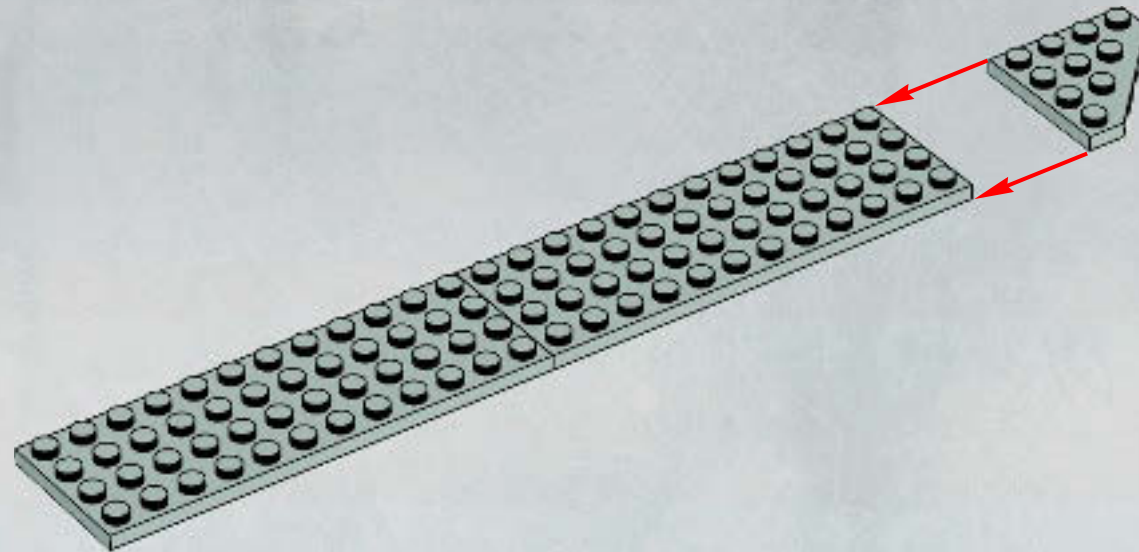

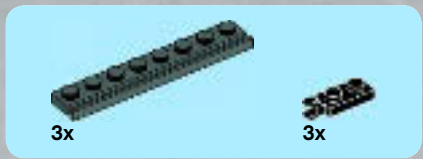

2

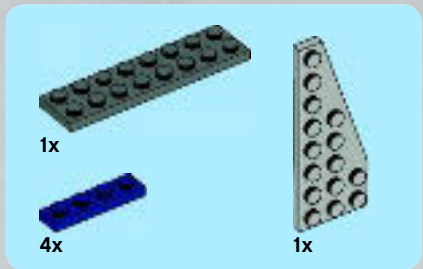
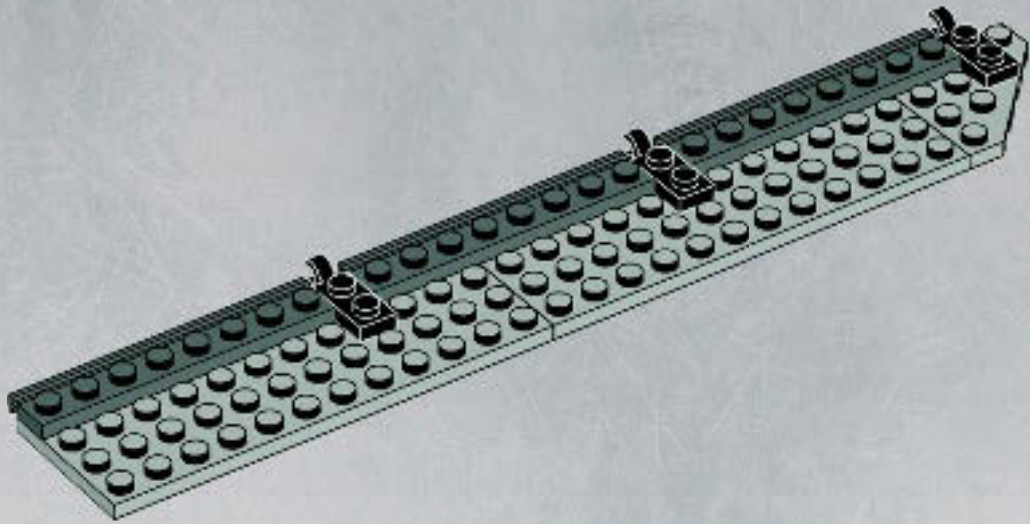

3

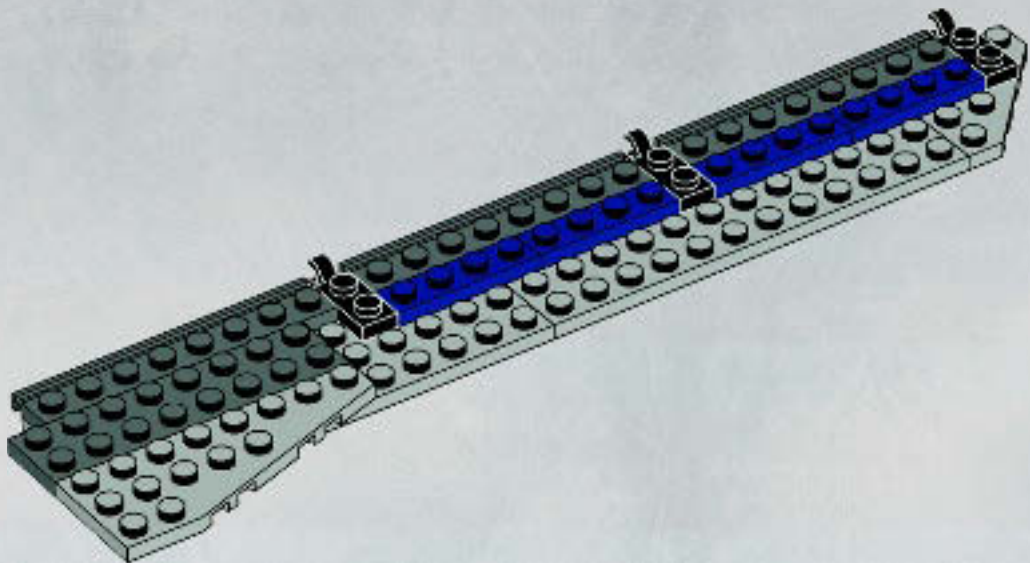

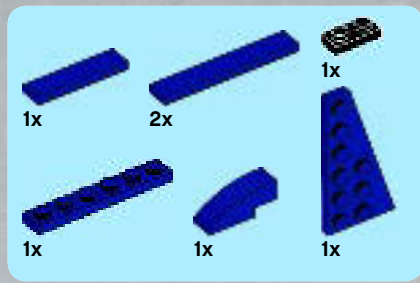

4

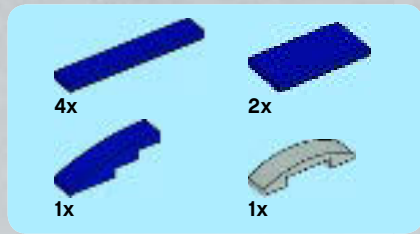
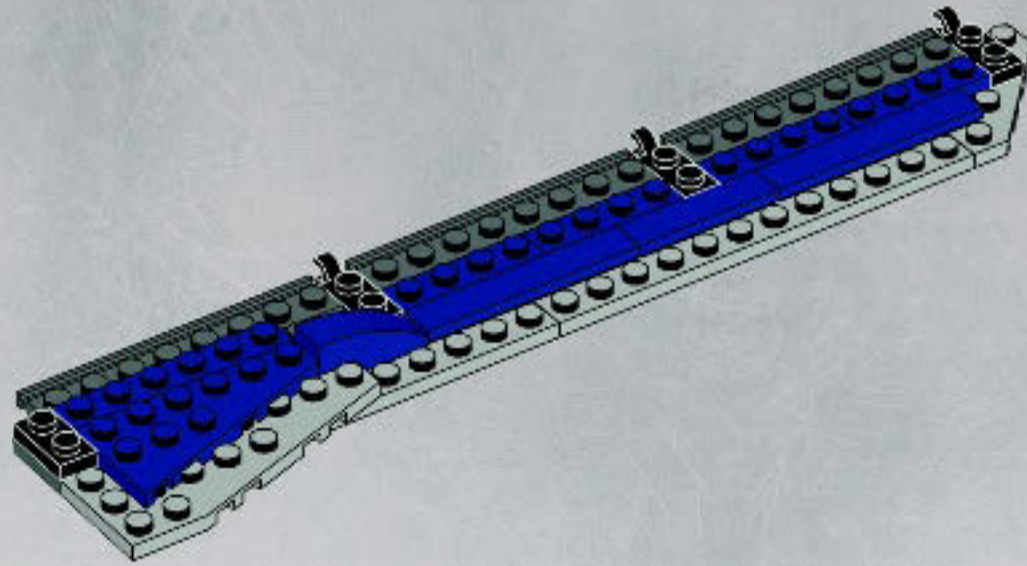

5

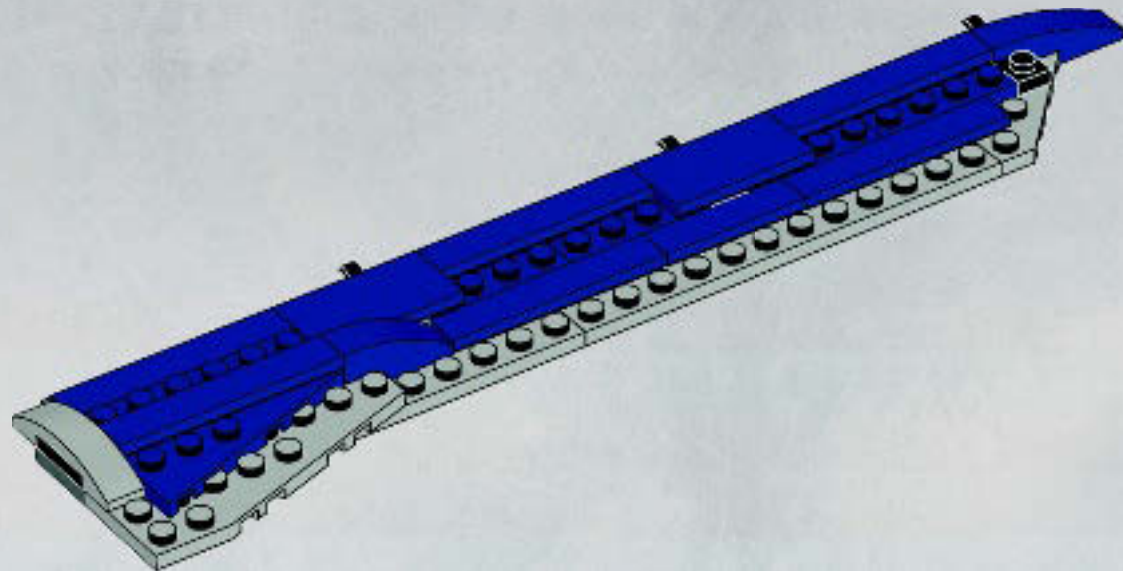



2x

6

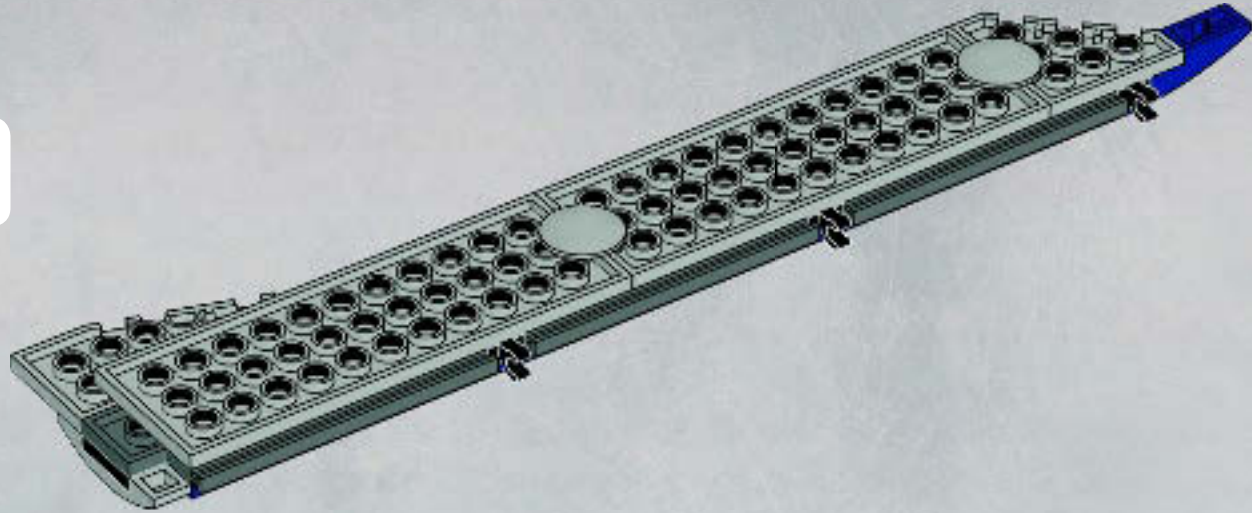

80

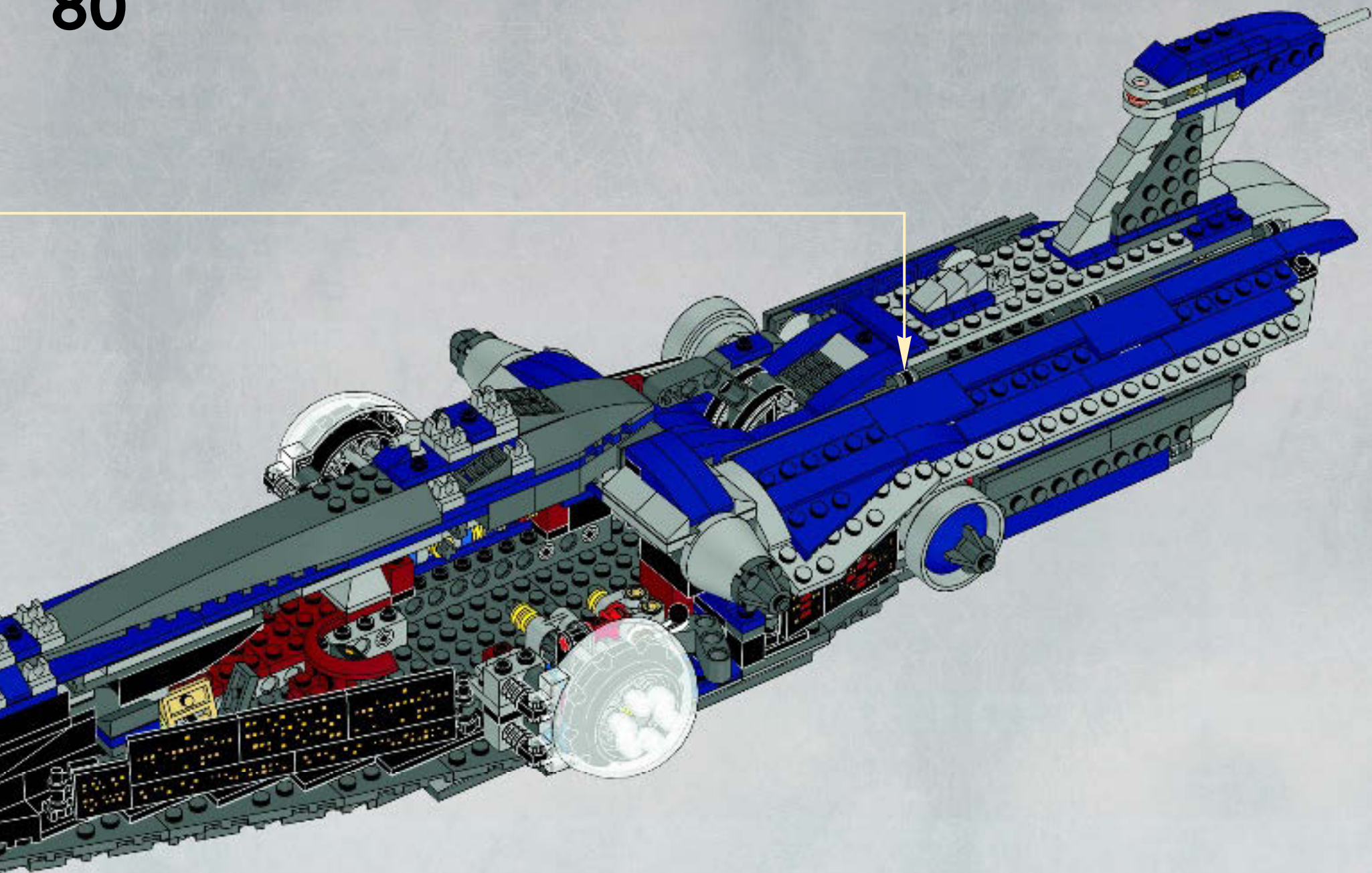

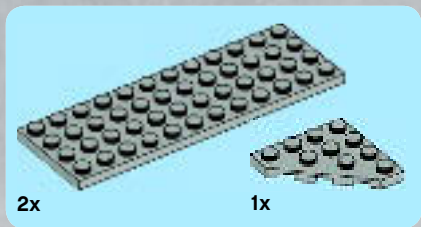

1

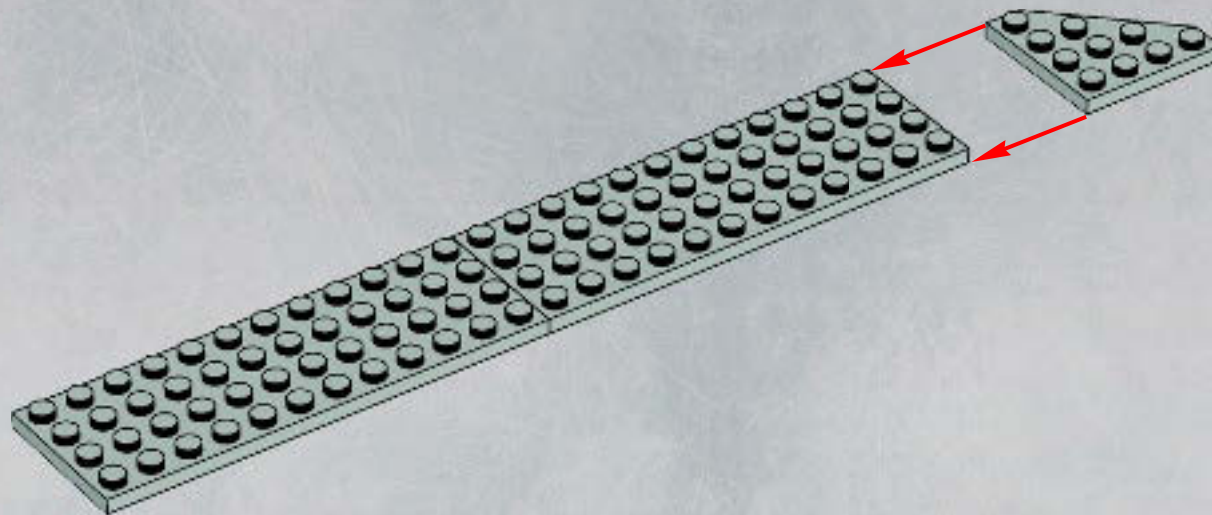

2

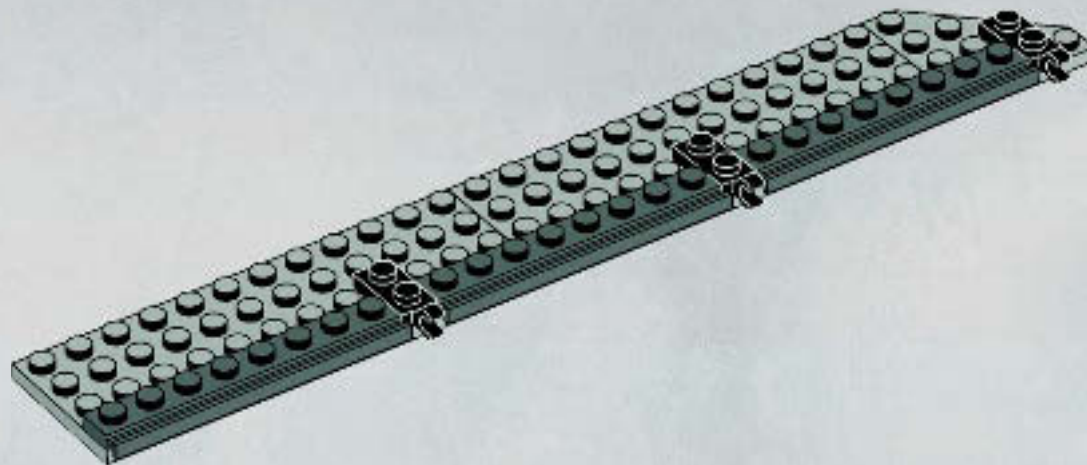

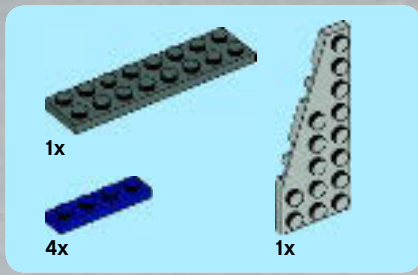

3

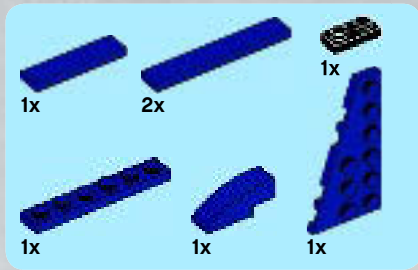
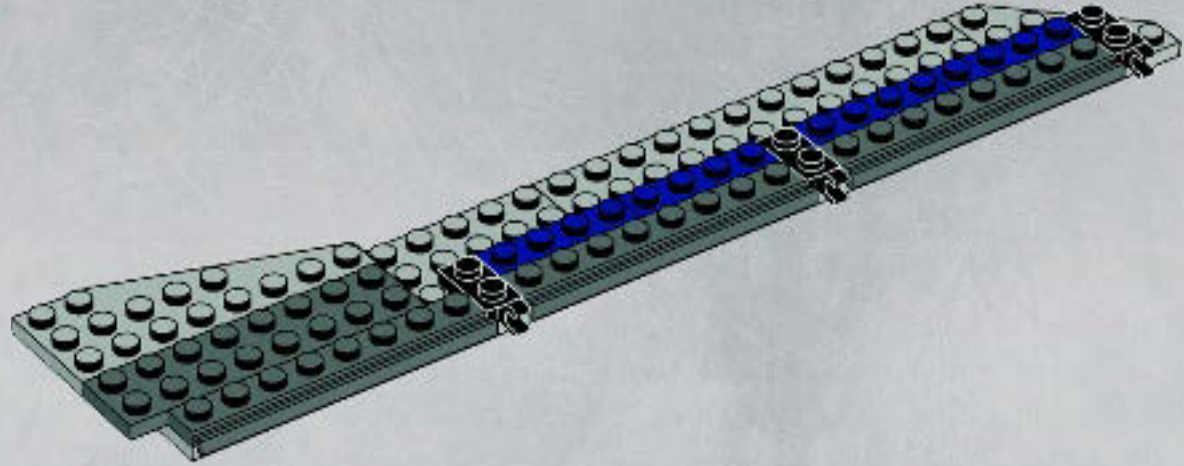

4

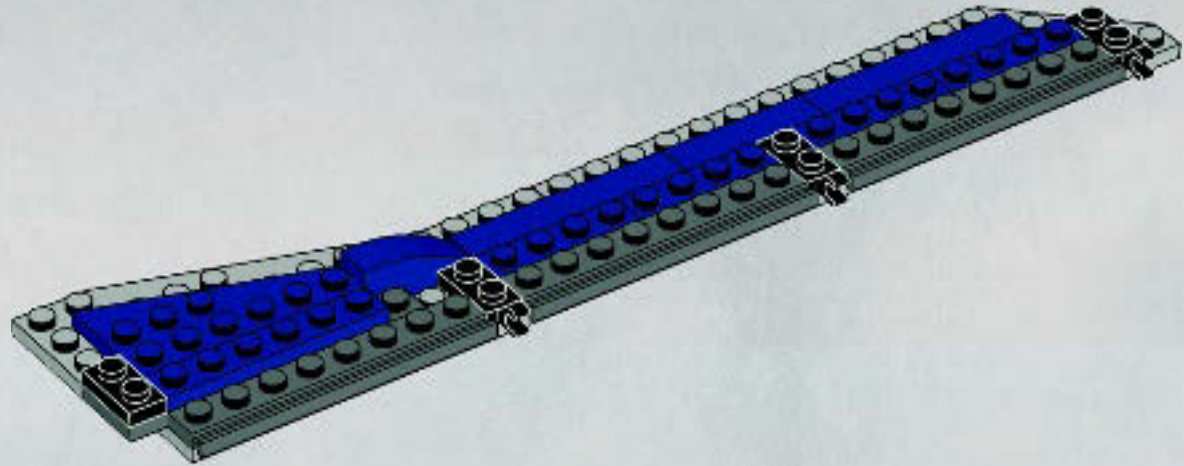

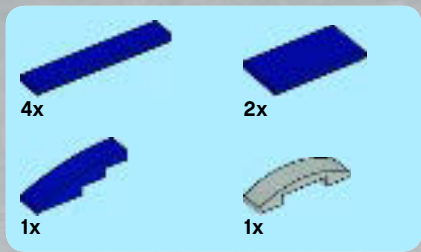

5

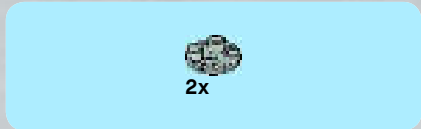
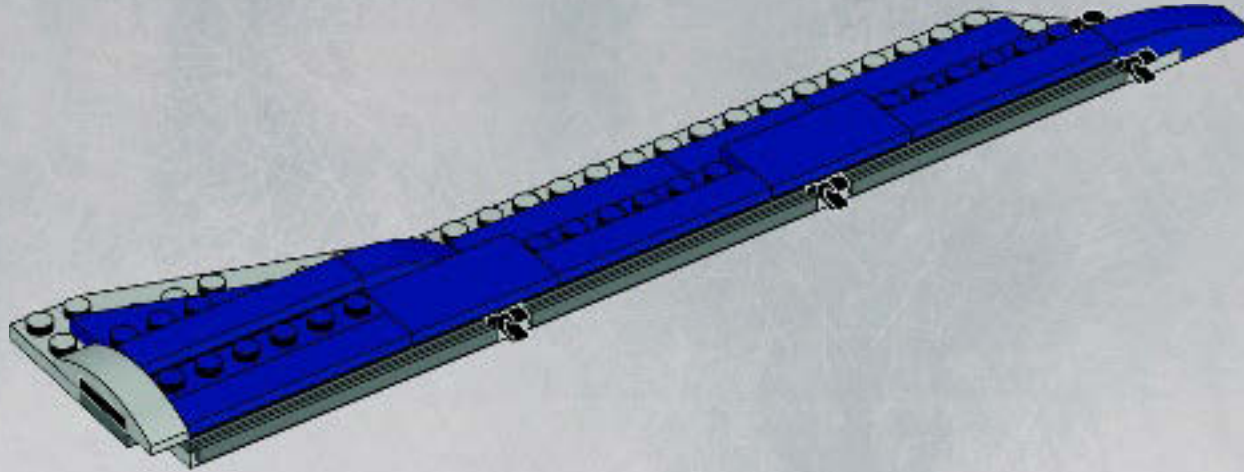

6





81

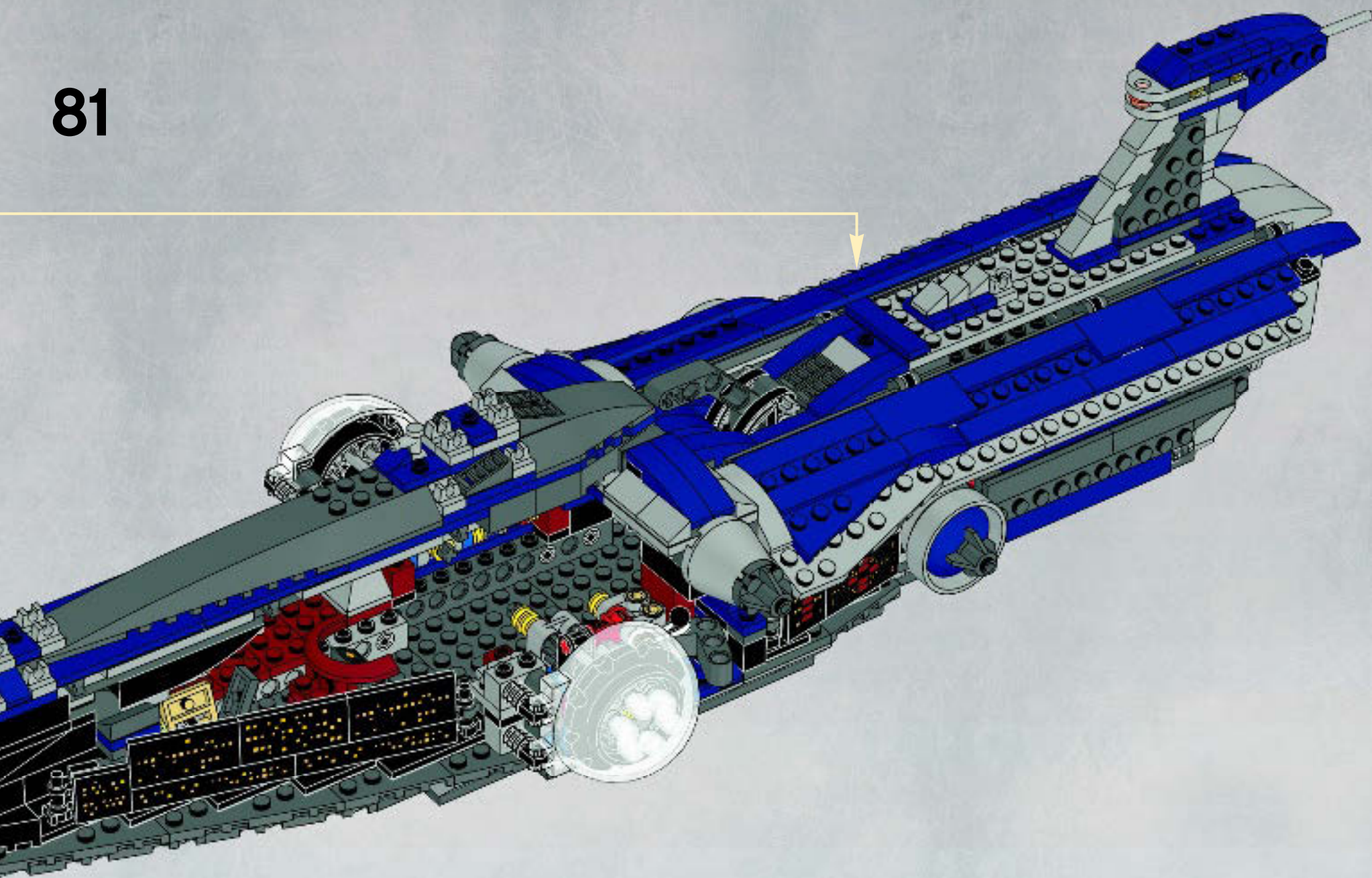

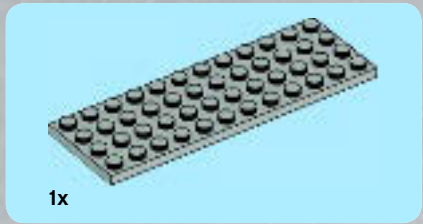
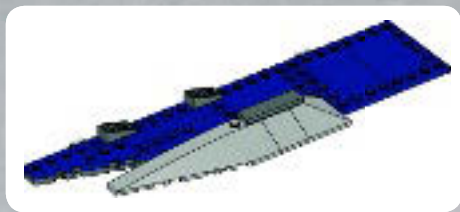

1x

1

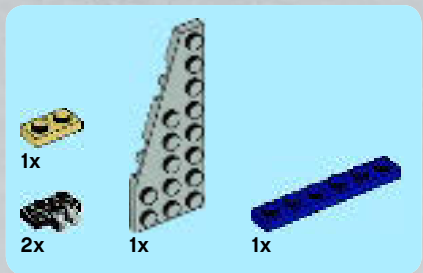

1x

2x

1x

1x

2

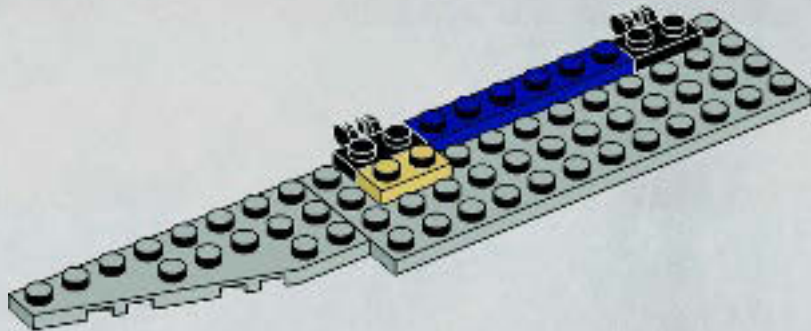



3

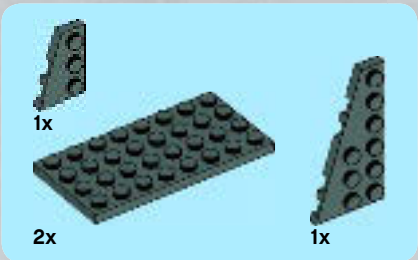
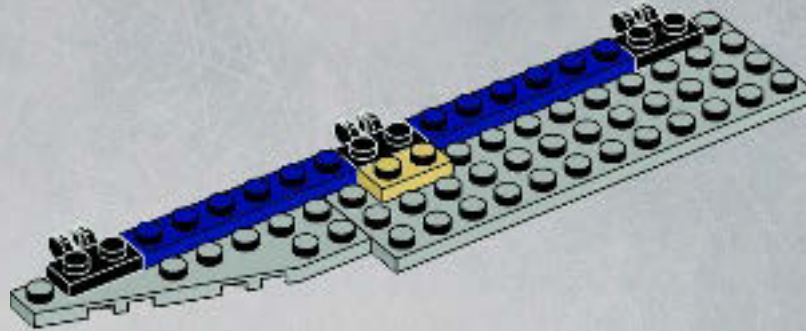

4

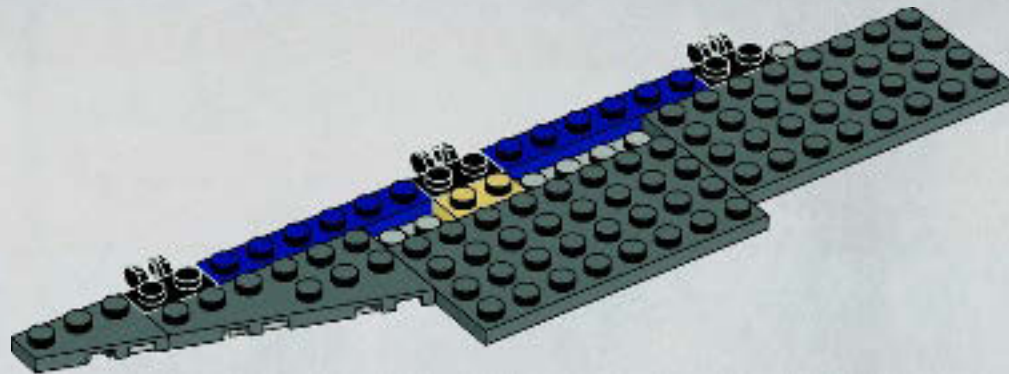

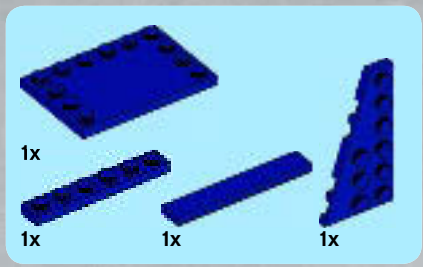

5

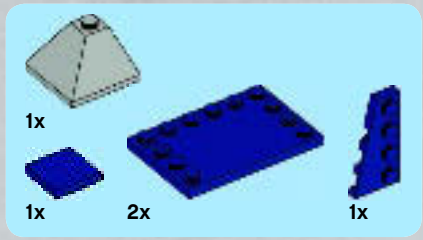
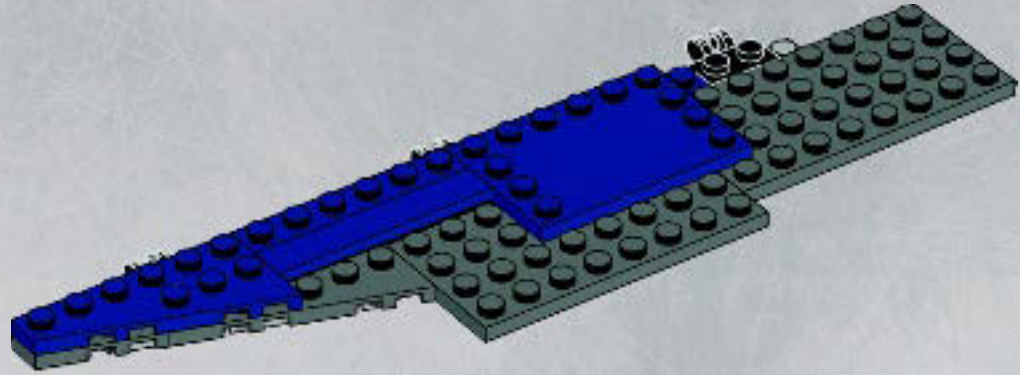

6

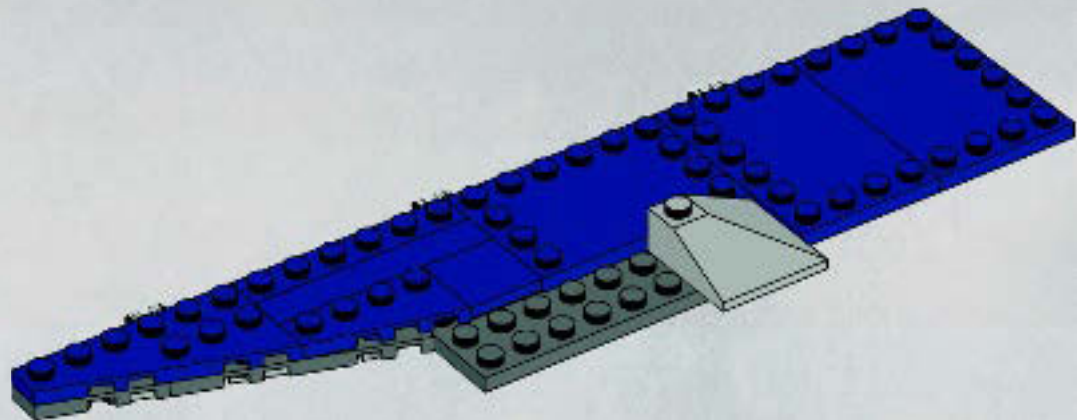

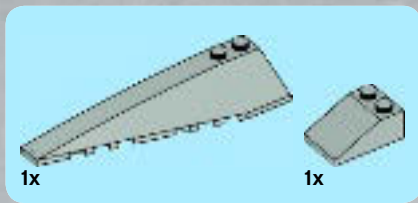

7

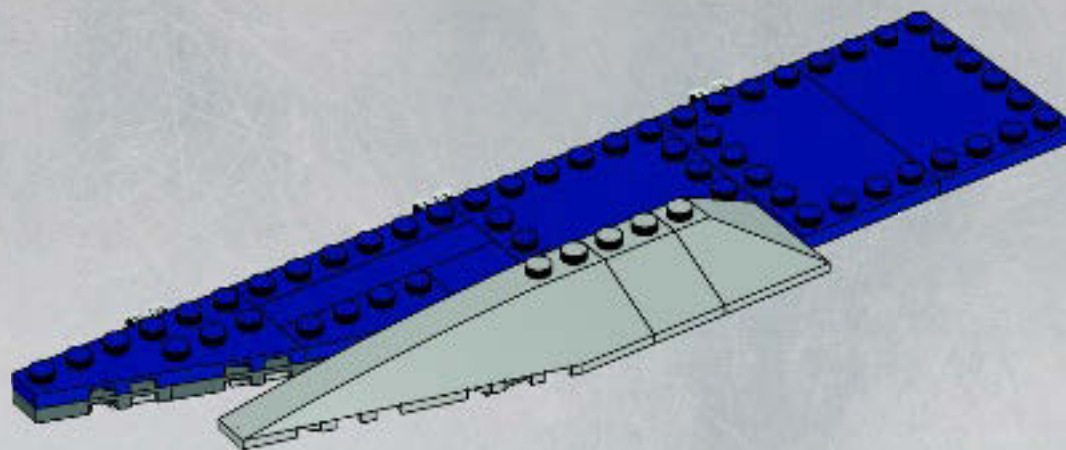

8

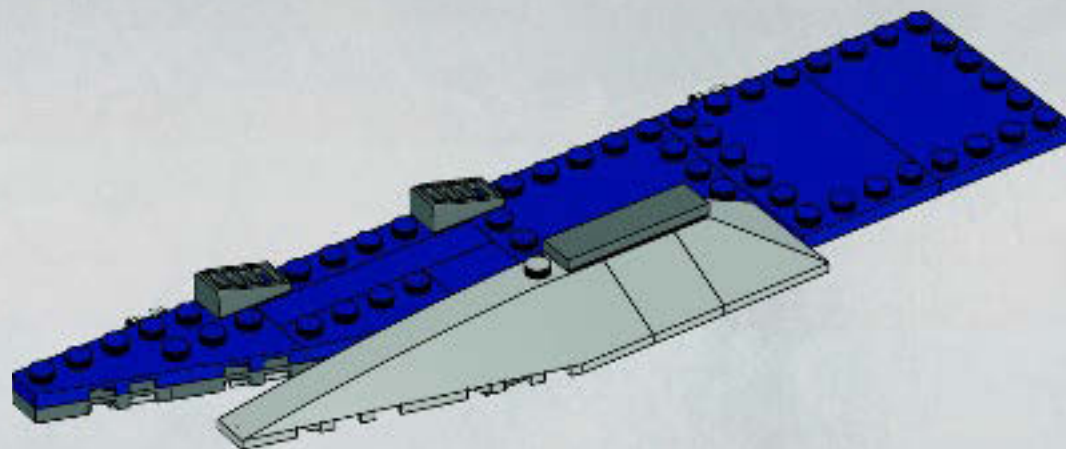

82

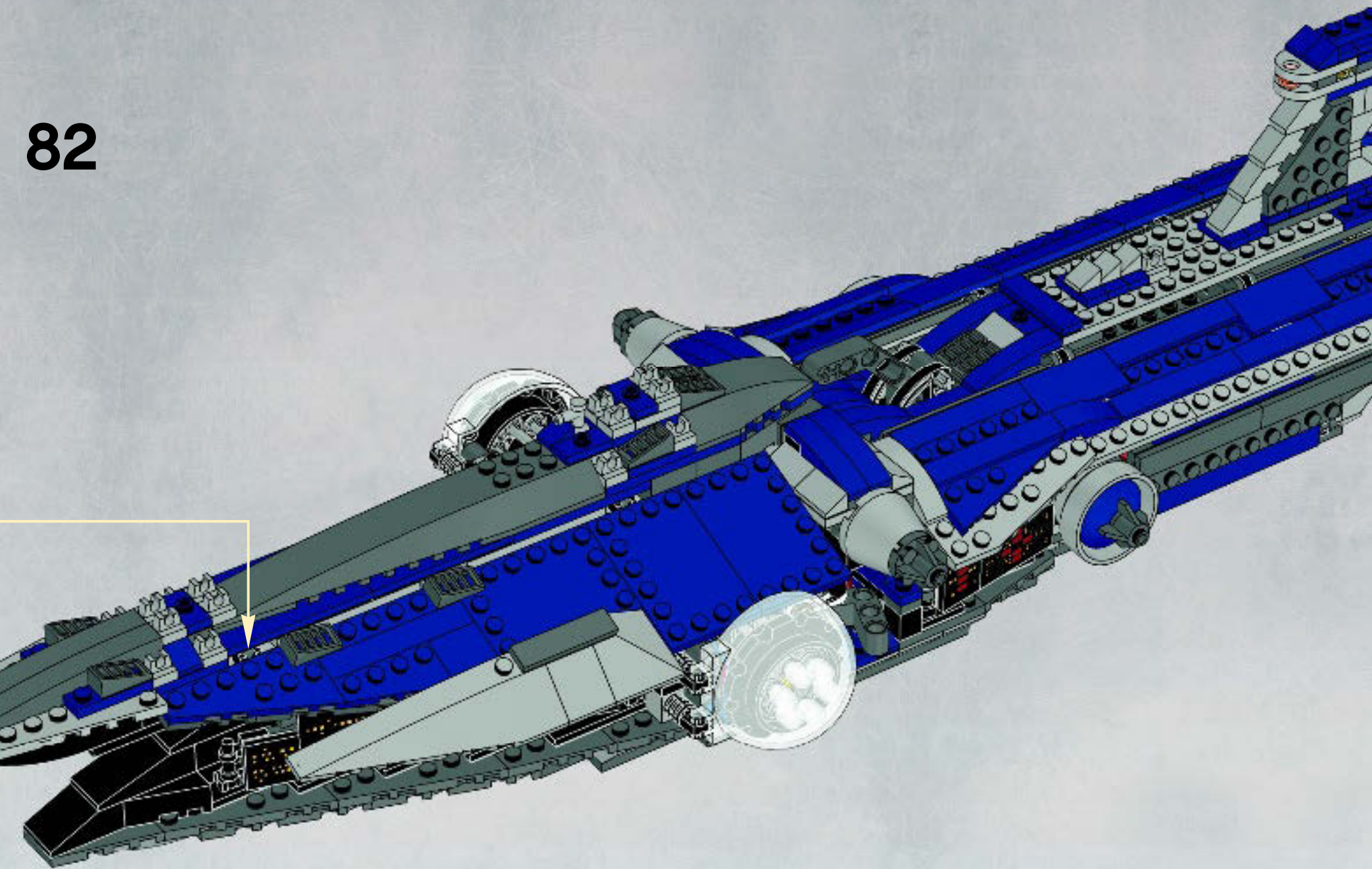

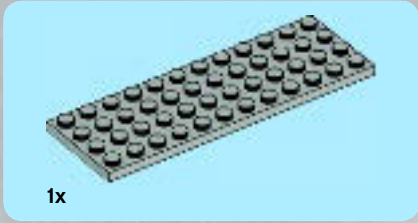

1

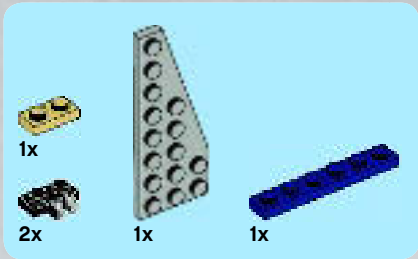
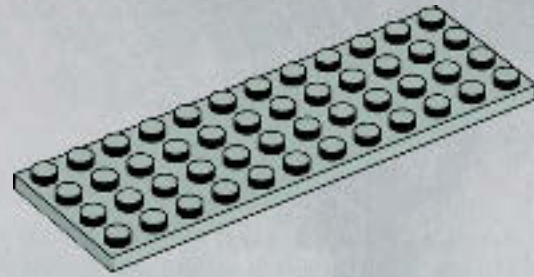

2

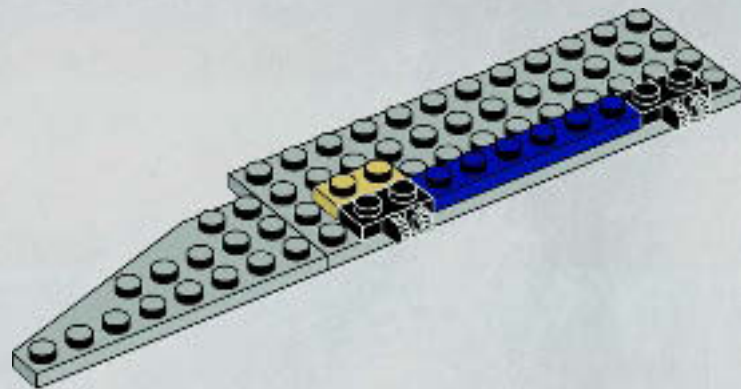



1x



1x

3

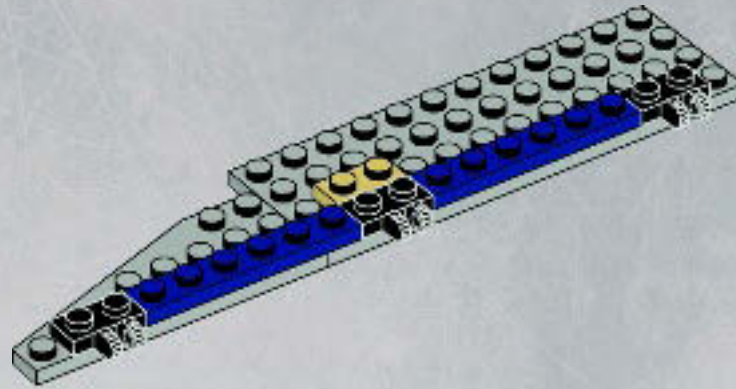

1x



2x



1x

4

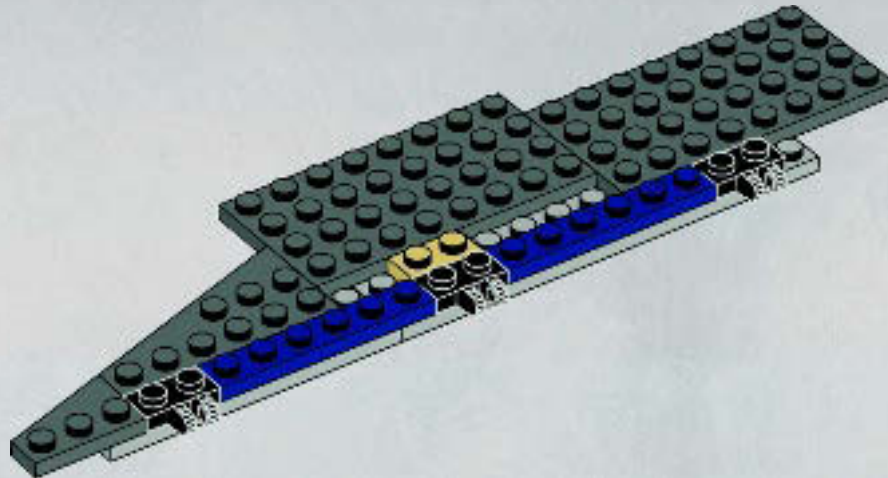



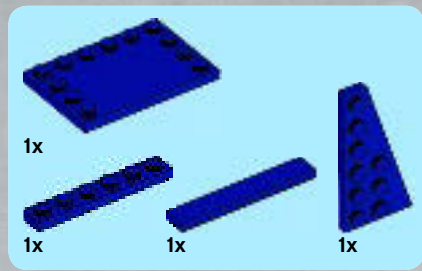

5

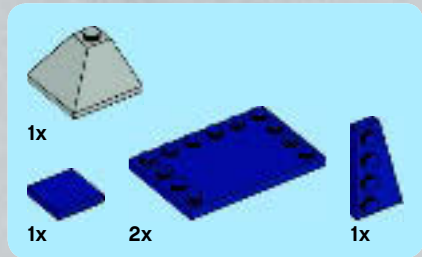
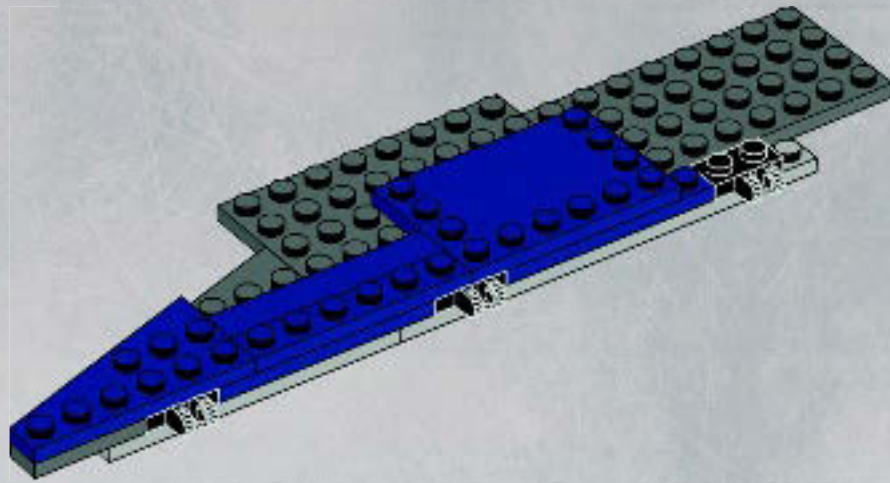

6

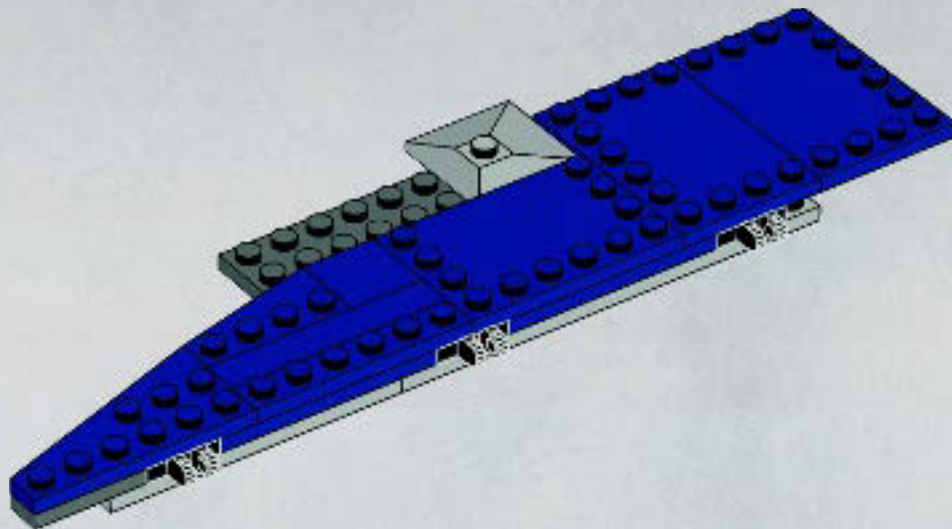

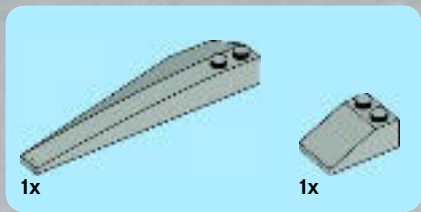

7

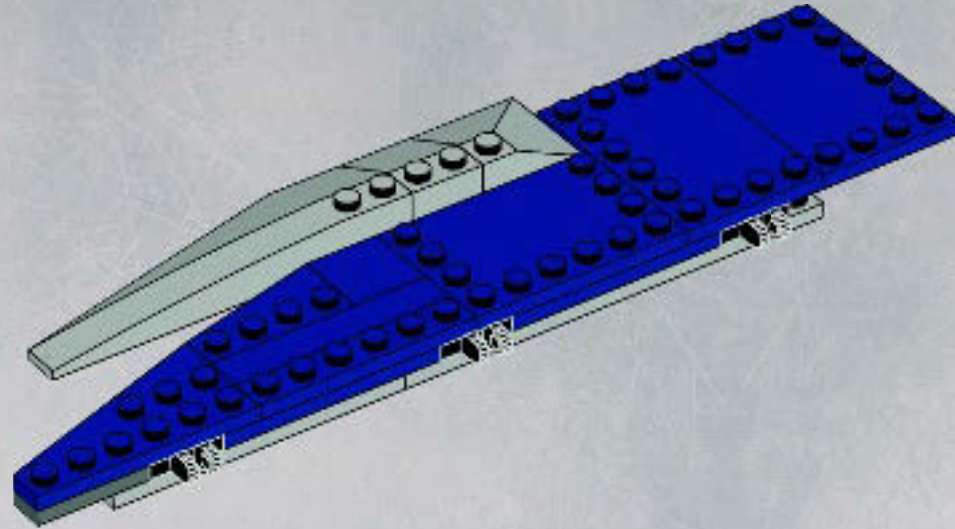

8

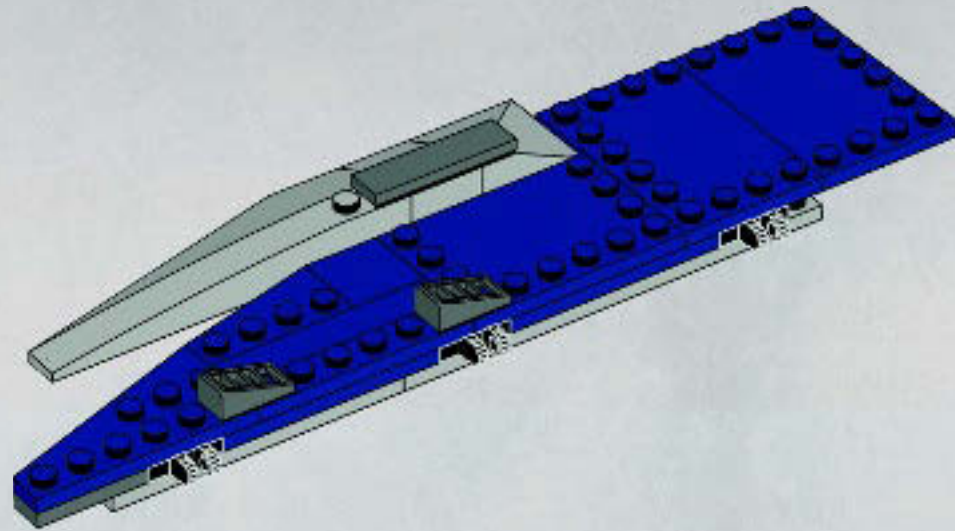

83

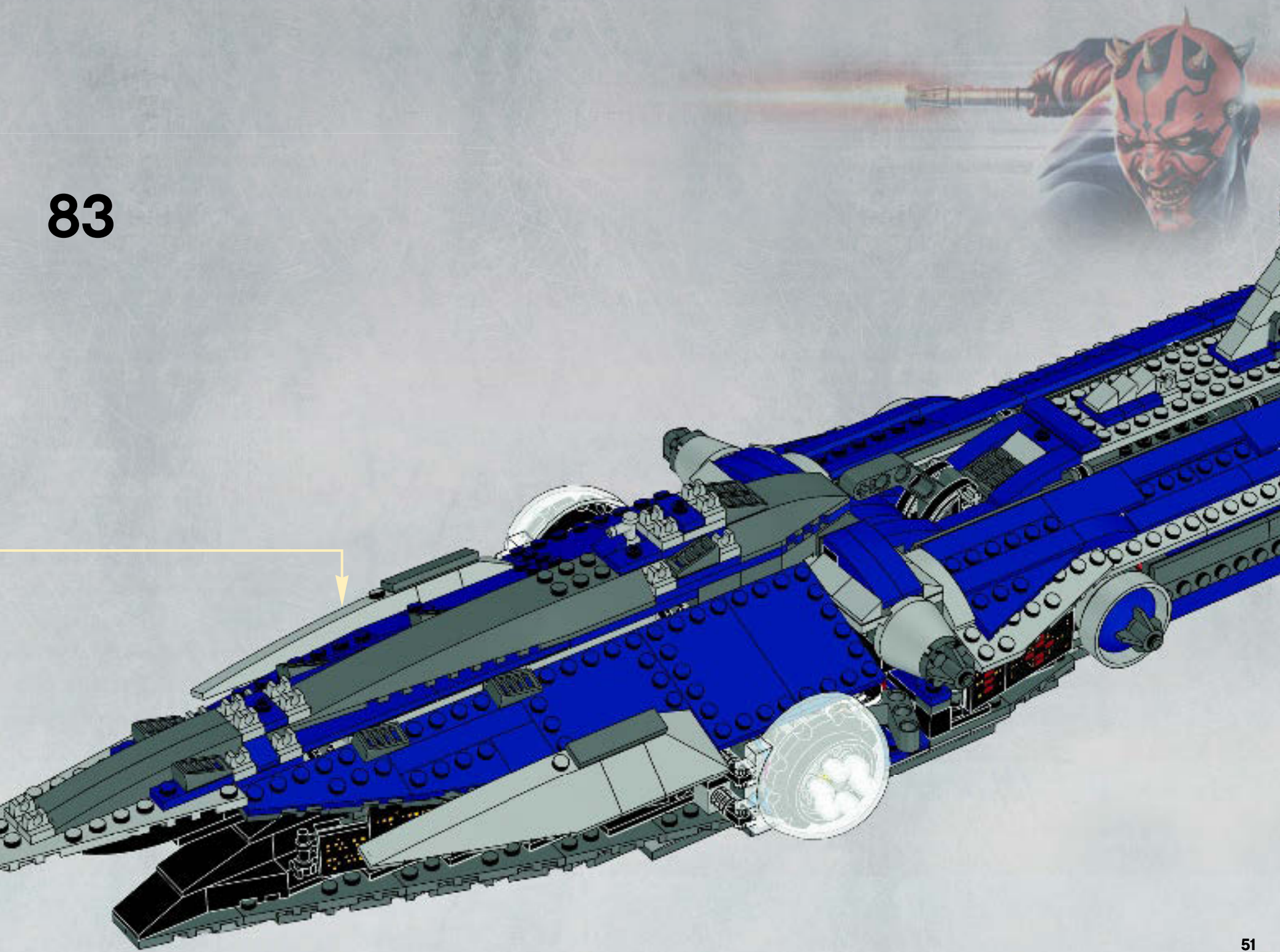

- 2x 4544140
- 1x 4113916
- 1x 4141533
- 1x 4213568
- 2x 4113917
- 3x 4217562
- 4x 4161734
- 2x 4508093
- 1x 4545336
- 2x 4262529
- 1x 4262538
- 2x 6019837
- 2x 4261885
- 1x 6006066
- 1x 6006068
- 4x 4514554
- 4x 4142865
- 4x 4118897
- 4x 4107829
- 14x 4143005
- 6x 4206482
- 13x 4514553
- 16x 4239601
- 4x 300226
- 2x 300126
- 4x 4533771
- 2x 4118624
- 1x 4253815
- 1x 4526931
- 1x 4527766
- 20x 654126
- 8x 370026
- 1x 329826
- 2x 4185583
- 6x 4160409
- 19x 302326
- 8x 371026
- 2x 379526
- 4x 4517925
- 6x 4515340
- 6x 4140588
- 6x 4535739
- 6x 306826
- 1x 4258354
- 12x 243126
- 8x 4560182
- 4x 663626
- 2x 9339
- 1x 4545112
- 1x 4521072
- 1x 452226
- 1x 400626
- 1x 4609050
- 2x 4498713
- 1x 4584126
- 4x 4159335
- 2x 4140430
- 2x 4121667
- 2x 4505842
- 2x 4582792
- 2x 4184169
- 34x 4121715
- 24x 4526982
- 6x 4140801
- 2x 370526
- 3x 370626
- 2x 370726
- 2x 4624369
- 2x 4626400
- 1x 4124108
- 4x 4497943
- 12x 6006124
- 3x 4124073
- 4x 3005744
- 3x 3005747
- 2x 3006349
- 1x 4654448
- 1x 4524098
- 2x 4566927
- 2x 4615996
- 4 2x 370526
- 6 2x 370526
- 8 2x 370526
- 9x 4504374
- 2x 4153653
- 6x 4540280
- 11x 4588293
- 24x 4186627
- 4x 4528482
- 13x 4177735
- 23x 4530028
- 8x 4502089
- 15x 4508313
- 8x 4264890
- 2x 4205004
- 5x 4568393
- 4x 4569836
- 18x 4252437
- 2x 4507080
- 3x 4529954
- 3x 4502091
- 2x 4667979
- 2x 6006628
- 2x 6006630
- 4x 4539102
- 6x 4539104
- 10x 4539092
- 6x 4539059
- 10x 4531415
- 2x 4609925
- 10x 4539082
- 4x 4539063
- 13x 4541510
- 2x 4539062
- 2x 4618986
- 2x 4550169
- 2x 4539083
- 1x 6006045
- 1x 4621617
- 16x 4222960
- 1x 4523794
- 1x 4227505
- 3x 4211389
- 1x 4211502
- 2x 4497653
- 6x 4211541
- 4x 4211374
- 3x 4521921
- 19x 4568637
- 7x 4211614
- 22x 4211437
- 2x 4515374
- 2x 4216250
- 44x 4211436
- 2x 4211421
- 2x 4211570
- 2x 4186667
- 2x 4622803
- 4x 4622742
- 1x 4539887
- 1x 4224592
- 1x 4180464
- 1x 4505088
- 1x 4505087
- 5x 4211398
- 23x 4211397
- 3x 4243797
- 2x 4211452
- 4x 4211425
- 2x 4211404
- 1x 4514846
- 3x 4211360
- 6x 4211401

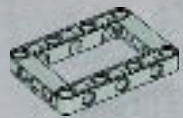

2x  
4539880

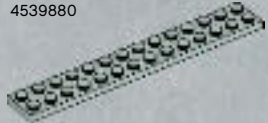

2x  
4662161

19x  
4211369

3x  
4211414

10x  
4211413

2x  
4558169

2x  
4211419

1x  
4667166

12x  
4278273



1x  
4208988



2x  
4258273

4x  
4211889



2x  
4258275



1x  
4209006



2x  
4160560



2x  
4211536



1x  
4211503



1x  
4211628



2x  
4211473



2x  
4511007



12x  
4520320



5x  
4211651



2x  
6004888



2x  
4211622



8x  
4211758



1x  
4211815



2x  
4211639



1x  
4626931



2x  
6000606



4x  
4211109



3x  
4211085



4x  
4210935



1x  
4287972



1x  
4287973



6x  
4211137



4x  
4567887



14x  
4540386



4x  
4212352

3

5



2x  
4658974



8x  
4210797



2x  
4579241



1x  
4180486



1x  
4260406



2x  
4211063



14x  
4211065



5x  
4210997



6x  
4210997



5x  
4257526



6x  
4211061



3x  
4210678



2x  
4210753



4x  
4211122



2x  
4211067



2x  
4210706



2x  
4210720

4x  
4587212

6x  
4210892

11x  
4521187

2x  
4211053

4x  
4210651

6x  
4210967

2x  
4210872

2x  
4210869

2x  
4210869

2x  
4210869

2x  
4210869

2x  
4210869

2x  
4210869

2x  
4210869

2x  
4210869

2x  
4210869



5x  
4210782



2x  
4211042



5x  
4290149



2x  
4210728



1x  
4520307

2x  
6019839

2x  
6019836

1x  
6019834

1x  
6019833

1x  
6019833

1x  
6019833

5x  
4548731

1x  
6019833

1x  
6019833

1x  
6019833

1x  
6019833

1x  
6019833

1x  
6019833

1x  
6019833

1x  
6019833

1x  
6019833

1x  
6019833



2x  
4210751



1x  
4495931



1x  
4210668



1x  
4210749



2x  
4560177



2x  
4499858



4x  
4514559



1x  
4521066



1x  
4541613



1x  
6005953



1x  
4541966



5x  
4548731



5x  
4548731

5x  
4548731

5x  
4548731

5x  
4548731

**Customer Service**  
Kundenservice  
Service Consommateurs  
Servicio Al Consumidor

[www.lego.com/service](http://www.lego.com/service) or dial



: 00800 5346 5555

: 1-800-422-5346

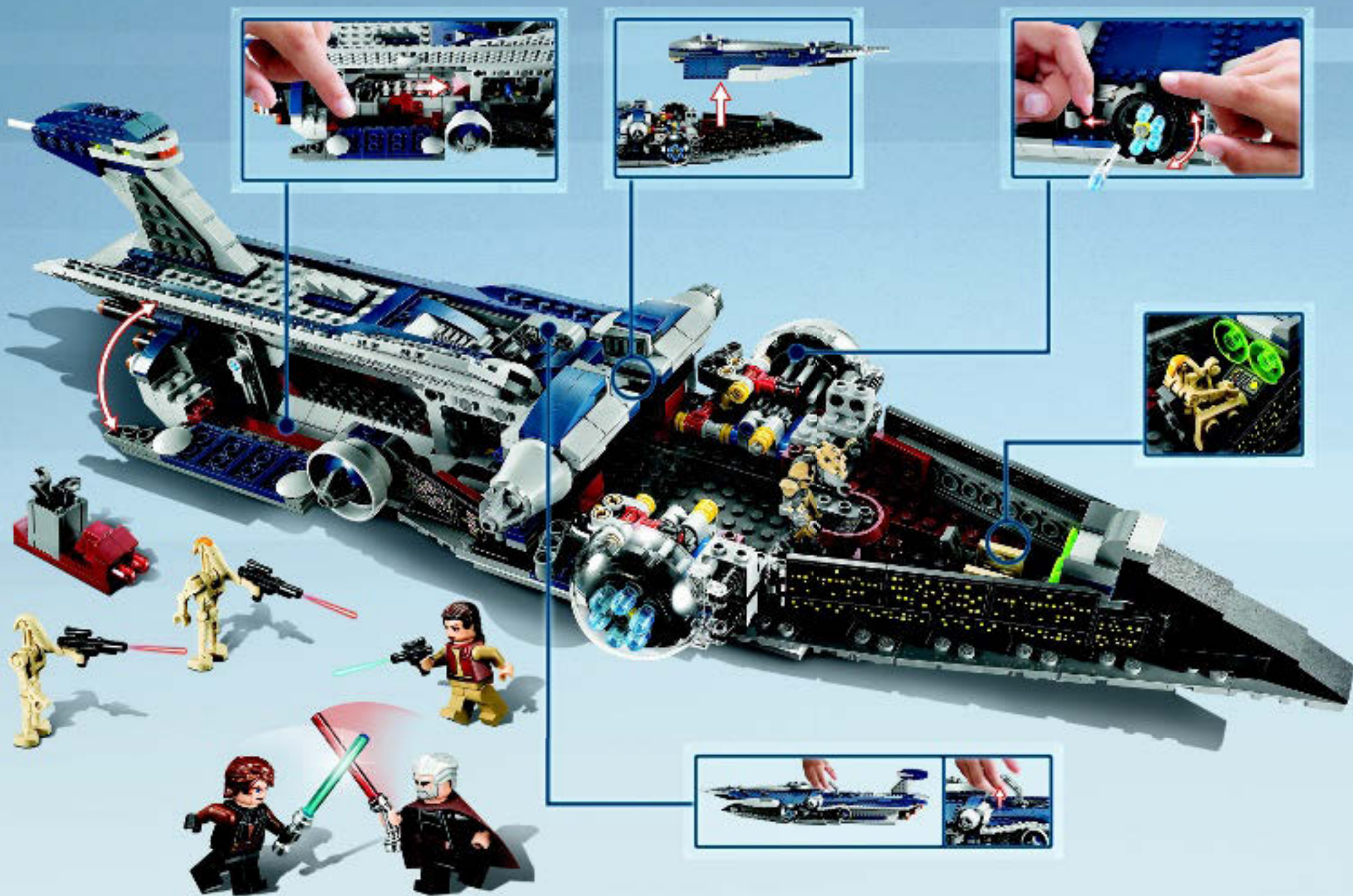





9496



9498



9497



9499



9500



9515



9516





9496



9496



9496



9496



9497



9497



9497



9498



9498



9498



9499



9499



9499



9499



9500



9500



9500



9515



9515



9515



9515



9515



9515



9516



9516



9516



9516



9516



9516



9516



9516



9516



9516

1



2



3

[www.LEGOclub.com/Max](http://www.LEGOclub.com/Max)

[www.LEGOclub.com/Max](http://www.LEGOclub.com/Max)



**club**™

**FREE\*! GRATIS! GRATUIT!**

\*Paid subscription in Australia and New Zealand.  
\*Abonnement payant en Australie et Nouvelle-Zélande.



**ATELIER DE BD**



 [starwars.LEGO.com](http://starwars.LEGO.com)



# WIN!

Go to [www.LEGOsurvey.com/product](http://www.LEGOsurvey.com/product) to fill out a survey for a chance to win a cool LEGO® Product. No purchase necessary. Open to all residents where not prohibited.



[www.LEGO.com](http://www.LEGO.com)



## [www.LEGOsurvey.com/product](http://www.LEGOsurvey.com/product)

### GEWINNE!

Nimm an der Umfrage auf [www.LEGOsurvey.com/product](http://www.LEGOsurvey.com/product) teil und hab die Chance ein cooles LEGO® Produkt zu gewinnen! Die Teilnahme am Gewinnspiel führt zu keinerlei Kaufverpflichtungen. Teilnahme in allen nicht ausgeschlossenen Ländern möglich.

### WIN!

Ga naar [www.LEGOsurvey.com/product](http://www.LEGOsurvey.com/product), vul een enquêteformulier in en maak kans op een cool LEGO® product. Geen aankoopverplichting. Iedereen mag deelnemen, uitgezonderd ingezetenden van landen waar een enquêteverbod geldt.

### GAGNE!

Visite [www.LEGOsurvey.com/product](http://www.LEGOsurvey.com/product) pour répondre à un questionnaire et avoir une chance de gagner un produit LEGO® très cool ! Aucune obligation d'achat. Ouvert à tous les résidents des pays autorisés.

### 当てよう!

[www.LEGOsurvey.com/product](http://www.LEGOsurvey.com/product) にアクセスして、アンケートにご記入ください。当選者にはレゴ製品を差し上げます。お買い上げの必要はありません。禁止されていない限り、すべての皆様にご利用いただけます。