



# STAR WARS



9516



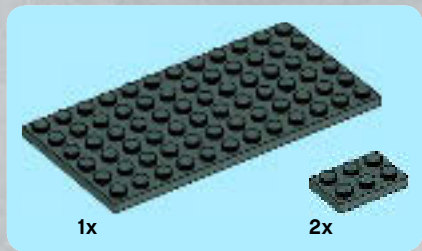
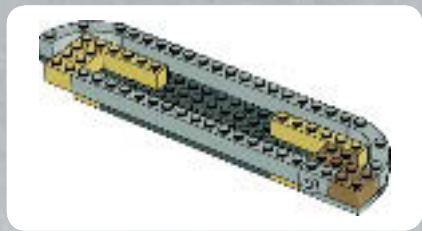
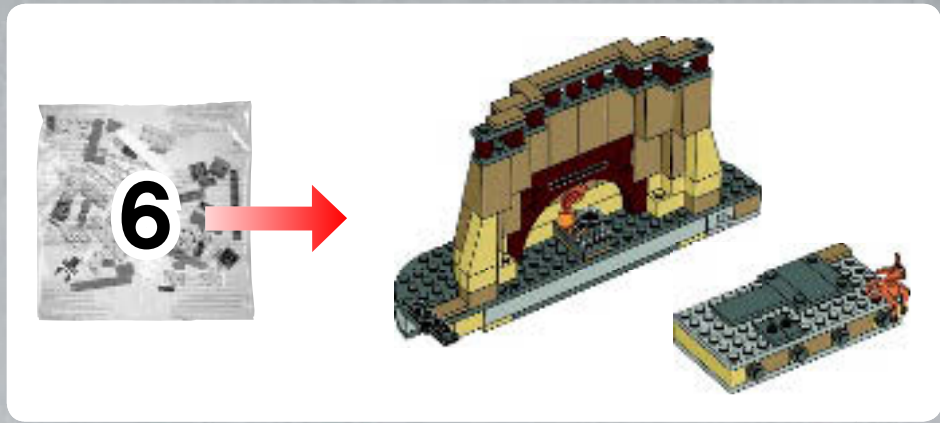

1

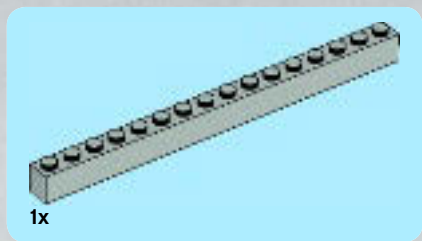
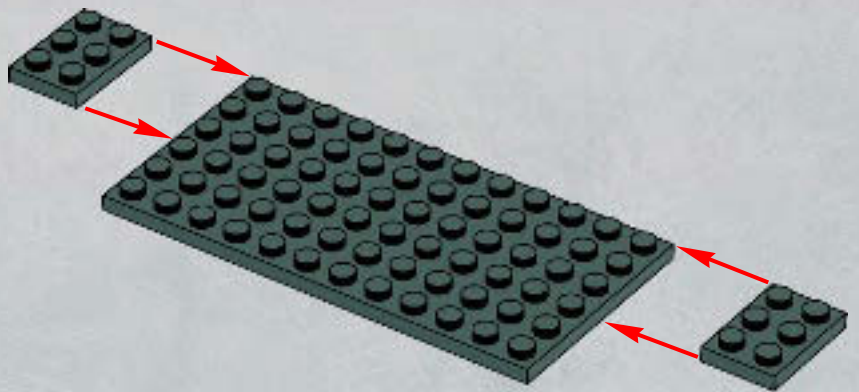

2

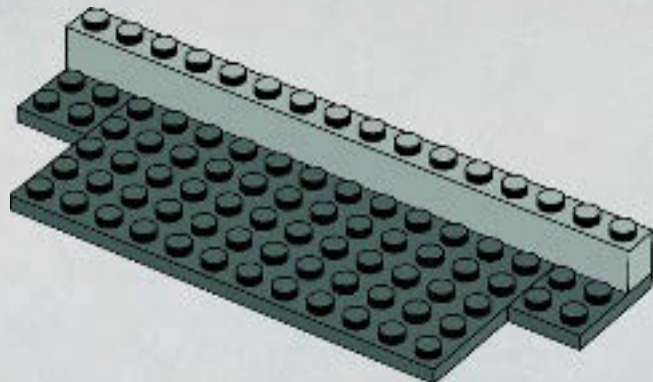



2x

3

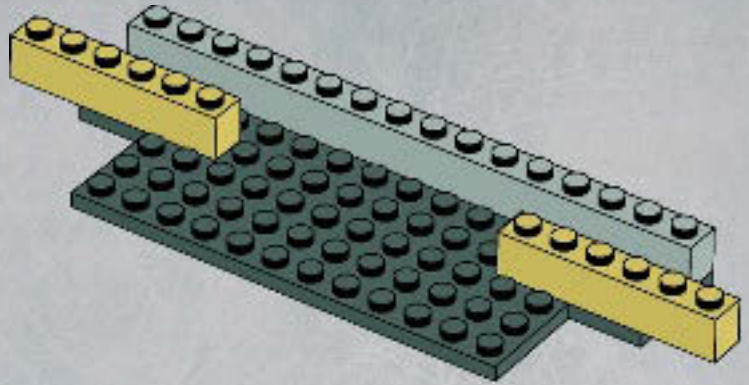

2x

4

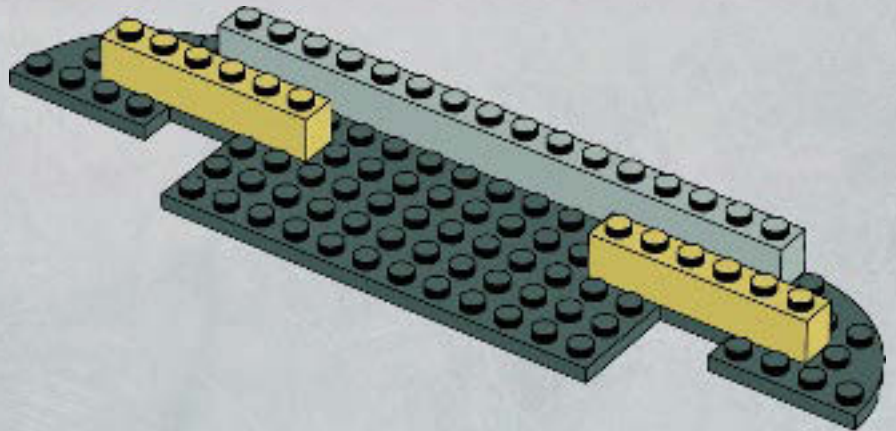

1x



2x

5

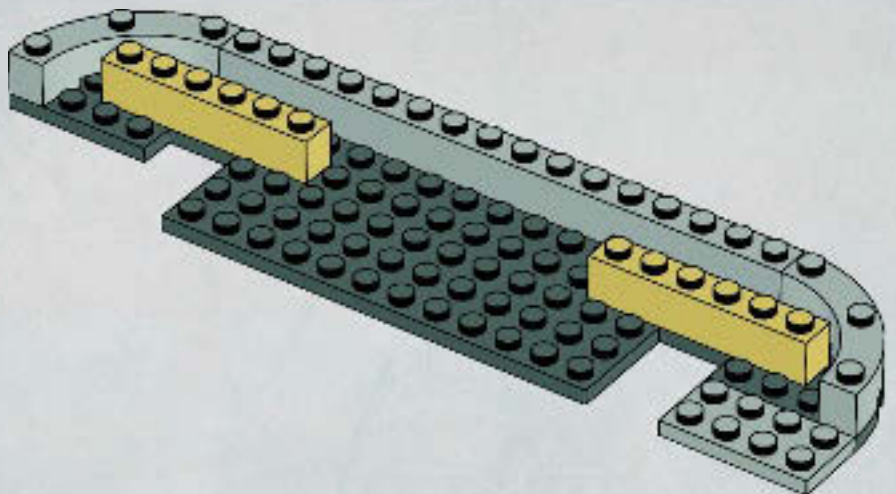



2x



1x

# 6

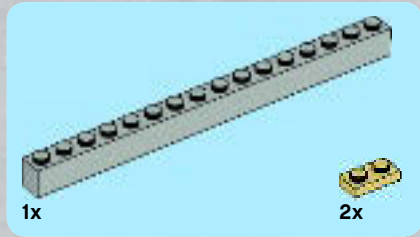
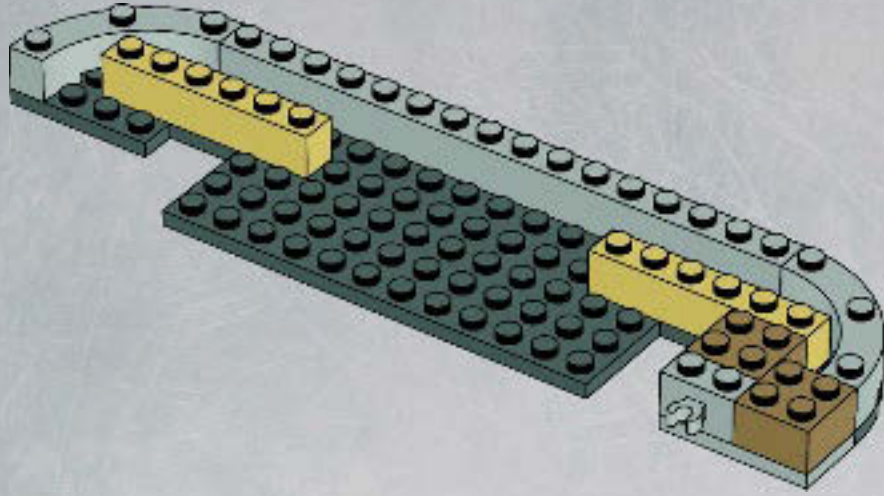

# 7

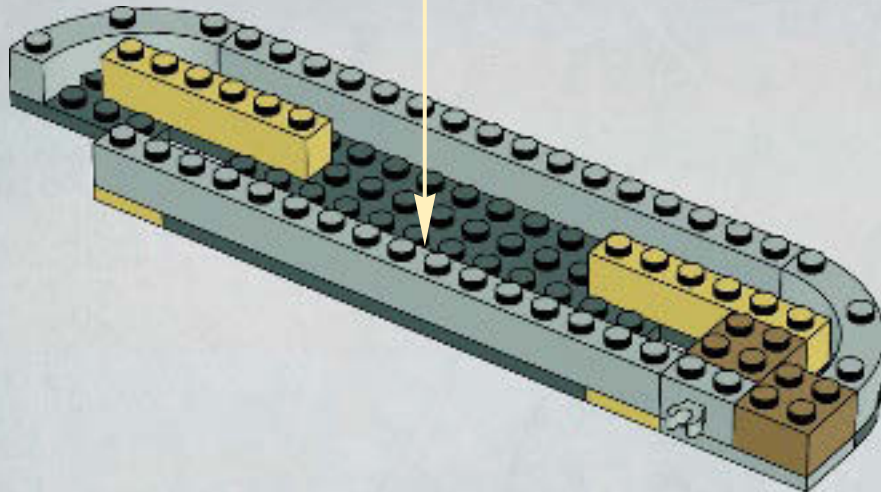
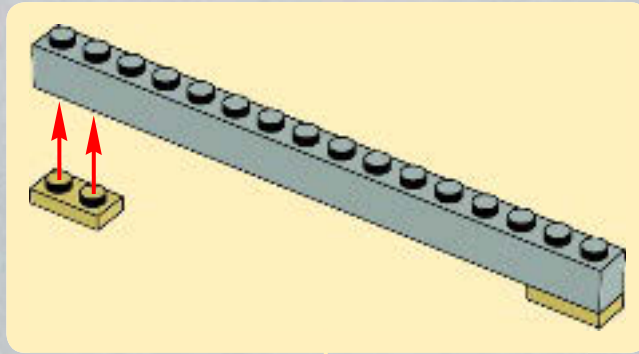



1x

8

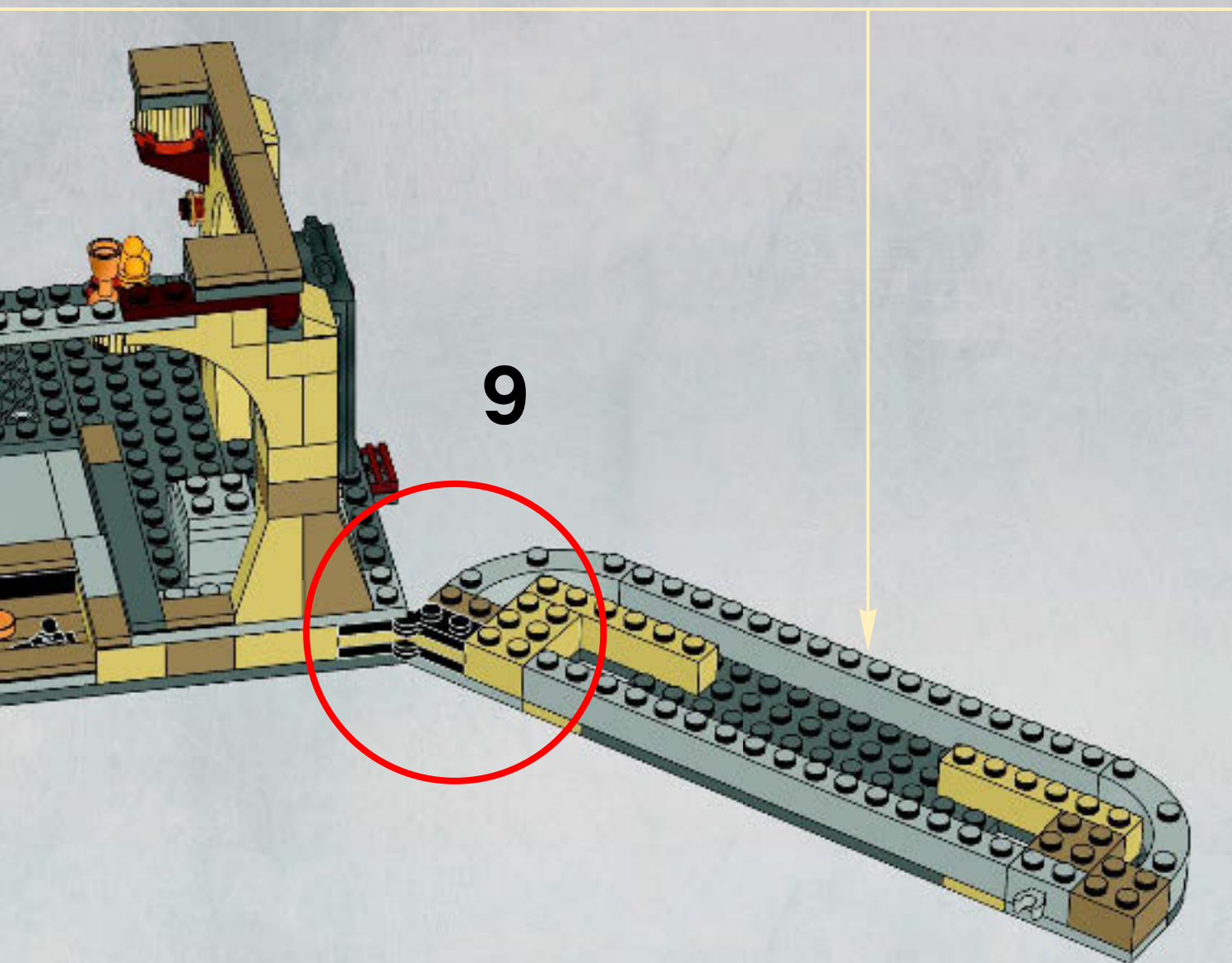
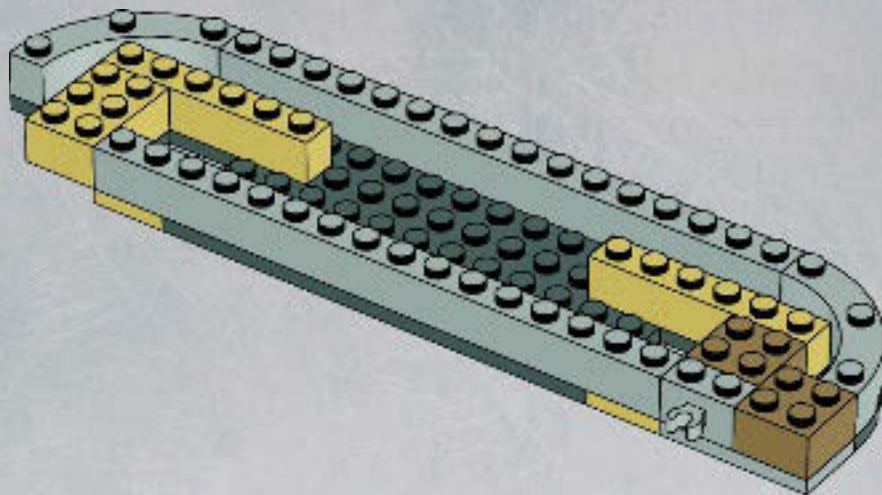

9

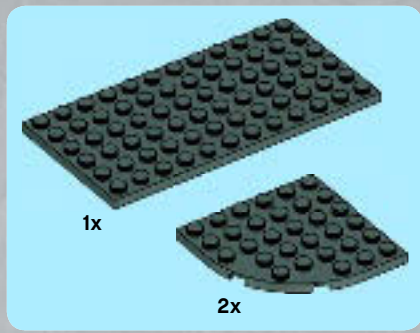

10

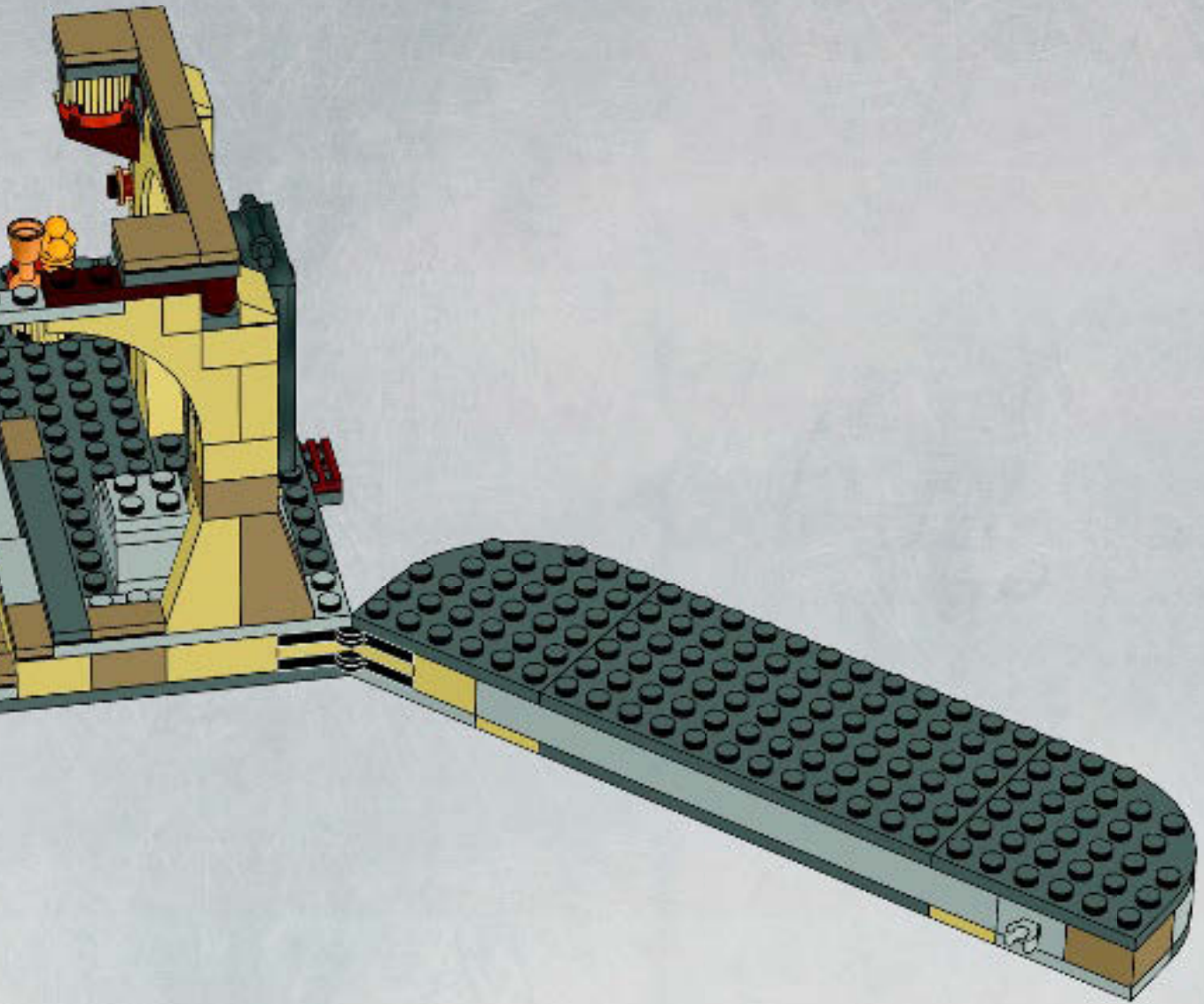

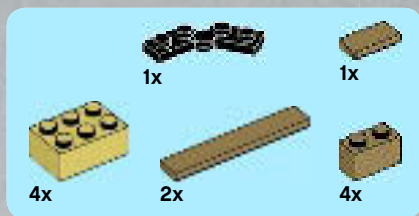

11

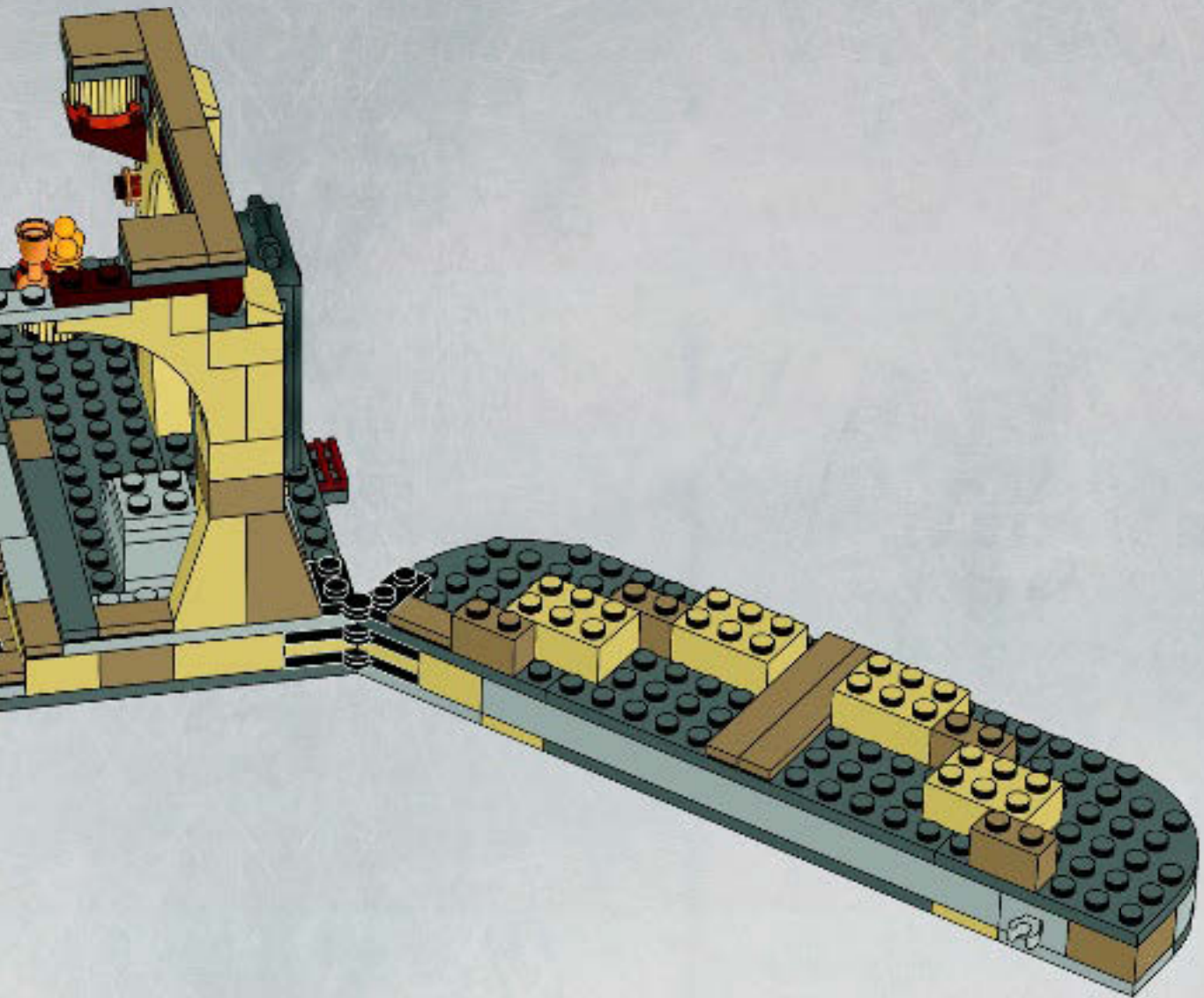

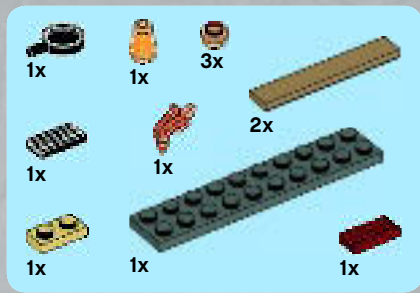

# 12

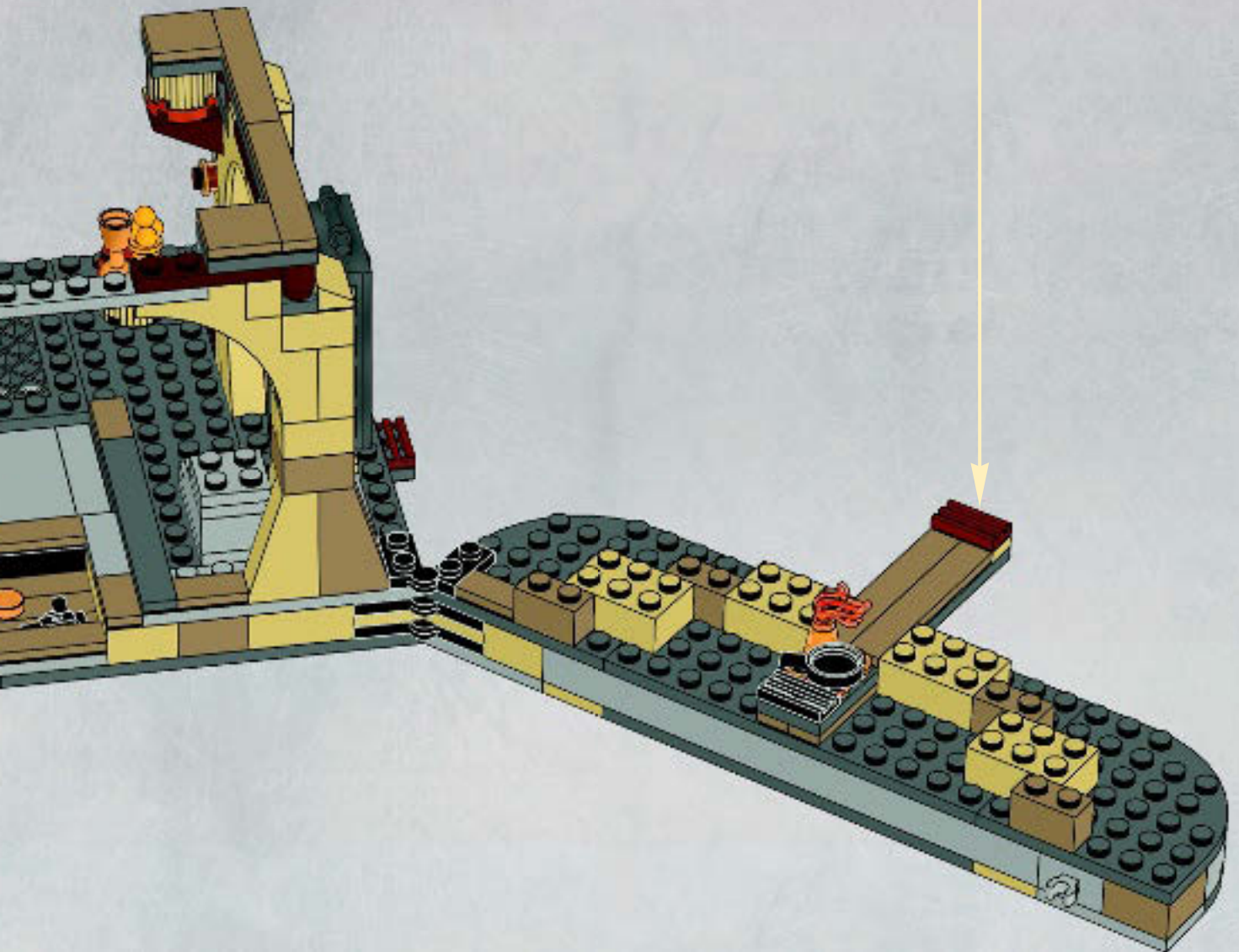
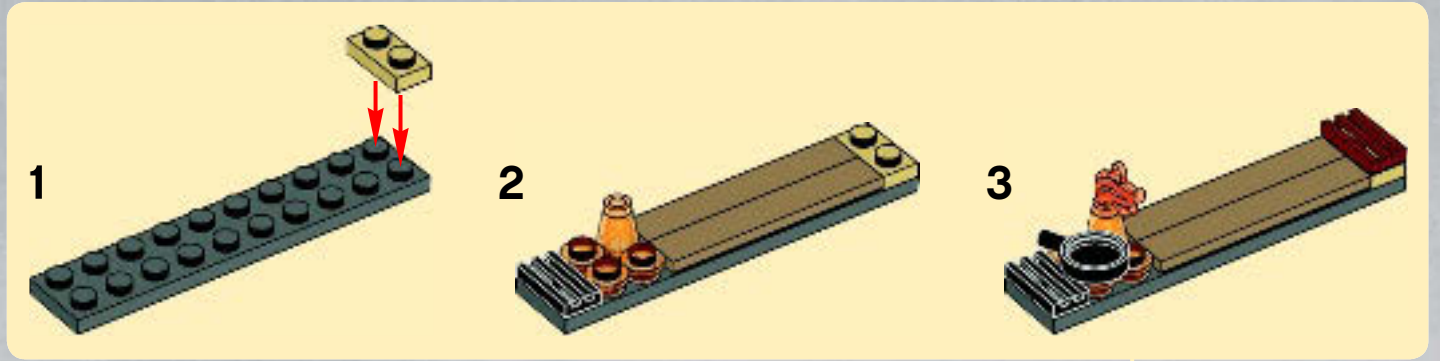



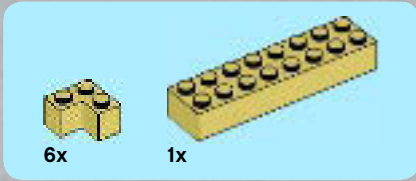

6x  
1x

# 13

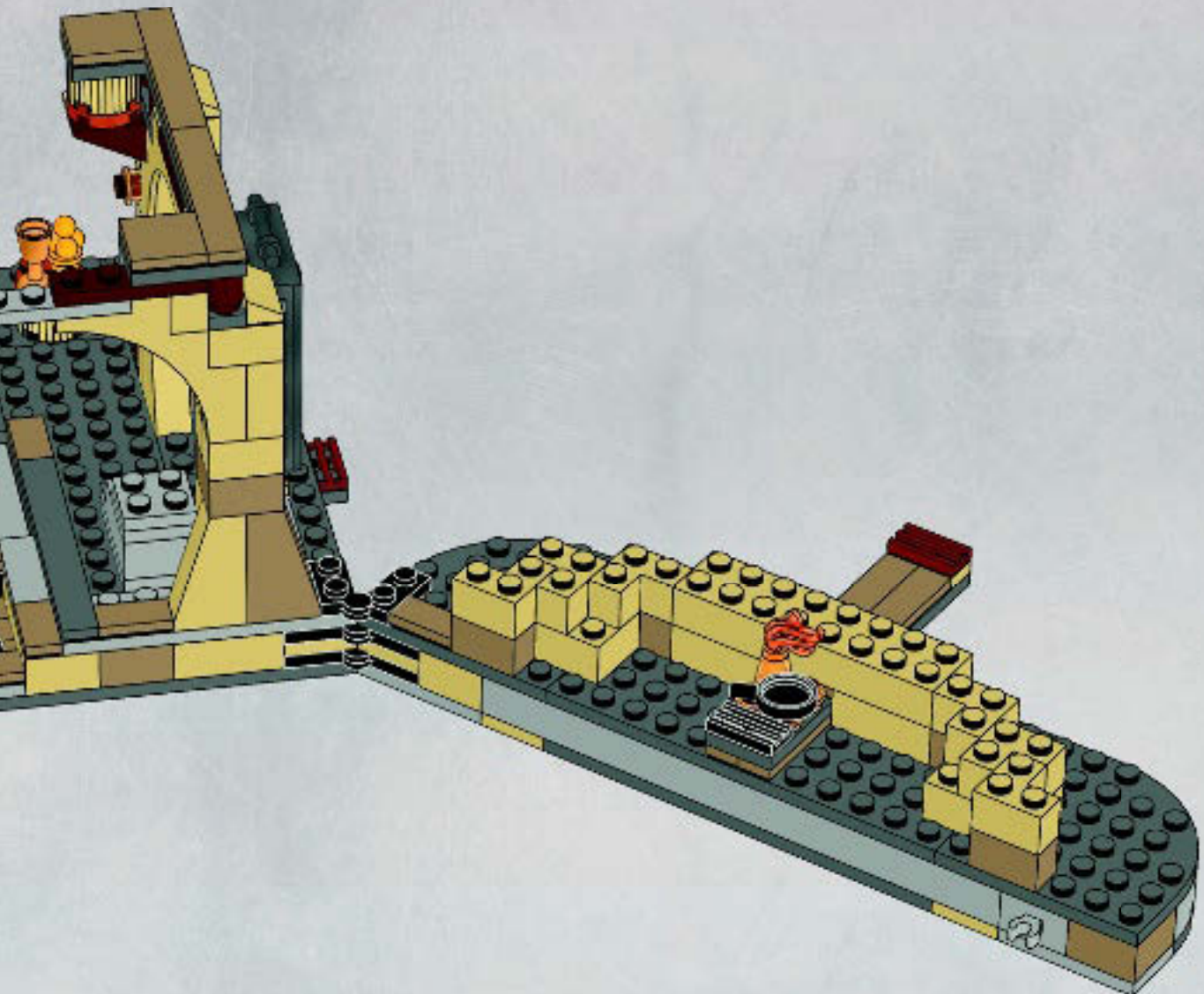

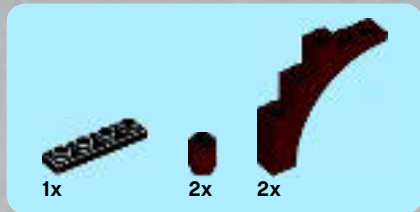

14

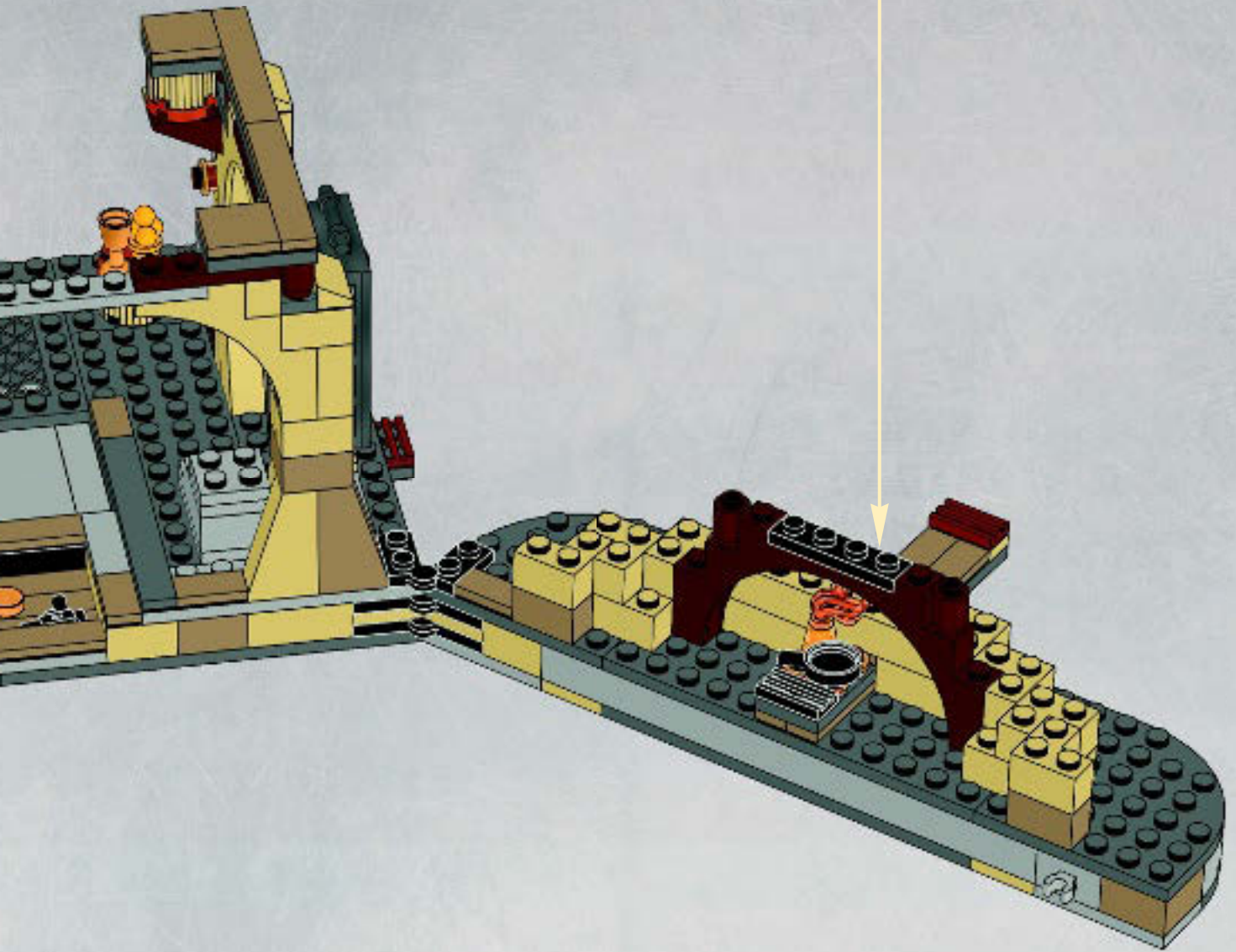
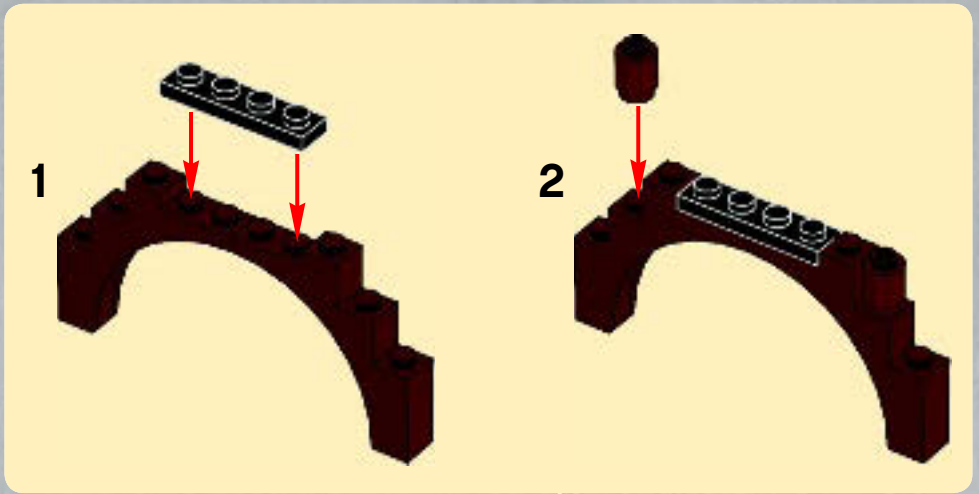



8x

15

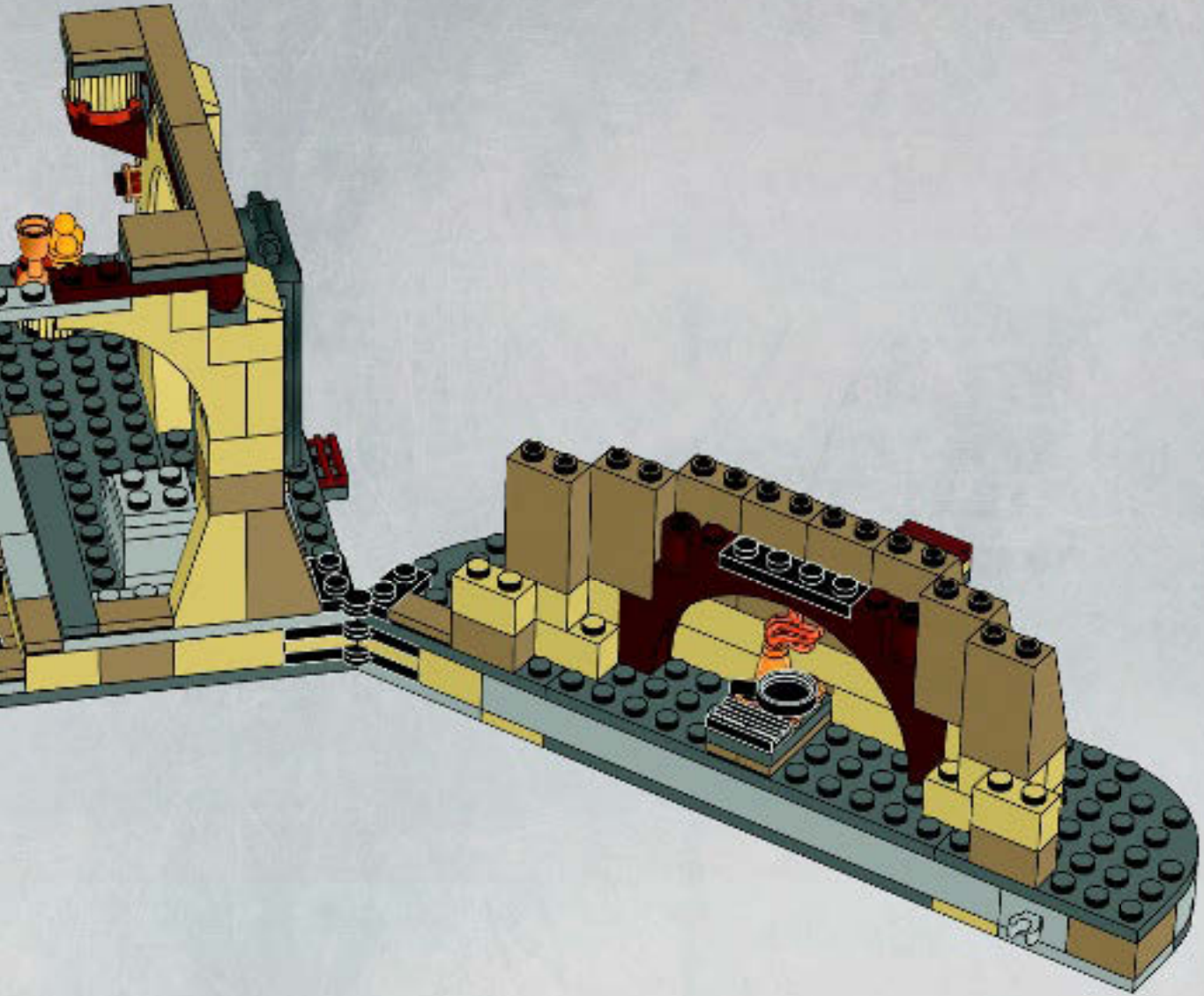



2x



4x

# 16

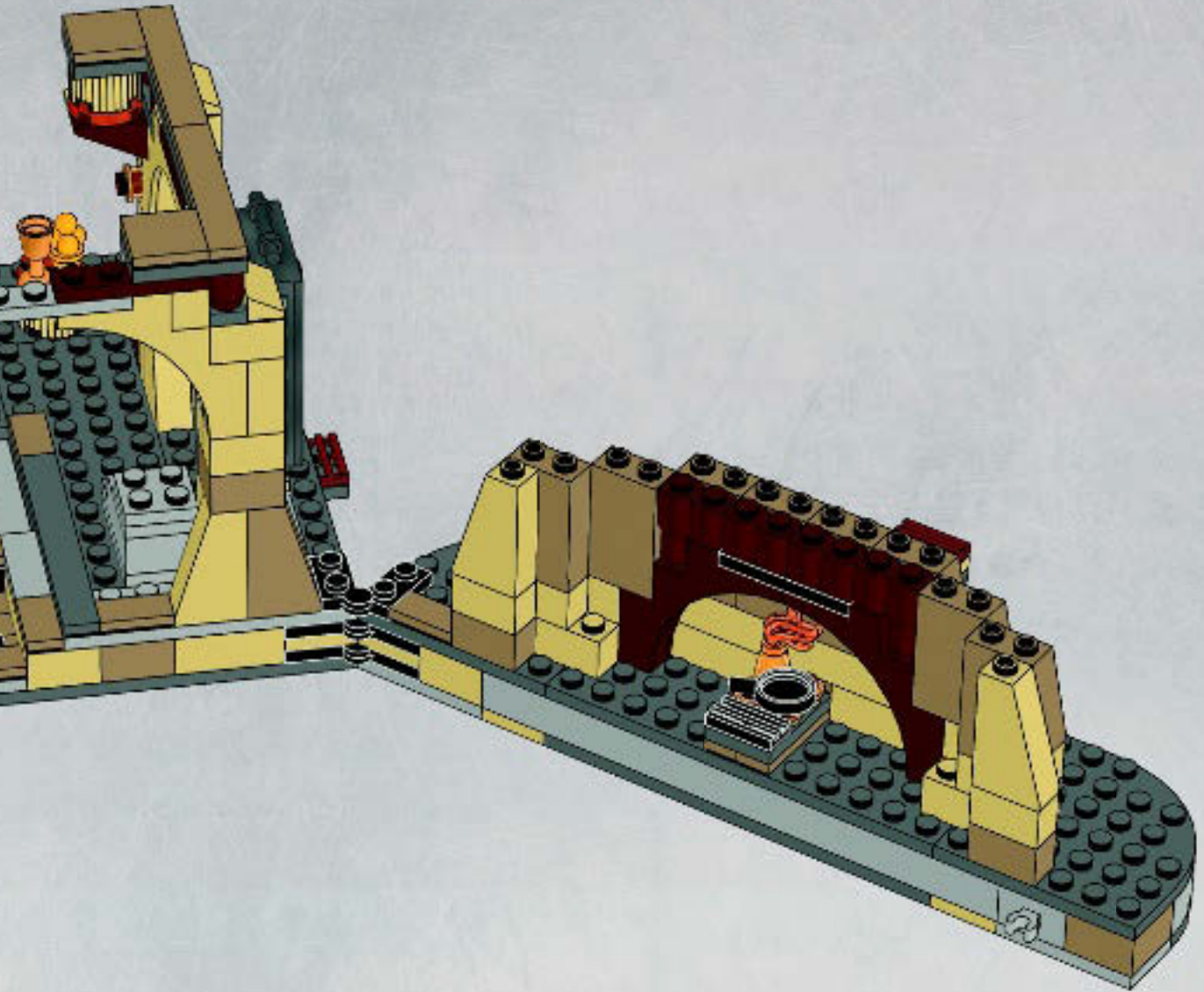



8x

17

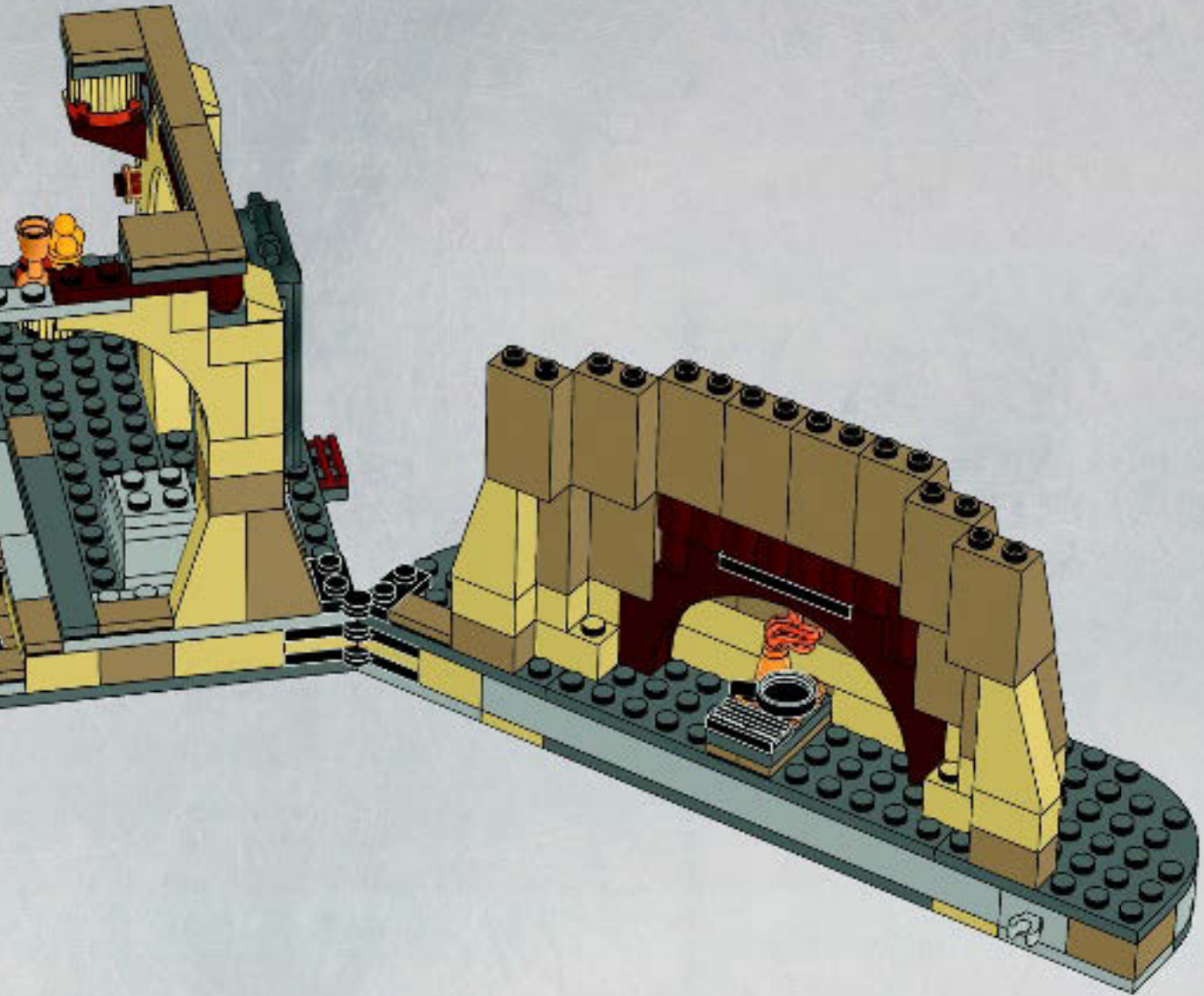



1x



4x

# 18

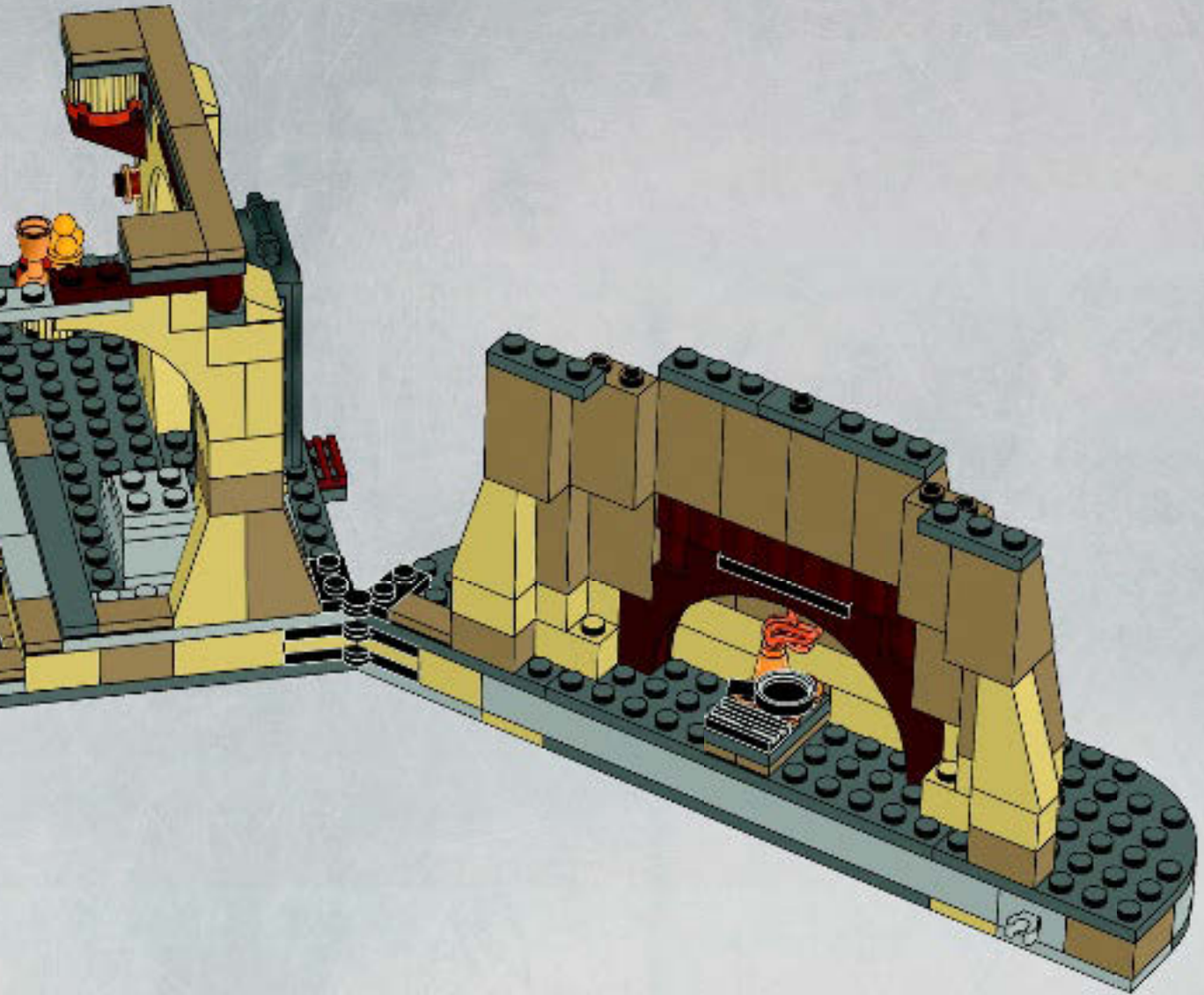



2x

# 19

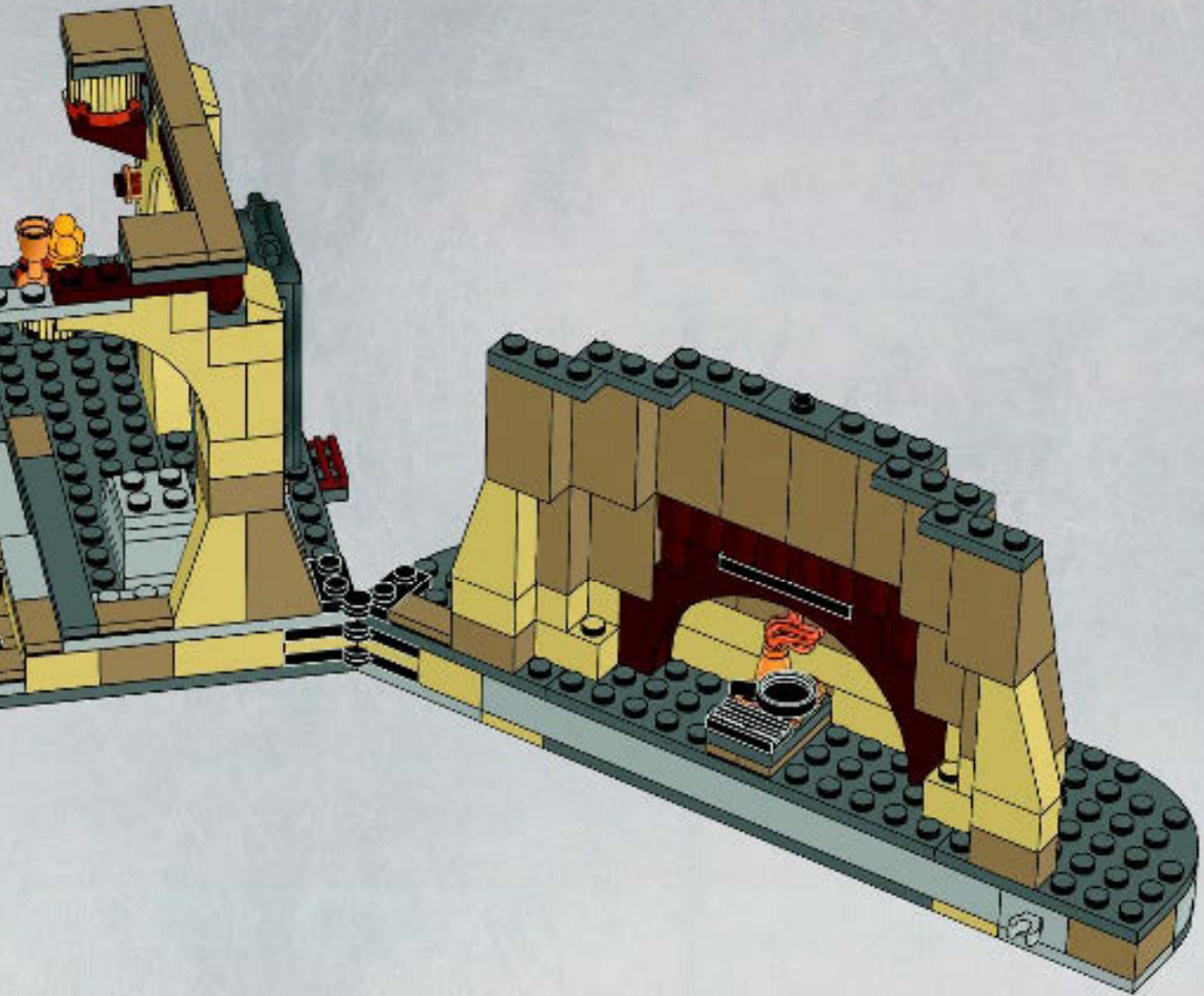



4x



5x

# 20

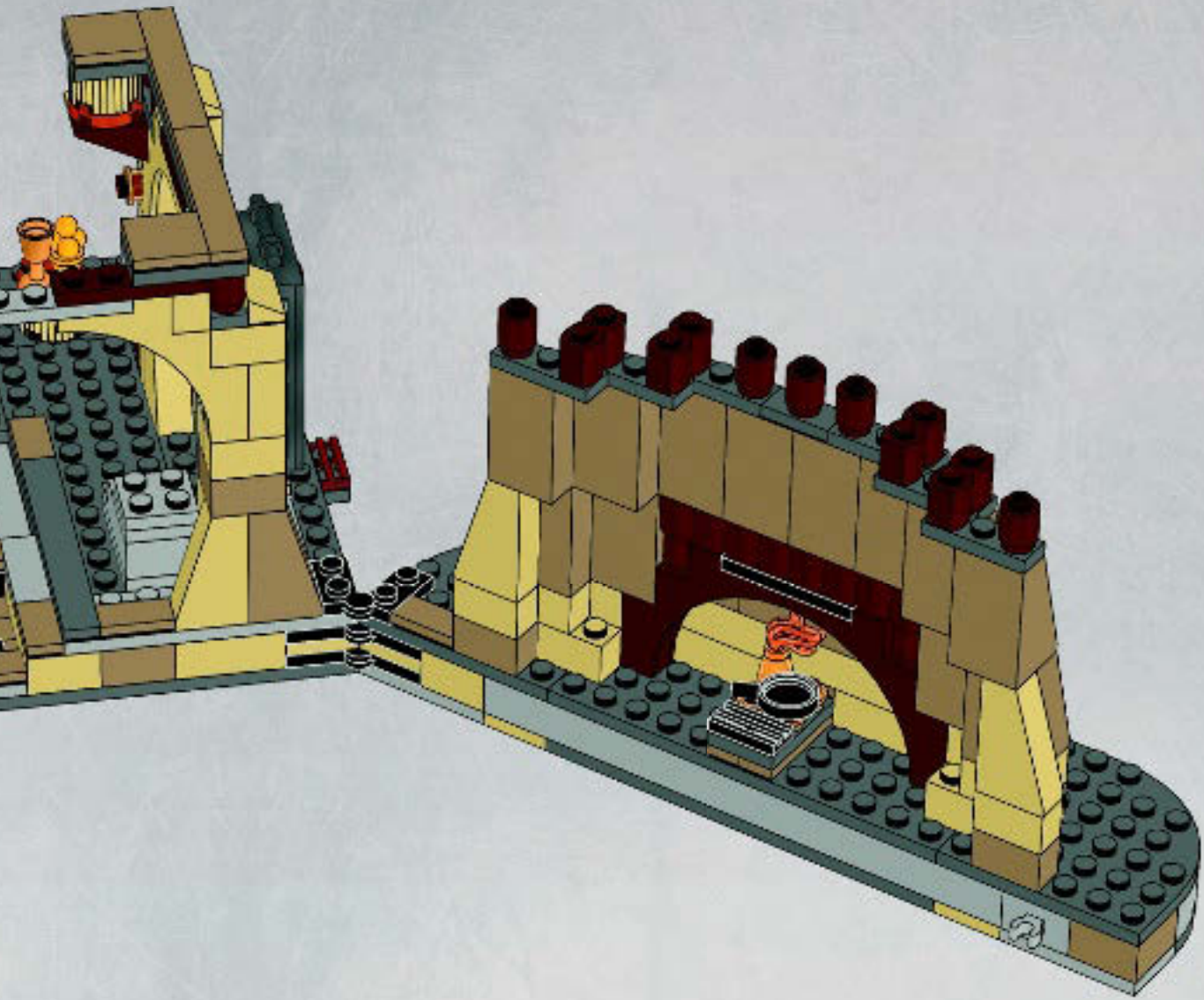





21

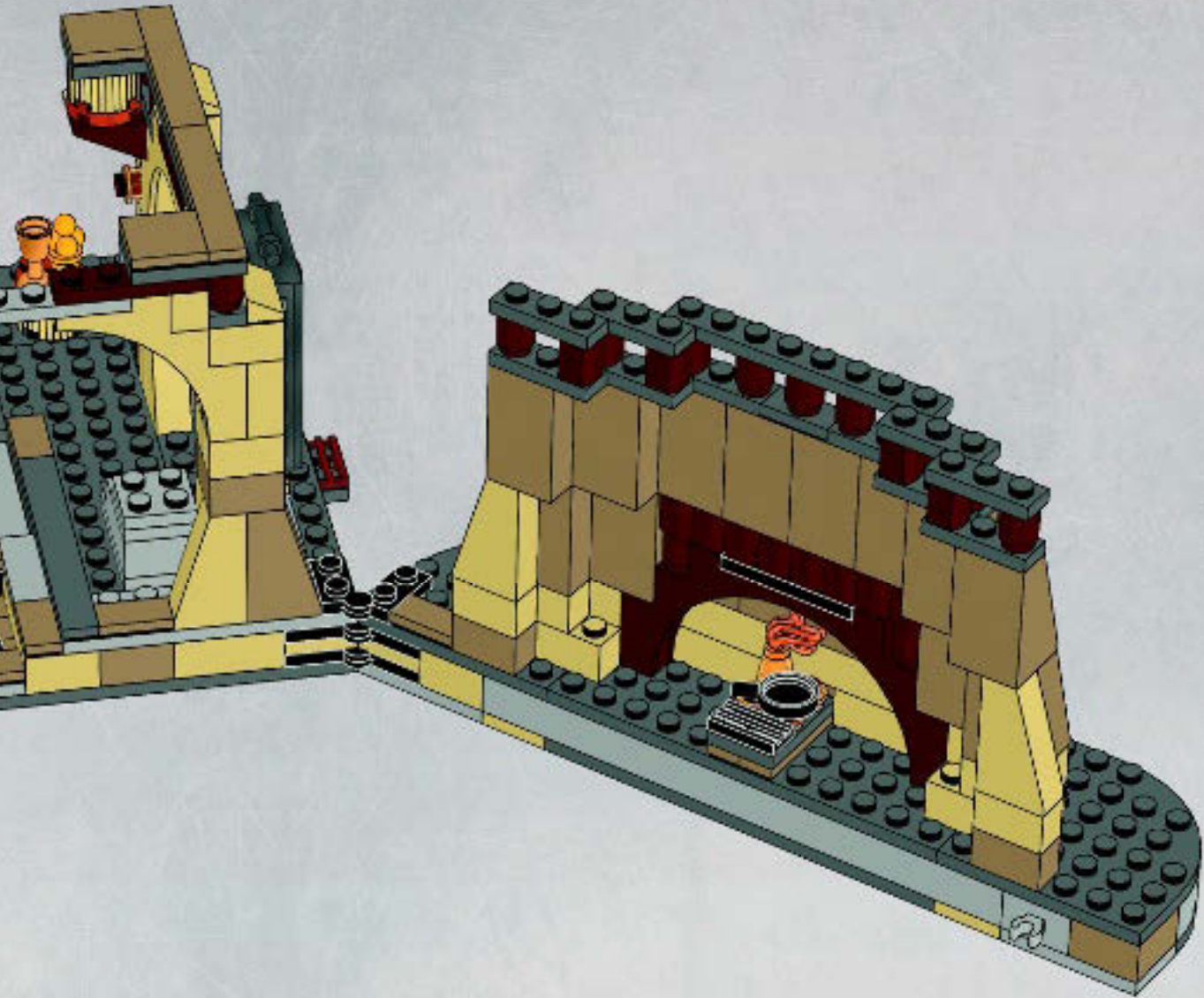



6x



1x

# 22

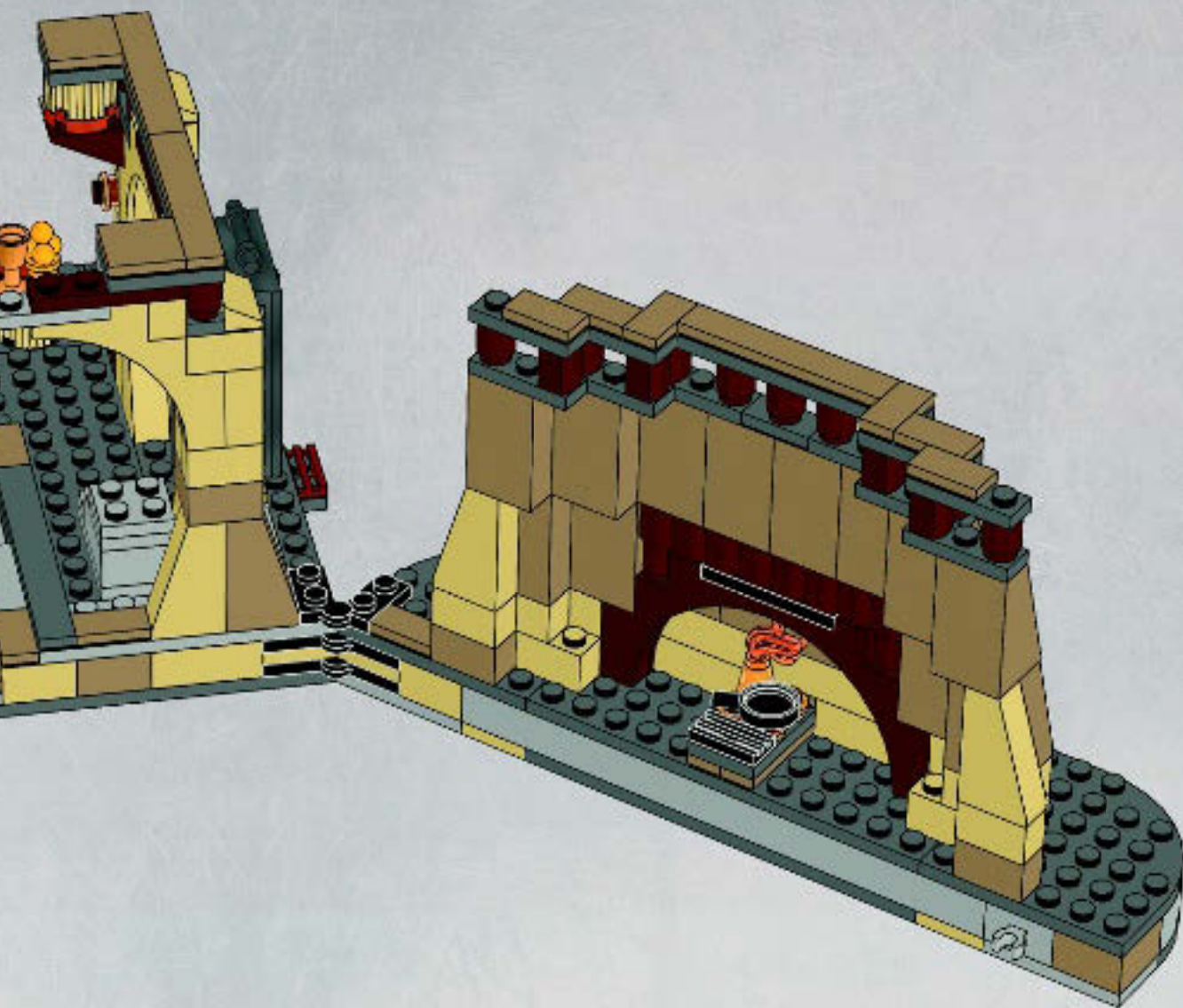

23

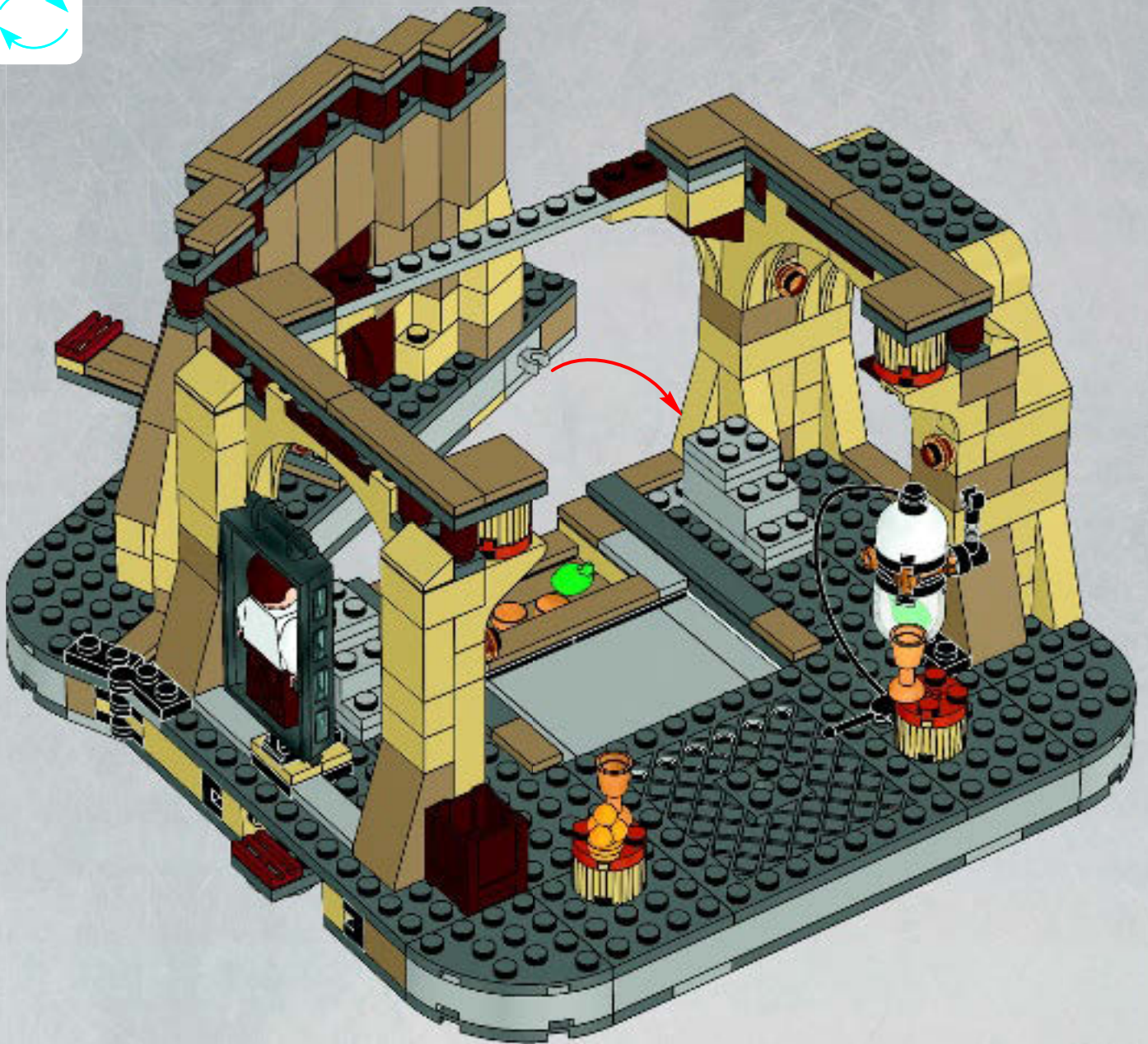

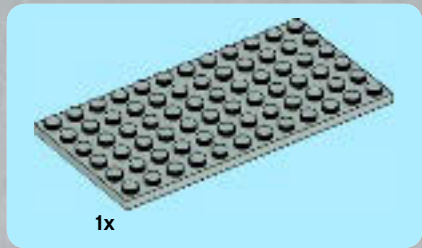

1

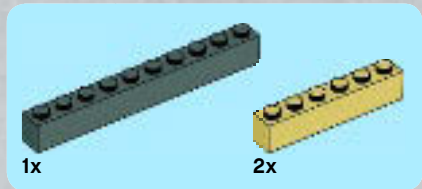
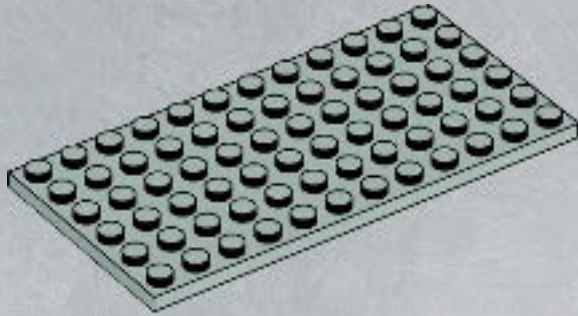

2

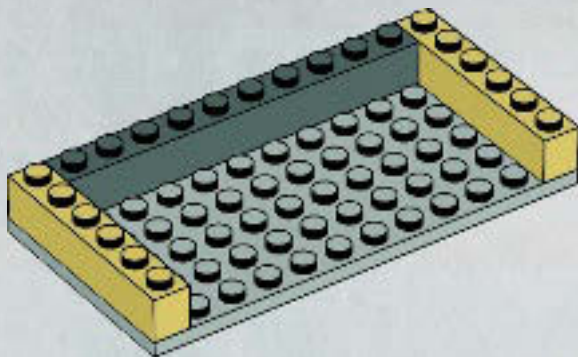

3

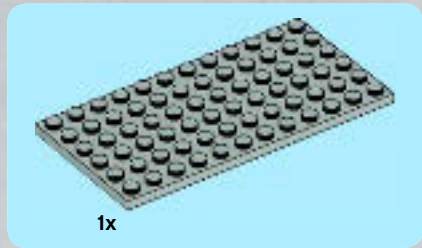
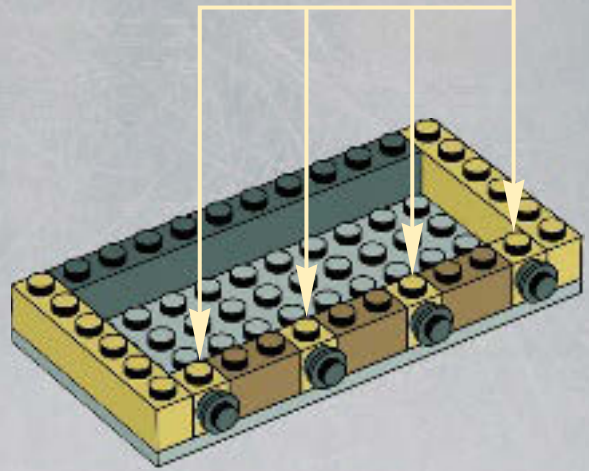
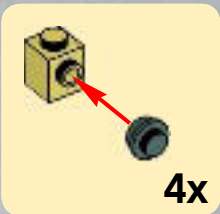

4

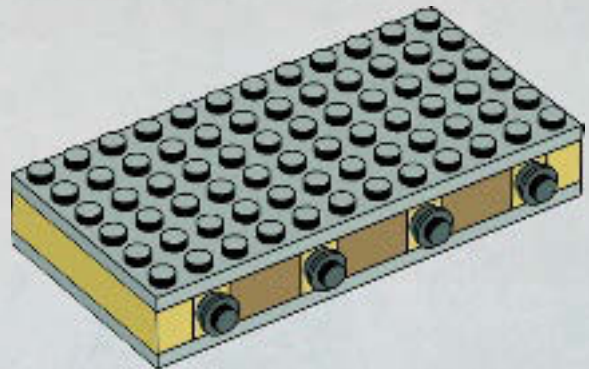



5

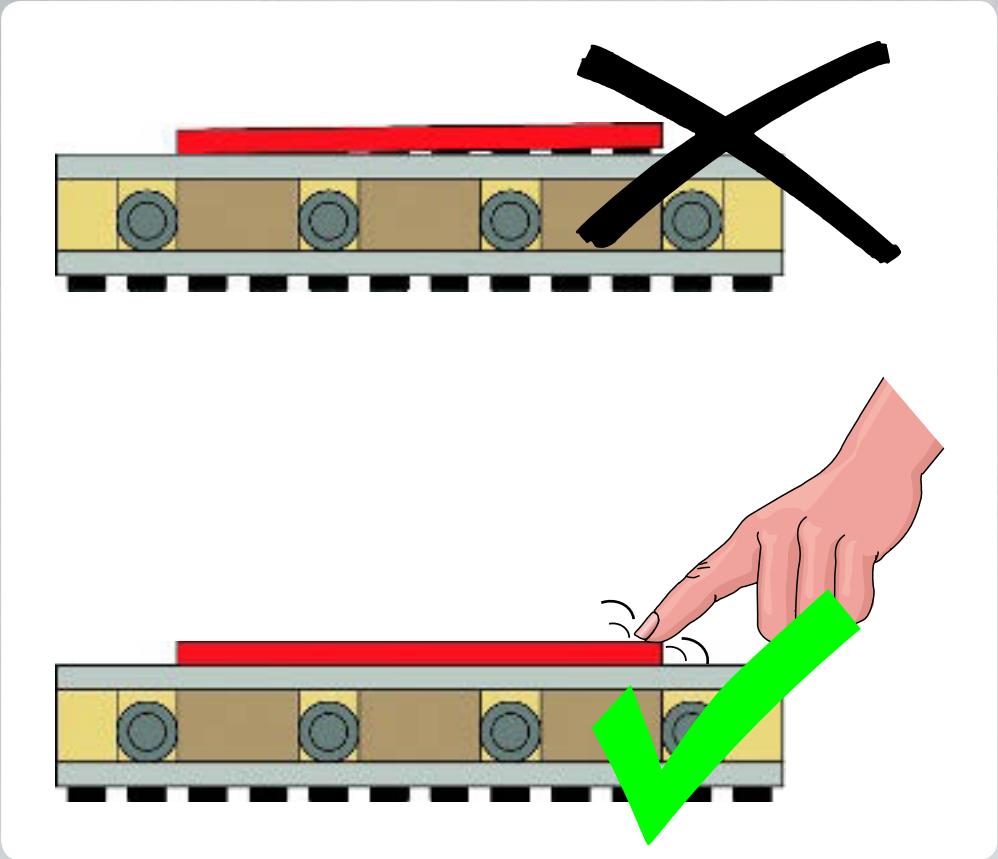
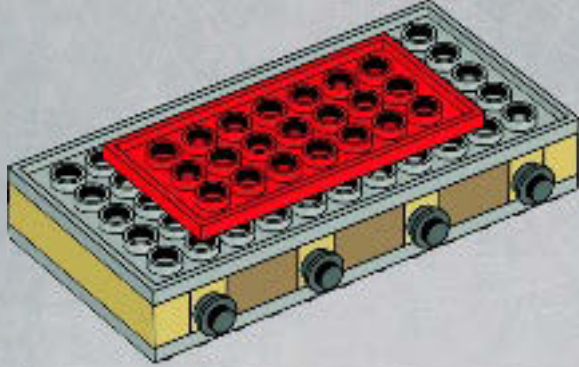

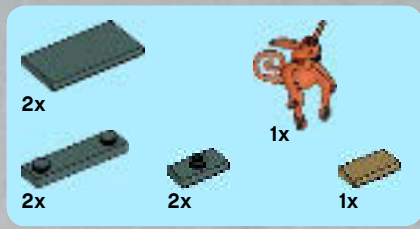

6

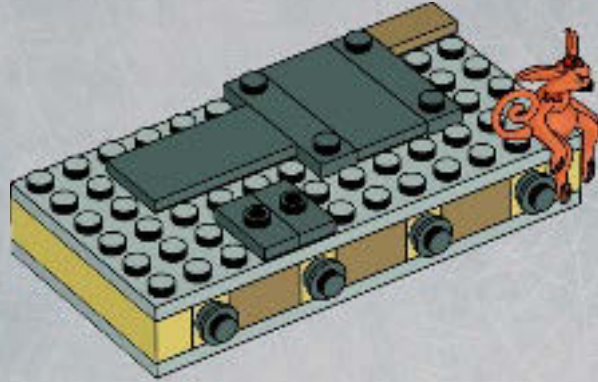

24

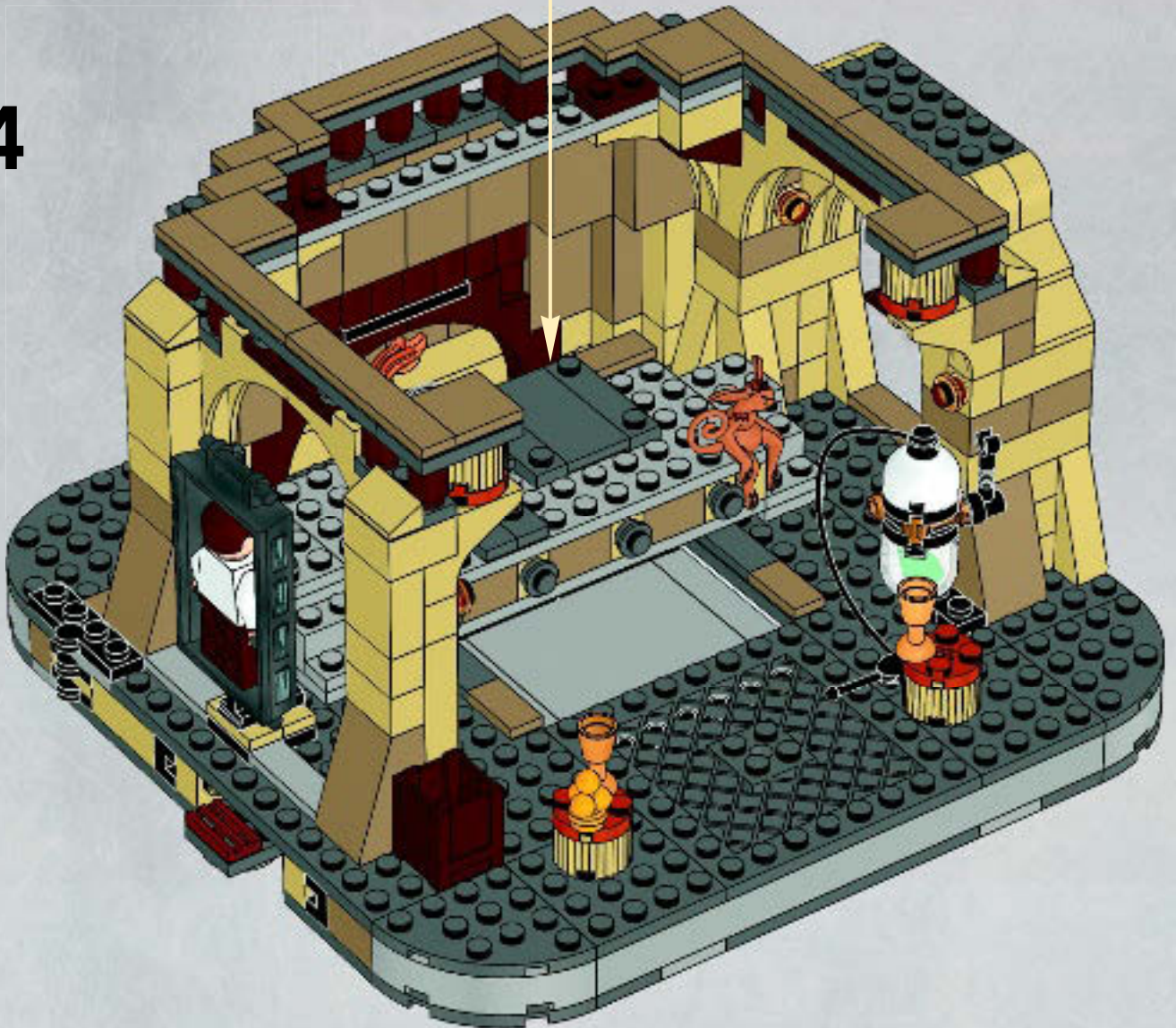

25





7

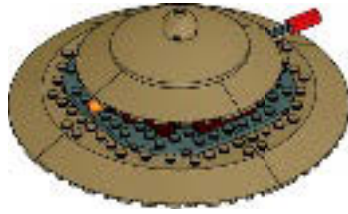

2x

1

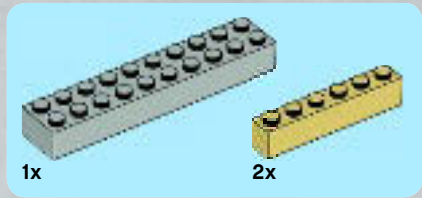
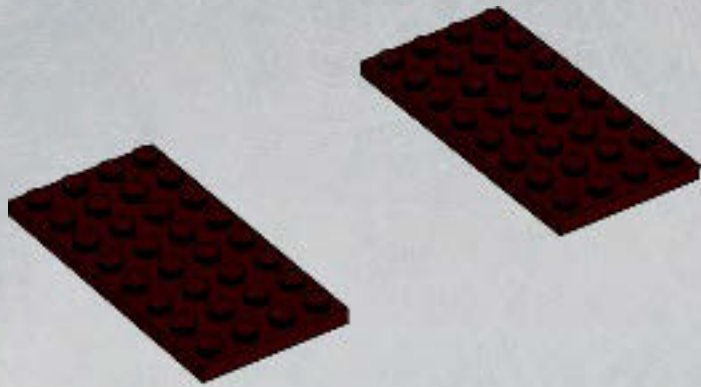

1x

2x

2

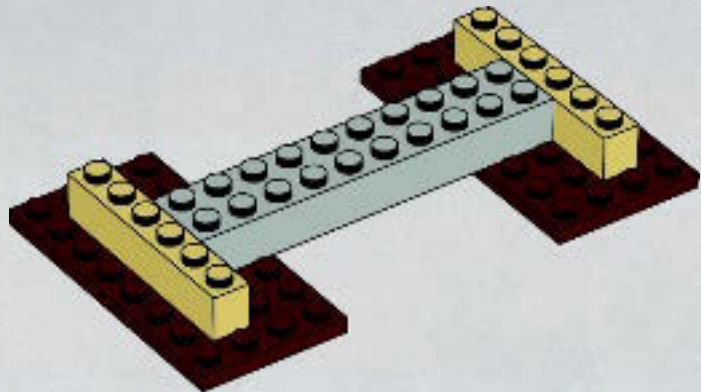



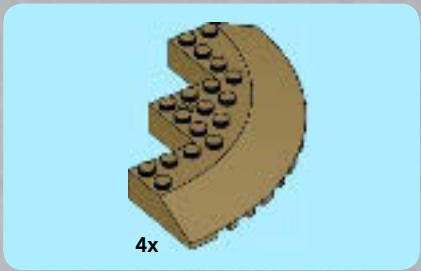

3

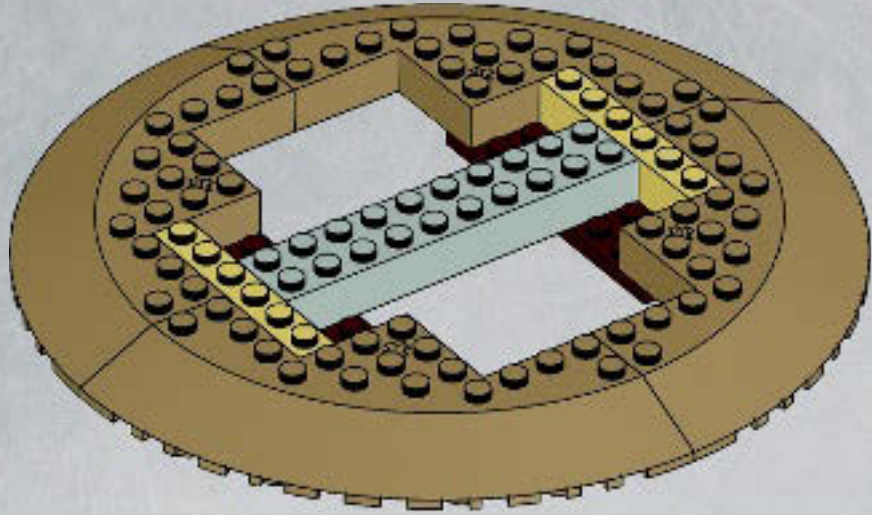

4

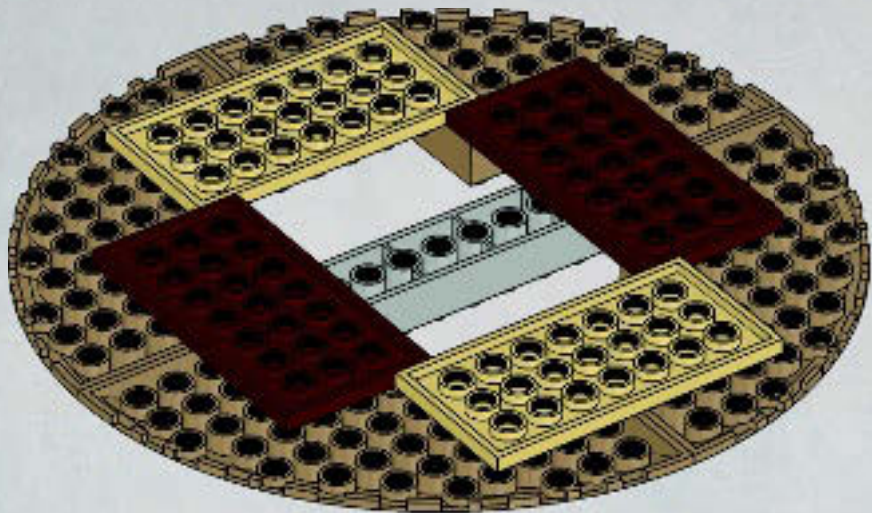



2x



5

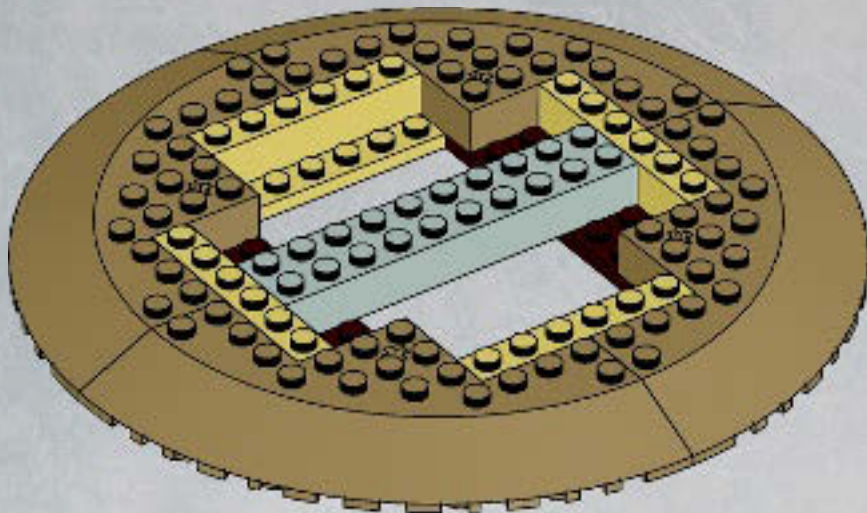

2x

6

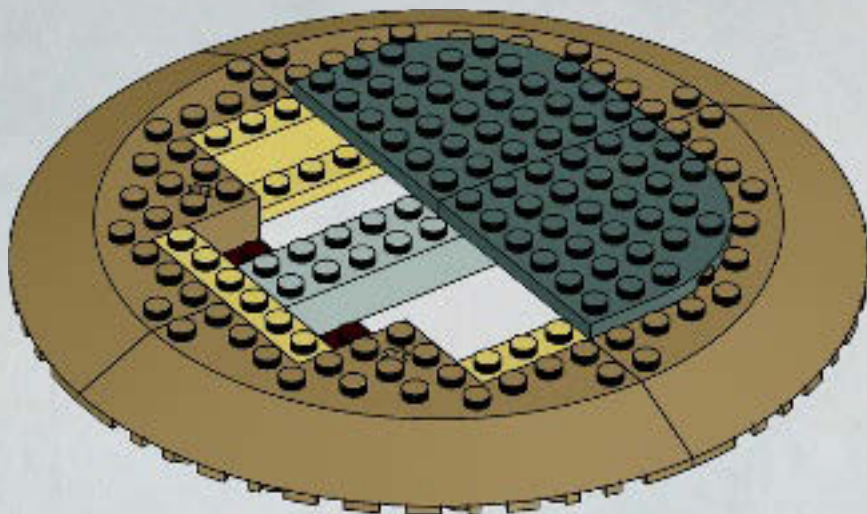

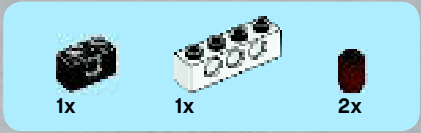

7

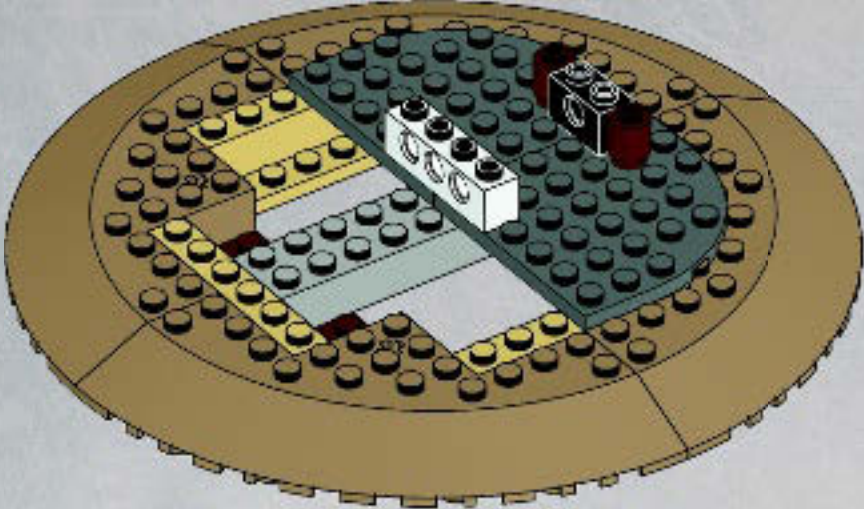

8

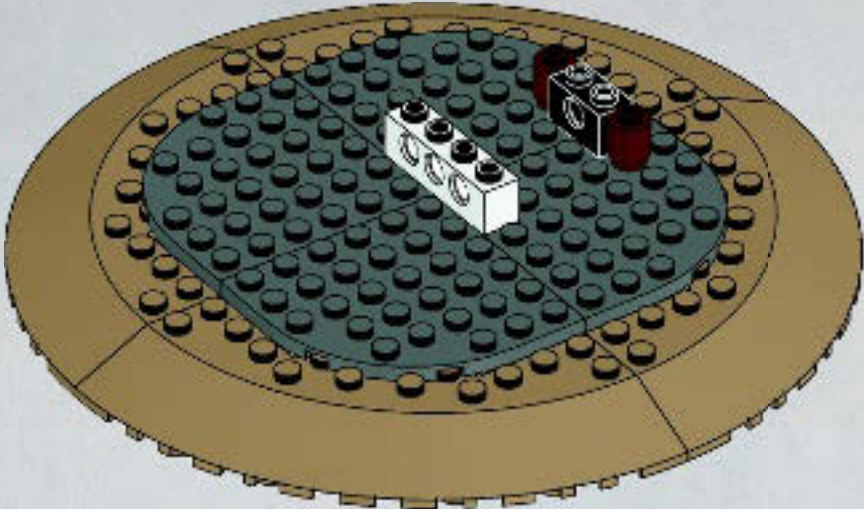

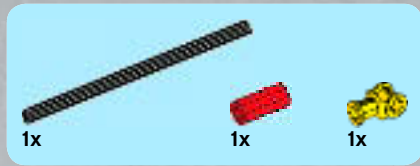

9

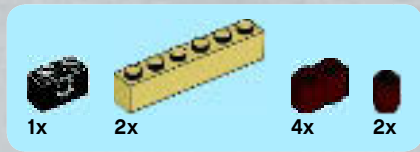
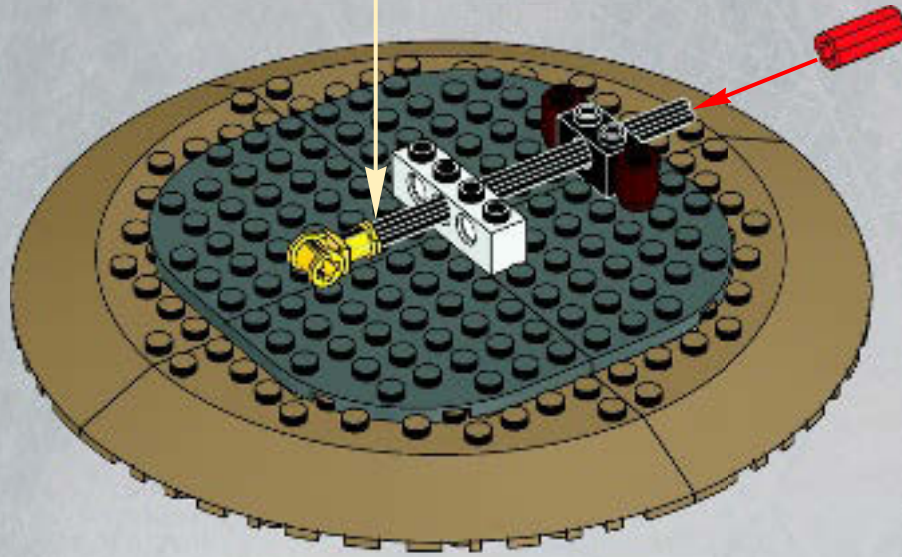
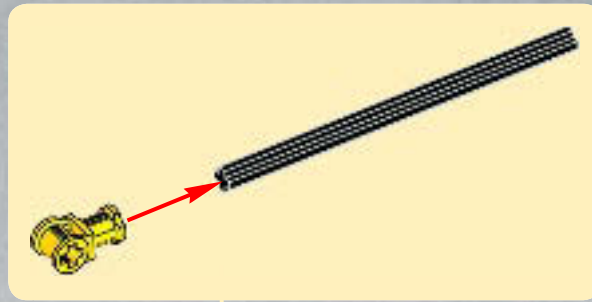

10

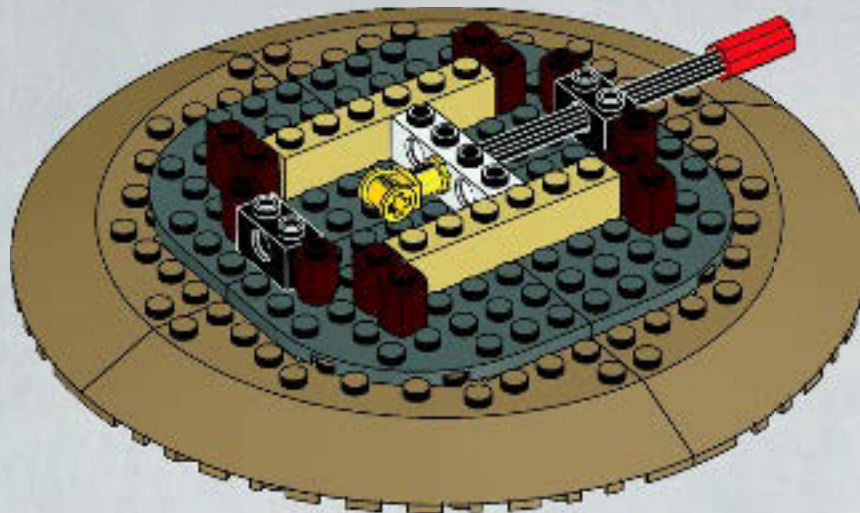



4x



1x



1x



# 11

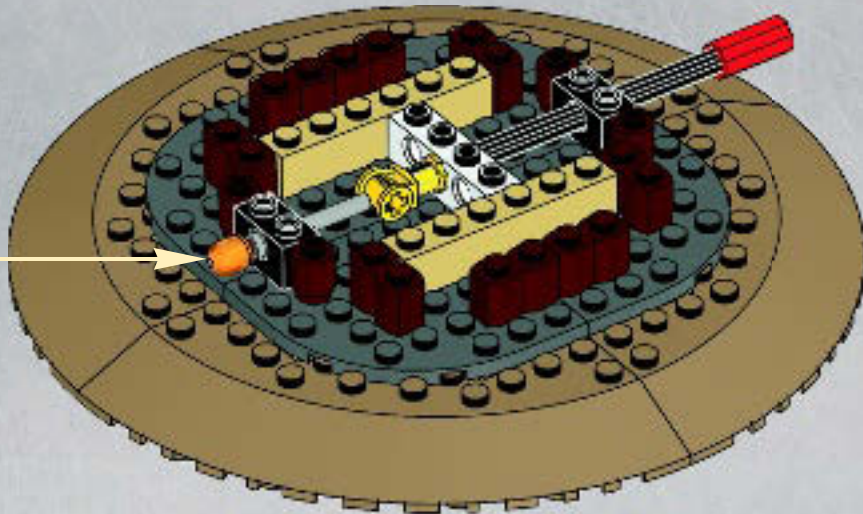
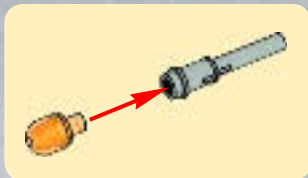

4x



# 12

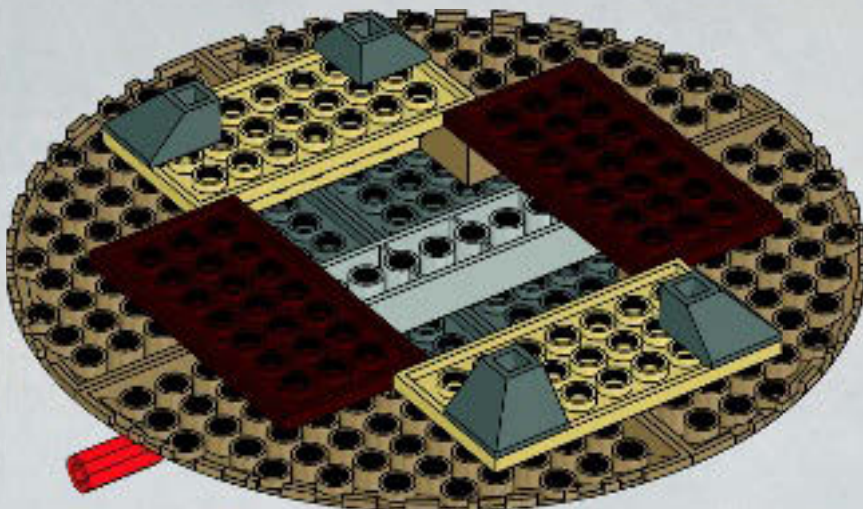

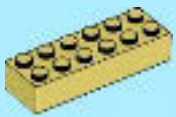

1x



# 13

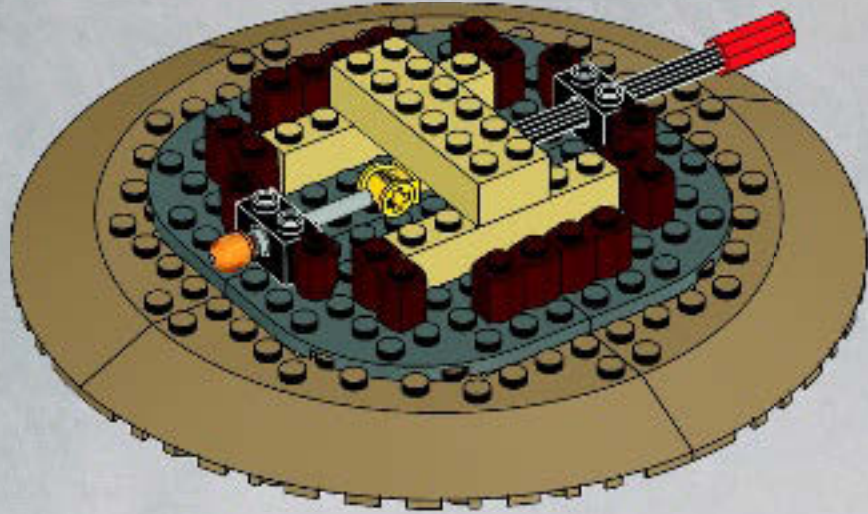

4x

# 14

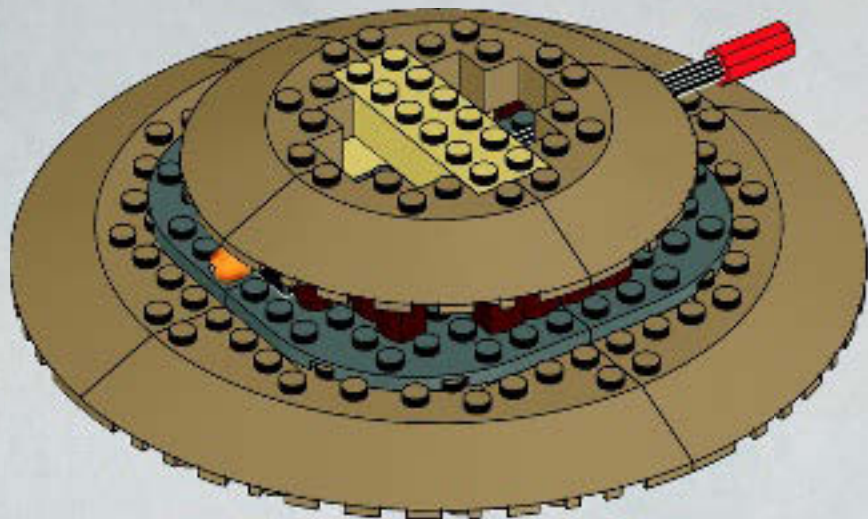



2x

# 15

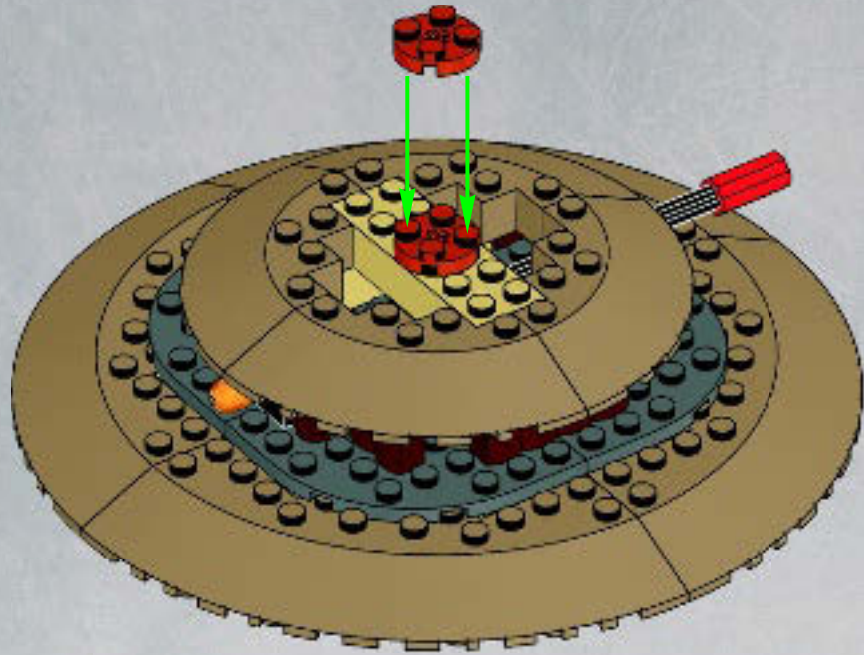

1x



1x

# 16

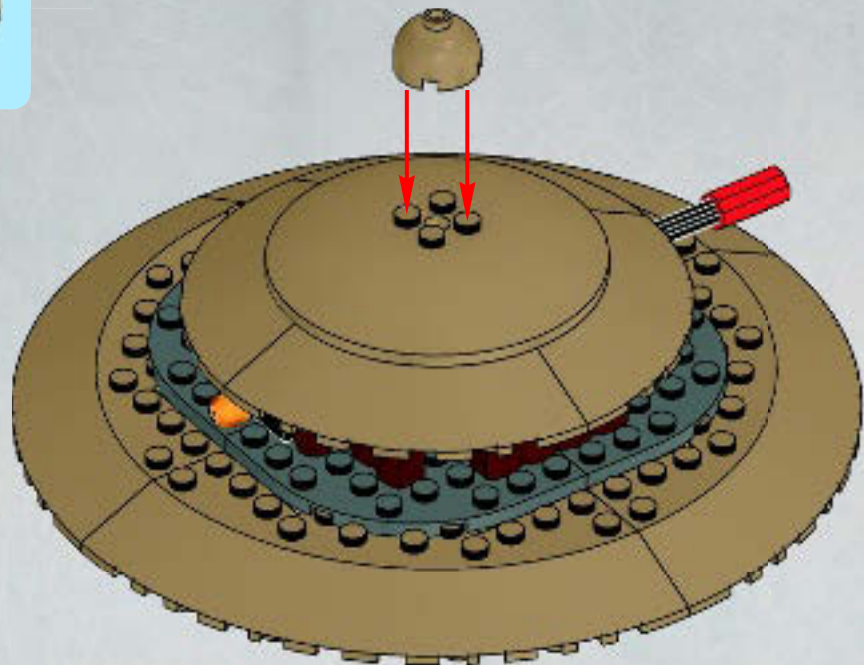

17





18

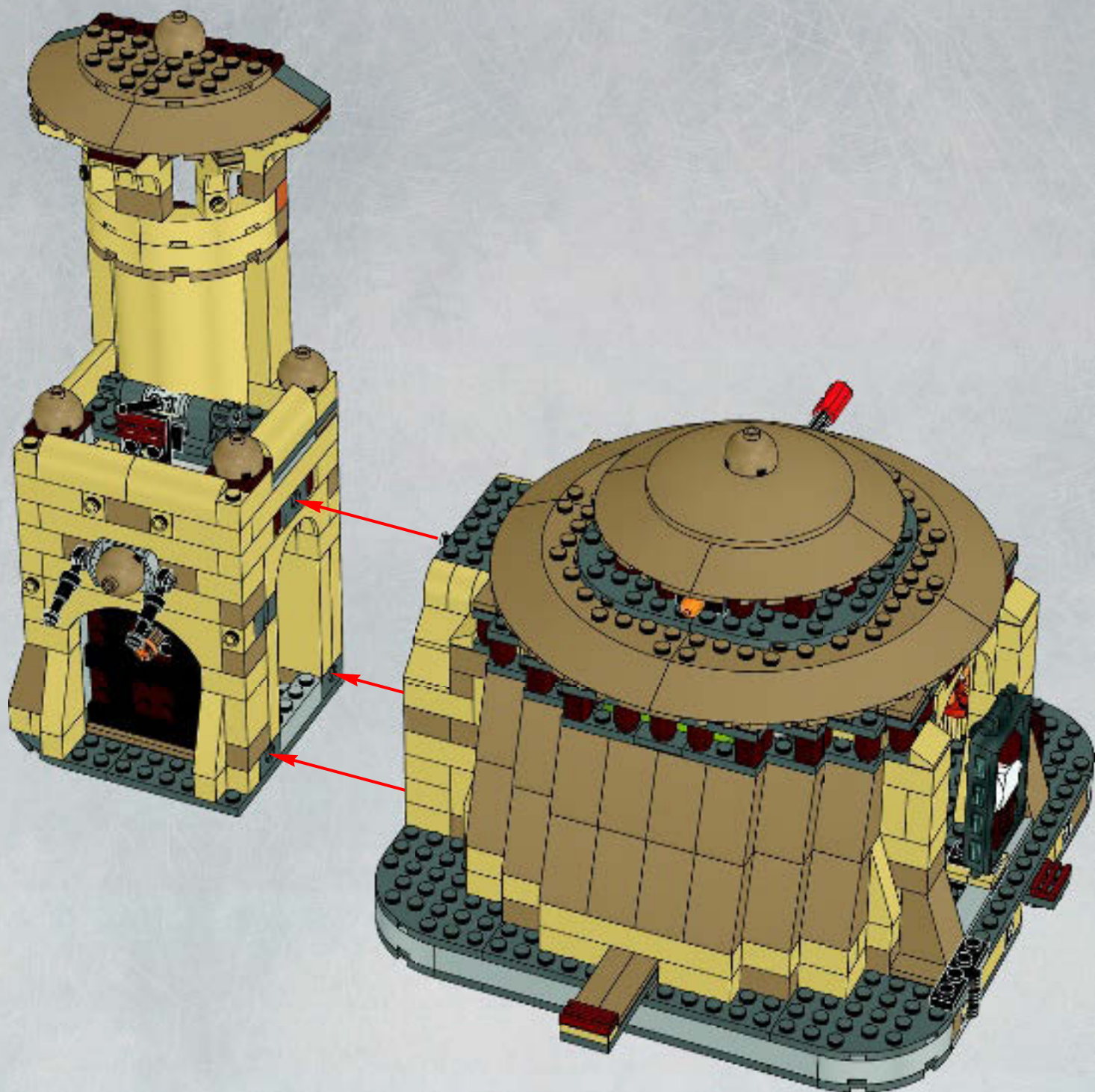





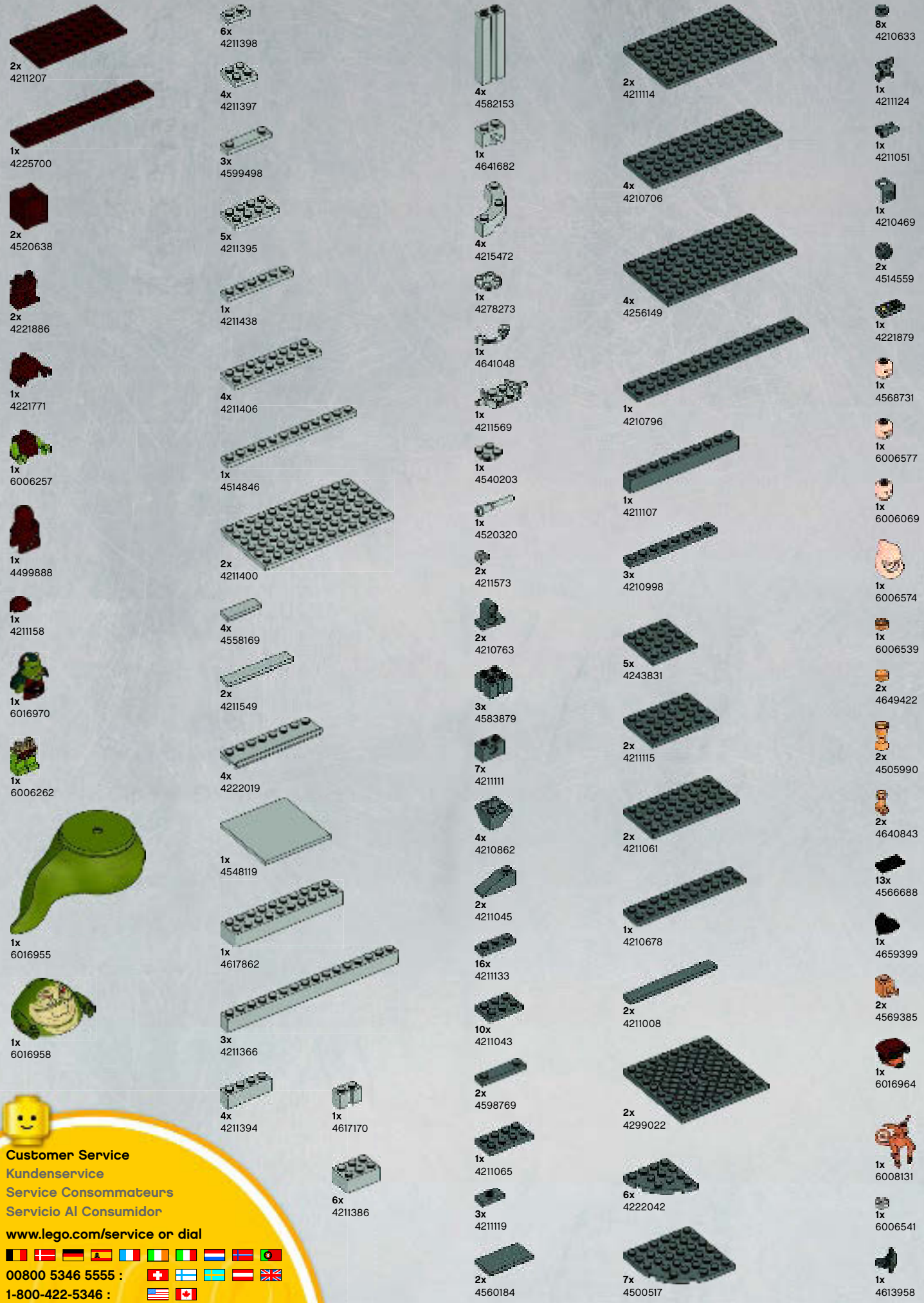

2x  
4211207

1x  
4225700

2x  
4520638

2x  
4221886

1x  
4221771

1x  
6006257

1x  
4499888

1x  
4211158

1x  
6016970

1x  
6006262

1x  
6016955

1x  
6016958

6x  
4211398

4x  
4211397

3x  
4599498

5x  
4211395

1x  
4211438

4x  
4211406

1x  
4514846

2x  
4211400

4x  
4558169

2x  
4211549

4x  
4222019

1x  
4548119

1x  
4617862

3x  
4211366

4x  
4211394

1x  
4617170

6x  
4211386

4x  
4582153

1x  
4641682

4x  
4215472

1x  
4278273

1x  
4641048

1x  
4211569

1x  
4540203

1x  
4520320

2x  
4211573

2x  
4210763

3x  
4583879

7x  
4211111

4x  
4210862

2x  
4211045

16x  
4211133

10x  
4211043

2x  
4598769

1x  
4211065

3x  
4211119

2x  
4560184

2x  
4211114

4x  
4210706

4x  
4256149

1x  
4210796

1x  
4211107

3x  
4210998

5x  
4243831

2x  
4211115

2x  
4211061

1x  
4210678

2x  
4211008

2x  
4299022

6x  
4222042

7x  
4500517

8x  
4210633

1x  
4211124

1x  
4211051

1x  
4210469

2x  
4514559

1x  
4221879

1x  
4568731

1x  
6006577

1x  
6006069

1x  
6006574

1x  
6006539

2x  
4649422

2x  
4505990

2x  
4640843

13x  
4566688

1x  
4659399

2x  
4569385

1x  
6016964

1x  
6008131

1x  
6006541

1x  
4613958



**Customer Service**  
**Kundenservice**  
**Service Consommateurs**  
**Servicio Al Consumidor**

[www.lego.com/service](http://www.lego.com/service) or dial

00800 5346 5555 : 

1-800-422-5346 : 



JABBA THE HUTT™



HAN SOLO™



HAN IN CARBONITE™



B'OMARR MONK™



BIB FORTUNA™



GAMORREAN GUARD™



CHEWBACCA™



OOLA™



BOUSHH™



SALACIOUS B. CRUMB™

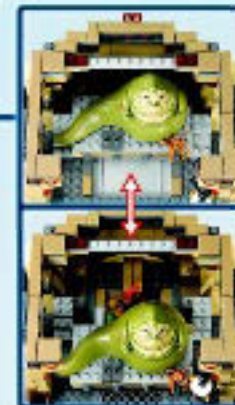
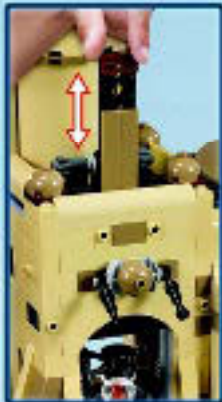





# club™

## FREE\*! GRATIS! GRATUIT!

# www.LEGOclub.com/Max



# 3



\*Paid subscription in Australia and New Zealand.  
\*Abonnement payant en Australie et Nouvelle-Zélande.



# WIN!

Go to [www.LEGOsurvey.com/product](http://www.LEGOsurvey.com/product) to fill out a survey for a chance to win a cool LEGO® Product. No purchase necessary. Open to all residents where not prohibited.



[www.LEGO.com](http://www.LEGO.com)



## [www.LEGOsurvey.com/product](http://www.LEGOsurvey.com/product)

### GEWINNE!

Nimm an der Umfrage auf [www.LEGOsurvey.com/product](http://www.LEGOsurvey.com/product) teil und hab die Chance ein cooles LEGO® Produkt zu gewinnen! Die Teilnahme am Gewinnspiel führt zu keinerlei Kaufverpflichtungen. Teilnahme in allen nicht ausgeschlossenen Ländern möglich.

### WIN!

Ga naar [www.LEGOsurvey.com/product](http://www.LEGOsurvey.com/product), vul een enquêteformulier in en maak kans op een cool LEGO® product. Geen aankoopverplichting. Iedereen mag deelnemen, uitgezonderd ingezetenden van landen waar een enquêteverbod geldt.

### GAGNE!

Visite [www.LEGOsurvey.com/product](http://www.LEGOsurvey.com/product) pour répondre à un questionnaire et avoir une chance de gagner un produit LEGO® très cool! Aucune obligation d'achat. Ouvert à tous les résidents des pays autorisés.

### 当てよう!

[www.LEGOsurvey.com/product](http://www.LEGOsurvey.com/product) にアクセスして、アンケートにご記入ください。当選者にはレゴ®製品を差し上げます。お買い上げの必要はありません。禁止されていない限り、すべての皆様にご利用いただけます。